



# **Expression, Purification and Characterization of Carbohydrate-Binding Proteins**

**Valerie Murphy, B. Sc**

Thesis presented for the Ph.D. Degree of the  
National University of Ireland, Galway

School of Chemistry,  
National University of Ireland, Galway

February 2014

Supervisor: Prof. Robert J. Woods

## Table of Contents

Abstract.....	iv
List of Figures.....	v
List of Tables.....	vii
List of Abbreviations.....	ix
Acknowledgements.....	xii
<b>Chapter 1: Introduction.....</b>	<b>1</b>
<b>1.1 Carbohydrate-binding Proteins.....</b>	<b>1</b>
<b>1.2 Protein Expression and Purification in <i>Escherichia coli</i>.....</b>	<b>4</b>
1.2.1 Recombinant Protein Expression.....	4
1.2.2 Protein isolation by cell disruption.....	7
1.2.3 Protein Purification.....	8
<b>1.3 Protein Characterisation.....</b>	<b>10</b>
1.3.1 Glycan array screening.....	10
1.3.2 ELISA.....	11
1.3.3 Surface Plasmon Resonance (SPR).....	16
<b>1.4 Aims of Thesis.....</b>	<b>18</b>
<b>Chapter 2: Materials &amp; Methods.....</b>	<b>39</b>
<b>2.1 Acknowledgements.....</b>	<b>39</b>
<b>2.2 Materials.....</b>	<b>39</b>
<b>2.3 Methods.....</b>	<b>44</b>
2.3.1 Synthesis of C3.1 scFv and $\alpha$ -L-Fucosidase Genes.....	44
2.3.2 Preparation of chemically competent cells.....	44
2.3.3 Transformation of plasmid DNA into <i>E.coli</i> cells.....	44
2.3.4 Overnight cultures and glycerol stock.....	45
2.3.5 Isolation of plasmid DNA.....	45
2.3.6 Cloning of Genes into the expression vectors.....	45
2.2.7 Sequencing analysis.....	45
2.3.8 Generation of B6.1 and B6.1 mut S100R scFvs via Site-Directed Mutagenesis (SDM).....	46
2.3.9 Generation of $\alpha$ -L-Fucosidase inactive mutants.....	49
2.3.10 Polymerase Chain Reaction (PCR).....	51
2.3.11 Protein expression protocol.....	52
2.3.12 Protein isolation.....	52
2.3.13 Immobilised Metal Affinity Chromatography (IMAC).....	52
2.3.14 Sodium-dodecyl-sulphate Polyacrylamide Gel Electrophoresis (SDS-PAGE).....	53
2.3.15 Western Blot.....	54
2.3.16 Size Exclusion Chromatography (SEC).....	55
2.3.17 Factor Xa Cleavage of D224N-5His from MBP.....	55
2.3.18 Extraction of <i>Candida albicans</i> cell wall components.....	56
2.3.19 Enzyme-linked Immunosorbent Assay (ELISA) for the scFvs.....	57
2.3.20 Enzyme-linked Immunosorbent Assay for $\alpha$ -L-Fucosidase	

<i>Indirect ELISA</i> .....	58
2.3.21 <i>Surface Plasmon Resonance (SPR) studies of the B6.1 scFvs</i> ....	60
2.3.22 <i>Surface Plasmon Resonance (SPR) of D224N-5His</i> .....	60
<b>Chapter 3: Single-chain variable fragment antibodies for <i>Candida</i></b>	
<i>albicans</i> glycans.....	63
<b>3.1 Introduction</b> .....	63
<b>3.2 Results and Discussion</b> .....	68
3.2.1 <i>Cloning and expression of the C3.1 single-chain variable</i> <i>Fragment</i> .....	68
3.2.2 <i>Generation of B6,1 scFvs</i> .....	68
3.2.3 <i>Expression of the C3.1, B6.1 and S100R single-chain variable</i> <i>fragment</i> .....	72
3.2.4 <i>Enzyme linked immunosorbent assay (ELISA)</i> .....	81
3.2.5 <i>Surface plasmon resonance studies</i> .....	82
<b>3.3 Conclusions and Future Work</b> .....	90
3.3.1 <i>Conclusions</i> .....	90
3.3.2 <i>Future Work</i> .....	91
<b>Chapter 4: Development of Fucosidase as a specific binding protein for</b> <b>fucose</b> .....	112
<b>4.1 Introduction</b> .....	112
4.1.1 <i>Glycosylation</i> .....	112
4.1.2 <i>Lewis antigen biosynthesis</i> .....	114
4.1.3 <i>Inactive Enzymes as Substrate-Affinity reagents</i> .....	116
4.1.4 <i><math>\alpha</math>-L-Fucosidase</i> .....	116
<b>4.2 Results and Discussion</b> .....	118
4.2.1 <i>Cloning into the pIT2 plasmid vector</i> .....	118
4.2.2 <i>Generation of the D224A and D224N mutants</i> .....	121
4.2.3 <i>Expression of the D224A/D224N mutants</i> .....	122
4.2.4 <i>Cloning into the pMAL-c5x expression vector</i> .....	126
4.2.5 <i>Expression of the D224N-MBP fusion protein</i> .....	130
4.2.6 <i>Cleavage of D224N-5His-MBP with Factor Xa</i> .....	136
4.2.7 <i>Glycan array screening</i> .....	138
4.2.8 <i>Enzyme linked immunosorbent assay (ELISA)</i> .....	140
4.2.9 <i>Surface plasmon resonance studies</i> .....	143
<b>4.3: Conclusions and Future Work</b> .....	145
4.3.1 <i>Conclusions</i> .....	145
4.3.2 <i>Future Work</i> .....	147
<b>Chapter 5: General Conclusions</b> .....	155
<b>Appendix I</b> .....	162
<b>Appendix II</b> .....	164

## Abstract

Glycans play important roles in many biological interactions. They are involved in cell-cell interactions, function as a point of entry for viral infections and facilitate the adhesion of microbes in the body. Glycans of interest may be normally present on cell surfaces or may be the result of a change in the normal glycosylation leading to different disease states. As a result these glycans make interesting targets for the development of diagnostic reagents. Antibodies, lectins and enzymes are three types of carbohydrate-binding proteins that recognise these cell surface glycans. We are interested in two different carbohydrate-binding protein systems. Firstly, single chain variable fragment antibodies based on murine monoclonal antibodies (mAbs), C3.1 (IgG3) and B6.1 (IgM), that are both specific for the same  $\beta$ -1-2-mannotriose cell-wall epitope on *Candida albicans* and secondly an inactive  $\alpha$ -L-fucosidase enzyme for the recognition of terminal fucose residues.

We engineered a recombinant single-chain variable fragment (scFv) Ab consisting of the variable heavy and light chains of the parent C3.1 IgG3 mAbs. Using site-directed mutagenesis (SDM) we generated B6.1 subclones that comprise the six unique amino acid point mutations between the two antibodies, the B6.1 scFv and a B6.1 mutant subclone. We report on the expression, purification and kinetic analysis of the C3.1 and B6.1 scFvs to date.

An  $\alpha$ -L-fucosidase was engineered based on  $\alpha$ -L-fucosidase from *Thermotoga maritima* that is the closest bacterial relative of mammalian  $\alpha$ -L-fucosidases and shares 38% identity with human  $\alpha$ -L-fucosidase. The nucleophilic activity of the enzyme was removed by SDM to introduce a point mutation D224N. We are interested in determining the affinity and specificity of the D224N  $\alpha$ -L-fucosidase by glycan array screening and SPR.

## List of Figures:

- Figure 1.1:** General structure of an immunoglobulin
- Figure 1.2:** Direct ELISA for the detection of antigens
- Figure 1.3:** Indirect ELISA for the detection of antigens
- Figure 1.4:** Direct sandwich ELISA for the detection of antigens
- Figure 1.5:** Direct competitive ELISA for the detection of antigens
- Figure 3.1:** Phosphomannoprotein of the *Candida albicans* cell wall
- Figure 3.2:** General structure of (A) an immunoglobulin, (B) fragment antigen binding, (C) fragment variable, (D) disulfide stabilized Fv, (E) single chain variable fragment
- Figure 3.3:** Sequence alignment of the C3.1 and B6.1 scFvs, showing the FWRs, CDRs and six amino acid mutations.
- Figure 3.4:** General structure of a scFv fragment
- Figure 3.5:** pIT2 vector plasmid map
- Figure 3.6:** Sequence alignment of C3.1 and S100R scFvs
- Figure 3.7:** Sequence alignment of C3.1 and B6.1 scFvs
- Figure 3.8:** Purification of the C3.1 scFv using IMAC chromatography and analysis by SDS-PAGE and Western blot
- Figure 3.9:** Purification of the C3.1 scFv using SEC chromatography and analysis by SDS-PAGE and Western blot
- Figure 3.10:** Purification of the S100R scFv using IMAC chromatography and analysis by SDS-PAGE and Western blot
- Figure 3.11:** Purification of the B6.1 scFv using IMAC chromatography and analysis by SDS-PAGE and Western blot
- Figure 3.12:** Purification of the S100R scFv using SEC chromatography and analysis by SDS-PAGE and Western blot
- Figure 3.13:** Purification of the B6.1 scFv using SEC chromatography and analysis by SDS-PAGE and Western blot
- Figure 3.14:** Binding of the C3.1, S100R and B6.1 scFvs to the *Candida albicans* cell-wall epitope.
- Figure 3.15:**  $\beta$ -1,2-linked mannosides; (1) disaccharide, (2) trisaccharide and (3) tetrasaccharide.

**Figure 3.16:** Surface plasmon resonance of S100R scFv binding to disaccharide

**Figure 3.17:** Surface plasmon resonance of S100R scFv binding to trisaccharide

**Figure 3.18:** Surface plasmon resonance of S100R scFv binding to tetrasaccharide

**Figure 3.19:** Surface plasmon resonance of B6.1 scFv binding to trisaccharide

**Figure 3.20:** Sequence alignment of the C3.1, S100R and B6.1 scFvs

**Figure 4.1:** Biosynthesis of glycans in normal and breast cancer cells.

**Figure 4.2:** Biosynthesis of Lewis antigens: Lewis A (Le<sup>a</sup>), Sialyl Lewis A (sLe<sup>a</sup>), Lewis X (Le<sup>x</sup>) and sialyl Lewis x (sLe<sup>x</sup>).

**Figure 4.3:**  $\alpha$ -L-Fucosidase cloned into the pMK vector from GeneArt<sup>®</sup>

**Figure 4.4:** DNA electrophoresis of (a) a 1% agarose gel showing undigested, linearized and double digested C3.1 pIT2 vector (4.6 kb), and (b) a 2% agarose gel showing undigested, linearized and double digested  $\alpha$ -L-Fucosidase

**Figure 4.5:** Sequence alignment of *Thermotoga maritima*  $\alpha$ -L-Fucosidase (WT\_ALF) with the synthesized  $\alpha$ -L-Fucosidase (ALF) in the pIT2 vector

**Figure 4.6:** Partial sequence alignment of *Thermotoga maritima*  $\alpha$ -L-Fucosidase (WT\_ALF) with the D224A and D224N  $\alpha$ -L-Fucosidase mutants

**Figure 4.7:** SDS-PAGE and western blot analysis of the D224A mutant expressed at 18 °C and 37 °C

**Figure 4.8:** SDS-PAGE and western blot analysis of the D224N mutant expressed at 18 °C and 37 °C

**Figure 4.9:** Amplification of the D224A/D224N  $\alpha$ -L-Fucosidase with a 5-His or 6His tag and *EcoRI* restriction site

**Figure 4.10:** DNA electrophoresis of a 1% agarose gel showing undigested, linearized and double digested pMAL-c5x vector (5.6kb)

**Figure 4.11:** Purification of the D224N-5His-MBP using IMAC chromatography and analysis by SDS-PAGE and Western blot after two rounds of IMAC

**Figure 4.12:** Purification of the D224N-5His-MBP using IMAC chromatography and analysis by SDS-PAGE and Western blot after a third round of IMAC

**Figure 4.13:** Purification of the D224N-5His-MBP using SEC chromatography and analysis by SDS-PAGE

**Figure 4.14:** Separation of D224N-5His from MBP using IMAC chromatography and analysis by SDS-PAGE

**Figure 4.15:** Graphical representation showing no binding by either (A) D224N-5His  $\alpha$ -L-Fucosidase or (B) D224N-5His-MBP fusion to the glycan array.

**Figure 4.16:** ELISA assay testing binding of D224N-5His to various monosaccharides conjugated to BSA via a C14 linker

**Figure 4.17:** ELISA assay testing binding of D224N-5His to Lewis x and sialyl Lewis x conjugated to BSA via a C3 and C14 linker respectively

**Figure 4.18:** Inhibition ELISA assay of D224N-5His with fucose, Lewis x and sialyl Lewis x

**Figure 4.19:** Surface plasmon resonance of D224N-5His binding to Lewis X

## List of Tables:

- Table 2.1:** Reaction order to generate the B6.1 and B6.1 mut S100R scFvs from C3.1 scFv template DNA
- Table 2.2:** Reaction mixtures for Site-Directed Mutagenesis
- Table 2.3:** Cycling parameters for the generation of the B6.1 scFv
- Table 2.4:** Cycling parameters for the generation of the B6.1 mut S100R scFv
- Table 2.5:** Reaction mixtures for generation of D224A and D224N mutants
- Table 2.6:** Cycling parameters for generation of D224A and D224N mutants
- Table 2.7:** Reaction mixture for generation of D224N with a C-terminal 5-His tag and *EcoRI* restriction site
- Table 2.8:** Cycling parameters for polymerase chain reaction to generate D224N with C-terminal 5-His tag and *EcoRI* restriction site
- Table 2.9:** Composition of SDS-PAGE Stacking and Separating Gels
- Table 3.1:** Theoretical molecular weights of C3.1, B6.1 and S100R scFvs
- Table 3.2:** Comparison of ELISA IC<sub>50</sub> values, and SPR values for the C3.1 scFv, S100R scFv and B6.1 scFv
- Table 4.1:** Theoretical molecular weights of D224A and D224N  $\alpha$ -L-Fucosidase mutants
- Table 4.2:** Theoretical molecular weights of D224N-5His-MBP fusion and the D224N-5His after cleavage from MBP
- Table 4.3:** Inhibition data for D224N-5His  $\alpha$ -L-Fucosidase with inhibitors 1 – 3



## List of Abbreviations

<b>2-ME:</b>	2-Mercaptoethanol
<b>AP:</b>	Alkaline phosphatase
<b>APS:</b>	Ammonium persulfate
<b>Arg:</b>	Arginine
<b>Asn:</b>	Asparagine
<b>BCIP:</b>	5-bromo-4-chloro-3'indolylphosphate-p-toluidine salt
<b>BSA:</b>	Bovine serum albumin
<b><i>C. albicans:</i></b>	<i>Candida albicans</i>
<b>CARB:</b>	Carbenicillin
<b>CDR:</b>	Complementary determining region
<b>CFG:</b>	Consortium for Functional Glycomics
<b>CRD:</b>	Carbohydrate recognition domain
<b>DMSO:</b>	Dimethyl sulfoxide
<b>DNaseI:</b>	Deoxyribonuclease I
<b>ds:</b>	Double stranded DNA
<b>dsFv:</b>	Disulfide stabilized variable fragment
<b>DTT:</b>	Dithiothreitol
<b><i>E.coli:</i></b>	<i>Escherichia coli</i>
<b>EDC:</b>	N-ethyl-N'(3-dimethylaminopropyl) carbodiimide
<b>EDTA:</b>	Ethylenediaminetetraacetic acid
<b>ELISA:</b>	Enzyme-linked immunosorbent assay
<b>Fab:</b>	Fragment antigen binding
<b>Fc:</b>	Fragment crystallisable
<b>Fuc:</b>	Fucose
<b>FucT:</b>	Fucosyltransferase
<b>Fv:</b>	Fragment variable
<b>FWR:</b>	Framework region
<b>Gal:</b>	Galactose
<b>GalNAc:</b>	N-acetylgalactosamine
<b>GlcNAc:</b>	N-acetylglucosamine
<b>GBP:</b>	Glycan binding protein
<b>Glu:</b>	Glutamic acid
<b>Gly:</b>	Glycine
<b>gor:</b>	Gluthathione reductase

<b>GST:</b>	Glutathione S-transferase
<b>GYEBP:</b>	Glucose, yeast extract, bactopectone
<b>HBSN:</b>	HEPES-buffered saline
<b>HCl:</b>	Hydrochloric acid
<b>HEPES:</b>	N-(2-Hydroxyethyl)piperazine-N'-2-ethanesulfonic acid
<b>His:</b>	Histidine tag
<b><i>H. pylori:</i></b>	<i>Helicobacter pylori</i>
<b>HRP:</b>	Horseradish peroxidase
<b>H<sub>2</sub>SO<sub>4</sub>:</b>	Sulfuric acid
<b>Ig:</b>	Immunoglobulin
<b>Ile:</b>	Isoleucine
<b>IMAC:</b>	Immobilised Metal Affinity Chromatography
<b>IPTG:</b>	Isopropyl β-D-1-thiogalactopyranoside
<b>Kan:</b>	Kanamycin
<b>K<sub>D</sub>:</b>	Dissociation constant
<b>LB:</b>	Luria broth
<b>Le<sup>a</sup>:</b>	Lewis a antigen
<b>Le<sup>b</sup>:</b>	Lewis b antigen
<b>Le<sup>x</sup>:</b>	Lewis x antigen
<b>Le<sup>y</sup>:</b>	Lewis y antigen
<b>mAb:</b>	Monoclonal antibody
<b>MBP:</b>	Maltose binding protein
<b>NaCl:</b>	Sodium chloride
<b>NaOH:</b>	Sodium hydroxide
<b>NBT:</b>	Nitro-blue tetrazolium chloride
<b>Neu5Ac:</b>	N-acetylneuraminic acid
<b>NHS:</b>	N-hydroxysuccinimide
<b>NTA:</b>	Nitrilotriacetic acid
<b><i>ori:</i></b>	Origin of replication
<b>PBS:</b>	Phosphate buffered saline
<b>PBST:</b>	Phosphate buffered saline, tween 20
<b>PCR:</b>	Polymerase chain reaction
<b>PEG:</b>	Polyethylene glycol 8000
<b>PMSF:</b>	Phenylmethylsulfonyl fluoride
<b>PNPP:</b>	p-Nitrophenyl phosphate

<b>PVDF:</b>	Polyvinylidene difluoride
<b>R.T:</b>	Room temperature
<b>RU:</b>	Response units
<b>SB:</b>	Superbroth
<b>scFv:</b>	Single chain variable fragment
<b>SDS:</b>	Sodium dodecyl sulphate
<b>SDS-PAGE:</b>	Sodium dodecyl sulphate polyacrylamide gel electrophoresis
<b>SDM:</b>	Site-directed mutagenesis
<b>SEC:</b>	Size Exclusion Chromatography
<b>Ser:</b>	Serine
<b>sLe<sup>a</sup>:</b>	Sialyl Lewis a antigen
<b>sLe<sup>s</sup>:</b>	Sialyl Lewis x antigen
<b>ST:</b>	Sialyltransferase
<b>sTF:</b>	Sialyl Thomsen-Friedenreich antigen
<b>sTn:</b>	Sialyl Thomsen-nouvelle antigen
<b>SPR:</b>	Surface plasmon resonance
<b>ss:</b>	Single stranded DNA
<b>TAE:</b>	Tris-acetate-EDTA
<b>TB:</b>	Terrific broth
<b>TEMED:</b>	N,N,N',N'-tetramethylethylenediamine
<b>TF:</b>	Thomsen-Friedenreich antigen
<b>Thr:</b>	Threonine
<b><i>T. maritima:</i></b>	<i>Thermotoga maritima</i>
<b>TMB:</b>	3,3',5,5'-tetramethylbenzidine
<b>Tn:</b>	Thomsen-nouvelle antigen
<b>Tris Base:</b>	Tris(hydroxymethyl) aminomethane base
<b>Tris-HCl:</b>	Tris hydrochloride
<b><i>trxB:</i></b>	Thioredoxin reductase
<b>TSS:</b>	Transformation storage solution
<b>V<sub>H</sub>:</b>	Variable heavy chain
<b>V<sub>L</sub>:</b>	Variable light chain

## Acknowledgements

I would like to thank my supervisor Prof. Rob Woods for the opportunity to pursue a PhD in his research group. I would also like to acknowledge the School of Chemistry, Science Foundation of Ireland, and the European Development Fund.

Thanks to Dr. Elisa Fadda, Dr. Lori Yang for proofreading some of my thesis and thanks to Dr. Nina Weisser and Dr. Stephen Cunningham, for assistance in SPR experiments.

I would like to thank Nina and Elisa for their enthusiasm and guidance throughout the last four and a half years. Your help and support has been wonderful during the course of this work. Joanne, Oliver, Jen, Hannah and Niall, it has been a pleasure to work alongside you all for the last few years. I'm sure everyone will miss the lunch time conversations in the coming years.

To everyone in the Georgia Woods group, thank you for making me welcome while I was there. To Lori and Anita, who helped me out so much at the beginning and also to Ken and Megan, for taking an Irish girl under their wing and becoming my adoptive family while I was in Georgia.

To all my wonderful friends, Michelle and Ronan, who have been here with me since the very first day of our undergraduate, and also my fantastic friends in the School of Chemistry, Christine, Eoin and Noel. From tea breaks to chemistry nights out, which were often needed, all of your friendship has been so important.

A special thank you goes to Ted. You have been such an amazing friend, and always have a kind, encouraging and often calming word when needed most. Your support and enthusiasm in everything in the last two years has meant the world.

Finally to my parents, John and Carmel, and my sister Jacqueline, I owe the most thanks. I am extremely lucky to have such a wonderful family who has shown nothing but constant love, support, encouragement and belief in me. Thanks for everything that you have done to help me during the course of my PhD, because without you, I would truly be lost.

## Chapter 1: Introduction

### 1.1 Carbohydrate-binding Proteins

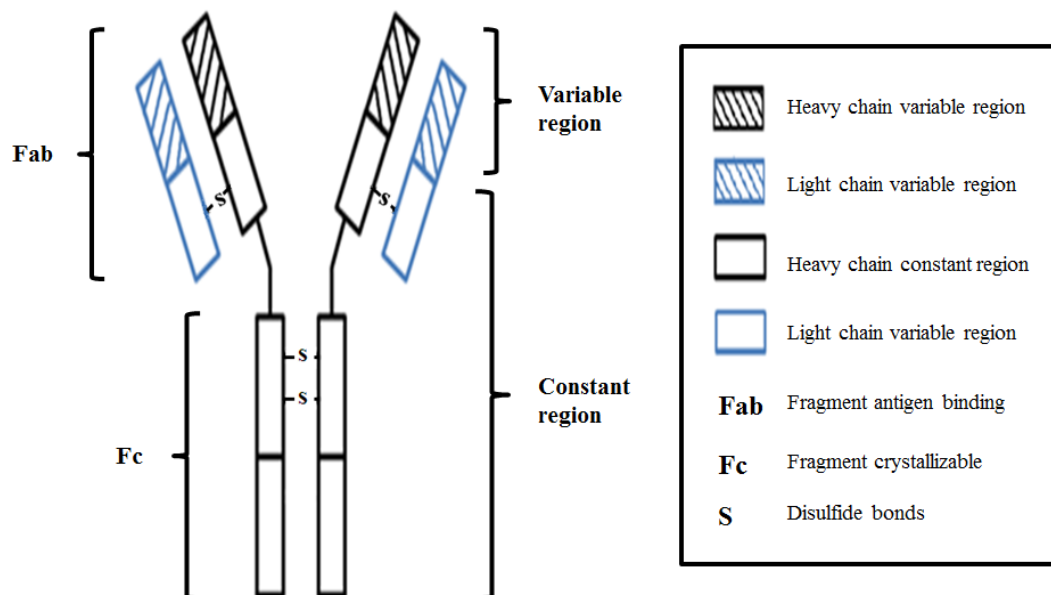
Glycans play an important part in biological functions from cell-cell interactions (Varki 1994), ligands for viral entry and infection (Wang et al. 2009), as well as cell-microbe interactions (Hooper & Gordon 2001). Recognition of glycans is carried out by carbohydrate-binding proteins including: lectins, antibodies and enzymes.

Lectins are a class of glycan binding proteins that were originally discovered in plants, but are now known to be also present in animals, bacteria and viruses (Varki et al. 2009; Sharon & Lis 2004; Sharon 2008). They act as glycan-recognition molecules and have multiple functions as summarized by Sharon and Lis (Sharon & Lis 2004). For example, viral and bacterial lectins are involved in infections of hosts, plant lectins may protect plants from pathogenic microorganisms, and animal lectins are involved in leukocyte trafficking. Highly conserved carbohydrate recognition domains (CRDs) have been identified allowing for the classification of lectins into structurally related families and superfamilies (Sharon & Lis 2004; Ghazarian et al. 2011). Drickamer first described the CRDs of the C-type lectins and the S-type lectins, now known as the galectins (Drickamer 1988). There are a number of other families of lectins including: the R-type lectins (R. D. Cummings & Etzler 2009), L-type lectins (Etzler et al. 2009), P-type lectins (Dahms 2002) and I-type lectins (Angata 2002). The most abundant animal lectins are the C-type lectins, which are calcium-dependent glycan binding proteins. Of these, the selectins are a well-characterized family whose roles in cell-cell interactions include the trafficking of lymphocytes during an inflammation response (Magnani 2004), as well as leukocyte adhesion and rolling on the endothelium (Gout et al. 2008) by recognition of cell-surface glycans. Binding affinities for lectins are relatively weak (Weis & Drickamer 1996); however multivalent interactions can result in increased avidity (Varki et al. 2009; Ghazarian et al. 2011; Dam et al. 2005). Lectins are often broadly selective for classes of glycans, but can be relatively specific for certain glycans (Weis & Drickamer 1996).

Immunoglobulins can be divided into five classes: IgA, IgD, IgE, IgG and IgM, and within these the IgA has two subclasses (IgA1, IgA2) and the IgG four subclasses

(IgG1, IgG2, IgG3 IgG4) (Weisser & Hall 2009; Salfeld 2007). Approximately 80% of immunoglobulins in humans are IgGs (Madigan, Michael T; Martinko 2005).

Immunoglobulins are “Y”-shaped structures consisting of two identical heavy chains and two identical light chains as shown in Figure 1.1.



**Figure 1.1:** General structure of an immunoglobulin (Ig) showing the fragment antigen binding, fragment crystallisable, variable regions, constant regions, heavy chains, light chains and disulphide bonds.

There are five heavy chain constant domains: alpha ( $\alpha$ ), delta ( $\delta$ ), epsilon ( $\epsilon$ ), gamma ( $\gamma$ ) and mu ( $\mu$ ) which determine the class of immunoglobulins, and two light chain constant domains, kappa ( $\kappa$ ) and lambda ( $\lambda$ ) (Weisser & Hall 2009). Each heavy and light chain contains constant domains and one variable domain. The variable domains are located on the N-termini of the heavy and light chain and are responsible for the specificity and affinity of the immunoglobulins (Weisser & Hall 2009; Maynard & Georgiou 2000). Both the heavy and light chain variable regions contain framework regions and complementary determining regions (CDRs). The CDRs on the surface recognise and bind antigens (Maynard & Georgiou 2000). Antibodies are generated in hosts in defence against pathogens, and their specificities and affinities are now utilised as reagents for sample analyses and therapeutics

(Weisser & Hall 2009; Maynard & Georgiou 2000). Anti-glycan antibodies can be used in many applications from ELISA assays, blood-typing, histochemical staining, and affinity purification (Richard D Cummings & Etzler 2009). They also have uses as therapeutics with some already on the market or in clinical trials (Salfeld 2007; Maynard & Georgiou 2000).

Enzymes are biomolecules, usually proteins that are responsible for the catalysis of specific reactions. The two main classes of carbohydrate-acting enzymes are the glycoside hydrolases and the Glycosyltransferases (Henrissat & Davies 2000). Glycosyltransferases are involved in the biosynthesis of glycans (Rini et al. 2009) while the glycoside hydrolases are responsible for the hydrolysis of glycosidic bonds (Davies & Henrissat 1995). Both the glycoside hydrolases (Henrissat 1991) and Glycosyltransferases (Coutinho et al. 2003) have been classified into families dependent on their structural and mechanistic features. Glycoside hydrolases are responsible for the metabolism of glycoproteins, which allows for these substrates to be utilized by the cell. A deficiency in any hydrolase can result in lysosome storage diseases (Neufeld 1991). In these diseases, the incompletely degraded substrates will accumulate in the lysosome (Michalski & Klein 1999; Neufeld 1991). An example of a lysosomal storage disease is fucosidosis, which is caused by a defective  $\alpha$ -L-Fucosidase (Michalski & Klein 1999). Mutations in the  $\alpha$ -L-Fucosidase gene have been linked to fucosidosis (Cragg et al. 1997; Willems et al. 1999) and there are two subtypes identified. Type 1 is a severe infantile form and type 2 is a milder form (Michalski & Klein 1999). Some of the clinical features of fucosidosis are progressive mental retardation, growth retardation, neurological deterioration and recurrent infections (Michalski & Klein 1999). For correction of the enzyme deficiency treatment options were bone marrow transplantation which was shown to increase the enzymatic levels (Miano et al. 2001) while future treatments may involve gene therapy (Occhiodoro et al. 1992).

## 1.2 Protein Expression and Purification in *Escherichia coli*

### 1.2.1 Recombinant Protein Expression

Recombinant protein expression can be carried out in a number of different host systems, including bacteria (Chen 2012; Berlec & Štrukelj 2013), yeast (Berlec & Štrukelj 2013; Celik & Calik 2012), mammalian cells (Berlec & Štrukelj 2013; Zhu 2012) and insect cells (Drugmand et al. 2012). Each system has advantages and disadvantages as reviewed in Yin *et al.* (Yin et al. 2007) and the production of protein in bacterial cells (*E. coli*) will be the focus here. *E. coli* was the first microorganism used for protein production (Altenbuchner, J.; Mattes 2006) and is widely used in research due to being relatively inexpensive to culture.

There are several different strains of *E. coli* commercially available for protein production. Of these the *E. coli* BL21 strain and its derivatives are the most commonly used. Protease deficient strains of BL21 are deficient in *ompT* and *lon* proteases. The *ompT* protease cleaves the T7 RNA polymerase (Grodberg & Dunn 1988) and *lon* protease degrades misfolded and recombinant proteins (Phillips et al. 1984; Gottesman 1990; Gottesman 1989). Differences in codon frequency between the target gene and the host can be overcome by the use of codon-supplemented strains such as BL21-RP, BL21-RIL, BL21-RIPL and Rosetta (Francis & Page 2001; Gopal & Kumar 2013). It has been shown that supplying the rare codons during expression yielded similar results to a synthetic codon optimized gene (Burgess-Brown et al. 2008). Strains with mutations in the thioredoxin reductase (*trxB*) or glutathione reductase (*gor*) genes such as BL21 *trxB* or Origami, help maintain the reducing environment in the cytoplasm allowing for the formation of disulphide bonds (Francis & Page 2001; Gopal & Kumar 2013; Prinz et al. 1997).

Expression vectors introduced into bacteria for protein expression contain an origin of replication (*ori*), an antibiotic resistance marker and an expression cassette containing the target gene. Replication of the vector is initiated at the origin of replication and this also determines the copy number of expression plasmids (Francis & Page 2001; Altenbuchner, J.; Mattes 2006). High copy number plasmids are generally preferred for protein expression (Francis & Page 2001). Antibiotic resistant genes are present in plasmids and function as selection markers (Madigan 2005). The



synthesis of target genes is under the control of promoters and the most widely used are the T7 RNA promoter, the *araBAD* promoter, *trc* and *tac* promoter and the *cspA* promoter (Francis & Page 2001). The most common promoter system used in *E. coli* is the T7 RNA promoter system. Expression driven by the T7 RNA polymerase is five times faster than that of the bacterial RNA polymerase (William Studier et al. 1990). The T7 polymerase itself is under the control of the *lacUV5* promoter and will not be produced until induction. Following induction by IPTG, the T7 RNA polymerase is produced and can subsequently begin expression of the target gene (William Studier et al. 1990). The arabinose promoter system (*araBAD*) is induced by L-arabinose and it has low basal activity in comparison to the T7 promoter system, making it suitable for the expression of toxic proteins (Lee et al. 1987). Hybrid promoters *trc* and *tac*, differ only by the spacing between the -35 and -10 consensus sequence (Brosius et al. 1985). These promoters are hybrids of the *trp* promoter and *lacUV5* promoter (Francis & Page 2001; de Boer et al. 1983) and induction of expression is controlled by the addition of IPTG (Brosius et al. 1985). For expression of proteins at low temperature the *cspA* promoter can be utilised. There is no chemical induction of this promoter just a reduction of temperature (Vasina & Baneyx 1996). Expression can be carried out at reduced temperatures under control of the *cspA* promoter and this can be beneficial for aggregation prone proteins (Vasina & Baneyx 1997).

Expression conditions have an important role in the successful protein production. Conditions that can be altered for the production of protein include the expression temperature, induced concentration and growth medium. Protein solubility is an issue in protein expression and a reduction in expression temperature from 37 °C to 15 °C has been found to improve soluble expression (Shirano & Shibata 1990). Lowered expression temperatures can also lead to a reduction in protein aggregation (Vasina & Baneyx 1997). The reduction in IPTG concentration has also lead to an increase in soluble protein production (Turner et al. 2005). Growth media is a source of nutrients for cells, and some of the commonly used media include Luria broth (LB), Terrific broth (TB) and Super Broth (SB) (Francis & Page 2001; Sahdev et al. 2008). Modification of the composition of some of these media has resulted in increased protein solubility and yield (Sahdev et al. 2008; Yang et al. 2003).

Protein expression in *E. coli* takes place in the cytoplasm (Sørensen & Mortensen 2005), but can also be directed to the periplasm or outer membrane under the control of signal sequences (Choi & Lee 2004). Signal sequences are short amino acid sequences that direct transport of proteins outside of the cytoplasm. In principle, the signal sequence is cleaved during transport of the protein out of the cytoplasm. A number of signal sequences have been used for utilization for secretion of proteins from the cytoplasm (Choi & Lee 2004) including PelB (Lei et al. 1987), OmpA (Movva et al. 1980) and PhoA. Secretion of proteins to the culture supernatant can also take place. This may be due to leakage of the protein due to increased permeability of the cell membrane (Choi & Lee 2004). Small proteins have been shown to be secreted into the culture medium (Tong et al. 2000). There are also some methods for the extracellular secretion of proteins. The outer membrane protein F (OmpF) was found to be excreted into the culture medium and was then used as a fusion partner to Human  $\beta$ -Endorphin for extracellular secretion of the recombinant protein (Jeong & Lee 2002). Secretion of a  $\alpha$ -hemolysin fusion with synthetic human interleukin-6, was carried out using the  $\alpha$ -hemolysin signal sequence for extracellular expression of protein (Li et al. 2002).

Tagging of proteins for expression is routinely carried out as a method for affinity purification or to improve solubility (Malhotra 2009). Some examples of affinity tags for purification include the His-tag (Hoffmann & Roeder 1991; Lichty et al. 2005) and FLAG-tag (Einhauer & Jungbauer 2001; Lichty et al. 2005). The His-tag is a widely used tag for purification by IMAC, which is based on the affinity of the tag for divalent ions such as nickel or cobalt (Porath et al. 1975). The 8 amino acid FLAG-tag is used in purification by utilizing its affinity for different antibody resins (Einhauer & Jungbauer 2001). Insoluble protein production can be improved by the expression of proteins with solubility enhancing tags such as MBP and GST (Malhotra 2009). These tags also function as affinity tags, with the MBP-tag purified using an amylose resin, and the GST-tag purified using glutathione resin. In some applications it is necessary to remove the tags; this is accomplished using proteases that recognise specific sequences. Examples of proteases are enterokinase, factor Xa and Thrombin (Malhotra 2009).

### 1.2.2 Protein isolation by cell disruption

Recombinant protein can be produced in large quantities in *E. coli* and there are different methods available for the release of these proteins from the periplasm and cytoplasm of cells. There are three main methods for the release of proteins: enzymatic, chemical and physical.

Lysis of cells enzymatically is usually carried out using lysozyme. This enzyme is capable of hydrolysing  $\beta$ -1,4-glycosidic bonds in the bacterial cell walls (Scawen & Hammond 2000). Gram-positive bacterial are more susceptible to lysis in this method but the final lysis also involves the suspension buffer. Gram-negative cells cannot be lysed by lysozyme alone and require the presence of EDTA to chelate any metal ions to allow for lysis (Scawen & Hammond 2000). Ionic strength has been shown to have an effect of lysozyme, with increased ionic strength resulting in higher enzyme performance while the rate of cell lysis decreased. The optimal conditions for the lysis of *E. coli* were found to be at pH 8.6 with 30 mM NaCl (Sedov et al. 2011).

Detergents are one option for the chemical lysis of cells. They are either ionic, such as sodium lauryl sulphate or non-ionic, such as Triton X-100 (Scawen & Hammond 2000). Detergents are normally used in combination with lysozyme for cell lysis. Some ionic detergents such as sodium dodecyl sulphate can lead to denaturation of proteins (Seddon et al. 2004). For further purification steps detergents must often be removed as they can cause salt precipitation (Scawen & Hammond 2000).

There are a number of different methods for the physical lysis of cells including: osmotic shock, freeze-thaw cell lysis, sonication and high pressure using a French press. Osmotic shock is used for the release of proteins from the periplasm of gram-negative cells (Scawen & Hammond 2000). A buffered 20% sucrose solution is used for re-suspension of the cells which may also be supplemented with EDTA (Chen 2004; Gunnarsen et al. 2010), lysozyme (Gunnarsen et al. 2010) or DNase I (Nielsen et al. 2006). Freeze-thaw cell lysis can release proteins from the cytoplasm. Pelleted cells are frozen in dry ice/ethanol baths for 10minutes, followed by thawing in an ice-water bath for 15 – 20 minutes. This is repeated three times followed by re-suspension of the cells in buffer and incubation in an ice-water bath for 1 hour. To

separate the released proteins from the remaining cells components, the suspension is centrifuged and the supernatant containing the released protein is decanted off for further use. This method often releases protein that is of relatively high purity or in some cases is the only protein released. This method has only been shown to be successful for proteins ranging from 8 – 29 kDa (Johnson & Hecht 1994). A French press lyses cells under high pressure. Cells are suspended in buffer and loaded into the stainless steel cylinder. A piston is pushed against the liquid until the appropriate pressure is reached. The cells are then passed through the exit valve and the change in pressure causes the cells to rupture (Scawen & Hammond 2000; Goldberg 2008). Sonication is a widely used laboratory scale cell disruption technique. This process uses sound waves to lyse cells. Electric current is converted to high frequencies (20,000 Hz) which when a sonicator probe is present in solution results in agitation of the cell suspension. During this vibration bubbles form in the solutions and when they collapse cause the disruption of cells (Goldberg 2008).

### *1.2.3 Protein Purification*

Immobilised Metal Affinity Chromatography (IMAC) utilizes the higher binding affinity of histidine tagged proteins for divalent metal ions such as  $\text{Ni}^{2+}$ ,  $\text{Cu}^{2+}$ ,  $\text{Zn}^{2+}$  and  $\text{Co}^{2+}$ . This method was first shown by Porath et al (Porath et al. 1975) for the purification of proteins with a natural affinity for metal ions. Porath et al (Porath et al. 1975) used the chelating agent iminodiacetic acid to link the metal ions to agarose. Hochuli et al improved the method with the chelating agent nitrilotriacetic acid (NTA) (Hochuli et al. 1987) and the use of oligohistidine tags for the purification of recombinant proteins (Hochuli et al. 1988). Histidine tags up to ten histidine residues in length have been tested (Knecht et al. 2009; Mohanty & Wiener 2004) but tags of six histidine residues are the most common for protein purification. The binding mechanisms of hexa-histidine tags to NTA has been shown by Knecht et al (Knecht et al. 2009). Proteins that are bound to the column can then be eluted in a number of different ways: (1) by a competitive agent such as Imidazole or (2) a low pH buffer (Terpe 2003). This method is used as an initial first round purification to remove many other proteins that are present in the crude protein sample.

Size exclusion chromatography (SEC) or gel filtration chromatography is the separation of molecules on the basis of their molecular sizes. SEC can be used for desalting of samples, fractionation of protein samples or the determination of molecular weight (Hagel & Haneskog 2010). One of the earliest reports of SEC was by Lathe and Ruthven who used starch to separate various substances including saccharides and proteins (Lathe & Ruthven 1956). This method was further developed by Porath and Flodin with the use of cross-linked dextran for the separation of proteins, peptides and amino acids (Porath & Flodin 1959; Porath 1960). A concentrated protein sample is applied to a column 30 – 100 times its volume (Stellwagen 2009). Protein molecules will be separated based on their size, as smaller proteins will enter the pores of the beads and move more slowly through the matrix eluting last, while larger proteins will remain outside the beads and move through the column faster eluting first. SEC is often used as a final purification when the number of other proteins and their molecular weights are significantly different to that of the target protein.

### 1.3 Glycoprotein Characterisation

#### 1.3.1 Glycan array screening

The screening of proteins against glycan microarrays is a high throughput method for determining the binding specificity of glycan binding proteins and there are a number of reviews on their applications (Rillahan & Paulson 2011; Feizi 2003; Feizi & Chai 2004). These include mammalian and bacterial arrays for determining specificity, or more custom libraries such as high mannose or glycosaminoglycan arrays as reviewed in Rillahan and Paulson (Rillahan & Paulson 2011).

Immobilization of glycans onto arrays can be carried out in a number of ways such as; non-covalent immobilisation as used in the immobilization of neoglycolipids (Fukui et al. 2002), thiol chemistry (Kamena et al. 2008), photoimmobilization (Wang et al. 2007) and amine chemistry (Blixt et al. 2004). The Consortium for Functional Glycomics (CFG), funded by the National Institute of General Medical Sciences (<http://www.functionalglycomics.org/>), utilizes amine chemistry (Blixt et al. 2004) for preparation of microarrays, where, amine functionalized glycans are bound to N-hydroxysuccinimide (NHS) activated glass slides. The current version of the array (v5.1) has 610 glycans, consisting of both natural and synthetic glycans. Structures of glycans and their linkers are available on the CFG website. For the analysis of glycan binding proteins (GBPs) on the CFG microarray, the GBPs are dissolved at a known concentration in binding buffer and incubated for an hour at the appropriate temperature. After the washing step, the bound GBPs can be either detected directly or indirectly. For direct detection, the GBPs are labelled with a fluorescent tag such as Alexa Flour 488. Indirect detection requires a fluorescent labelled secondary probe such as cyanine5 labelled streptavidin for the detection of biotinylated GBPs or fluorescent labelled anti-His antibody for the detection of His-tagged GBPs. The relative fluorescent units are measured using a fluorescent reader and the results are reported as an excel file and a histogram (Smith et al. 2010). If the GBPs are analysed at a high concentration, cross-reactivity may be observed, with the GBPs binding to some glycans with a low affinity. To overcome this, the GBPs are analysed at decreasing concentrations to determine the true motifs the GBPs bind to (Smith et al. 2010).

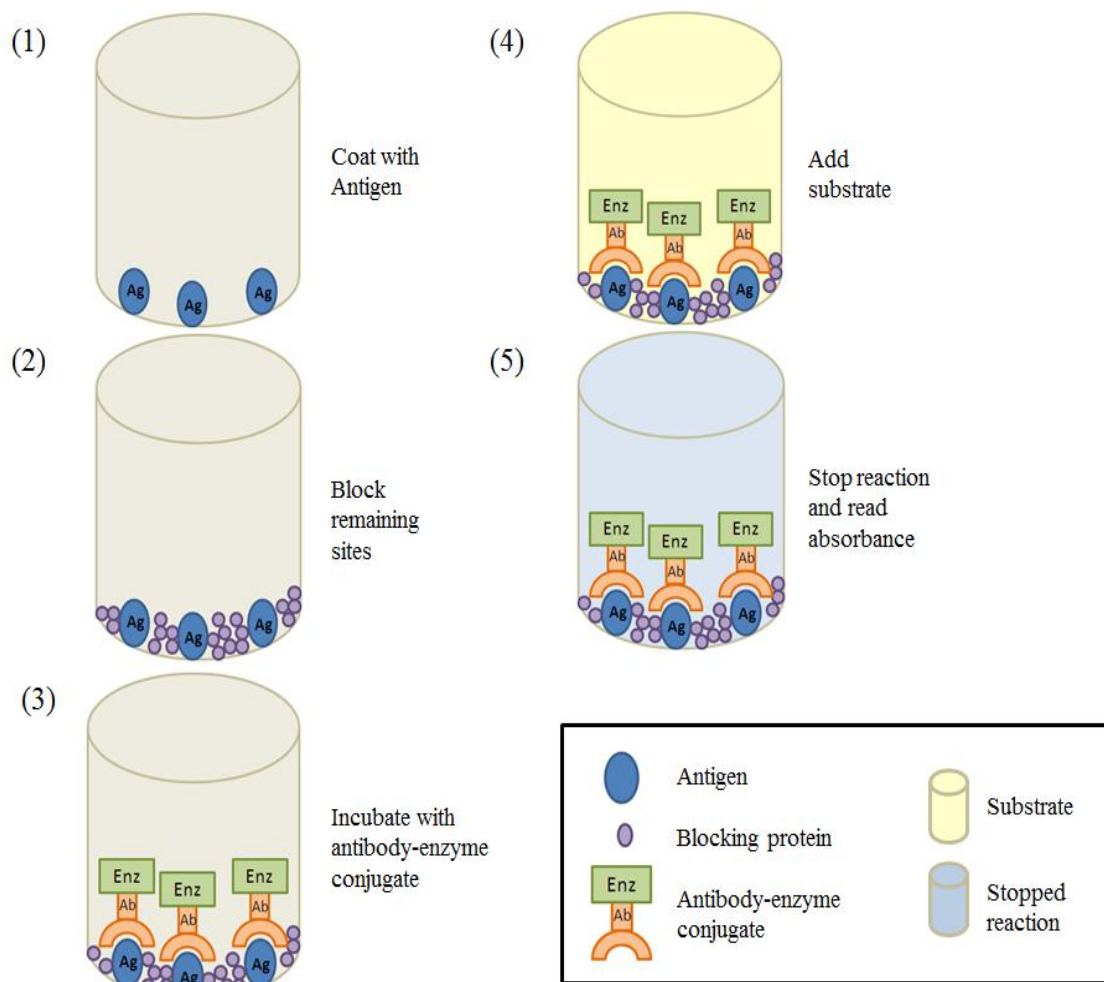
### 1.3.2 ELISA

Enzyme-linked immunosorbent assays (ELISA) can be used to detect the presence of an antigen or a specific protein in a sample and was first described by Engvall and Perlmann (Engvall & Perlmann 1971). In ELISA assays an antigen or antibodies are coated onto the solid surface in ELISA plate wells. The coating times and temperatures are usually 37°C for 1 – 3 hours or overnight at 4°C. Any unbound antigen or antibodies are removed by emptying the wells and washing. The most common buffer used to wash the wells is phosphate buffered saline (PBS) and there may also be added detergents such as Tween-20. To prevent any non-specific interactions between molecules used for the detection of the bound antigen or antibody with any remaining sites in the wells blocking agents are used. Some of the most commonly used blocking agents include bovine serum albumin (Herrmann et al. 1979), human serum albumin (Husby et al. 1985), skim milk powder (Vogt Jr. et al. 1987) or the detergent Tween-20 (Herrmann et al. 1979). To detect the presence of the antigen or antibody enzyme conjugates are used. Horseradish peroxidase and alkaline phosphatase are used with the substrates 3,3',5,5'-Tetramethylbenzidine (TMB) and p-Nitrophenyl Phosphate (PNPP) respectively, which give coloured products (Crowther 2009). The enzyme reactions can be stopped with acids which denature the enzymes and the product can be measured by UV spectrometry. Different enzyme and substrate products are read at different wavelengths depending on the absorption spectrum.

There are four main types of ELISA assays: Direct, Indirect, Sandwich and Competitive which are shown in Figures 1.2 – 1.5.

*Direct ELISA*

Direct ELISAs involves the direct detection of an antigen coated to a plate (Figure 1.2). Any remaining sites on the plate are blocked to prevent non-specific binding. An antibody conjugated with an enzyme such as alkaline phosphatase or horseradish peroxidase is used to detect the antigen or antibody. An appropriate substrate is added and a coloured product will develop. This product is measured using UV spectrometry.

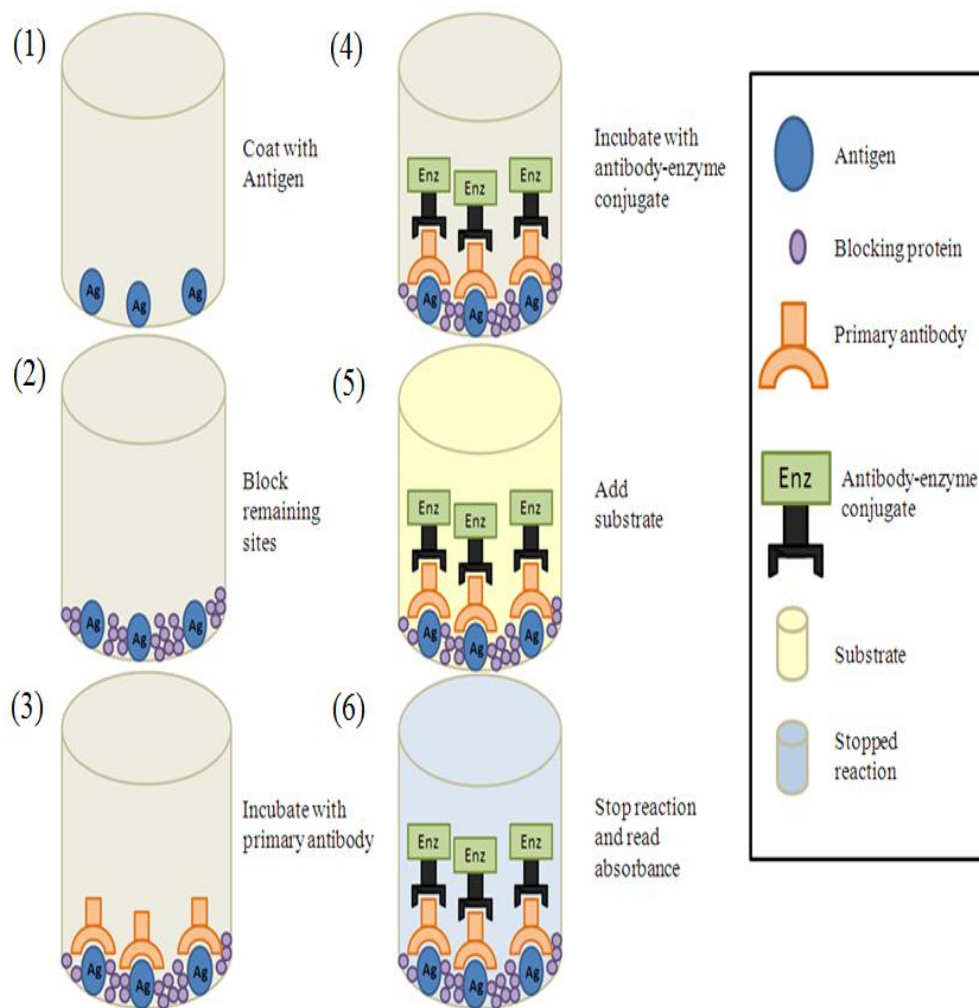


**Figure 1.2:** Direct ELISA for the detection of antigens. (1) Antigen is coated on the plate. (2) Any remaining sites are blocked with suitable protein or detergent. (3) Plate is incubated with antibody-enzyme conjugate. (4) Substrate is added to allow coloured product development. (5) Enzyme reaction is stopped and the UV absorbance read.



*Indirect ELISA*

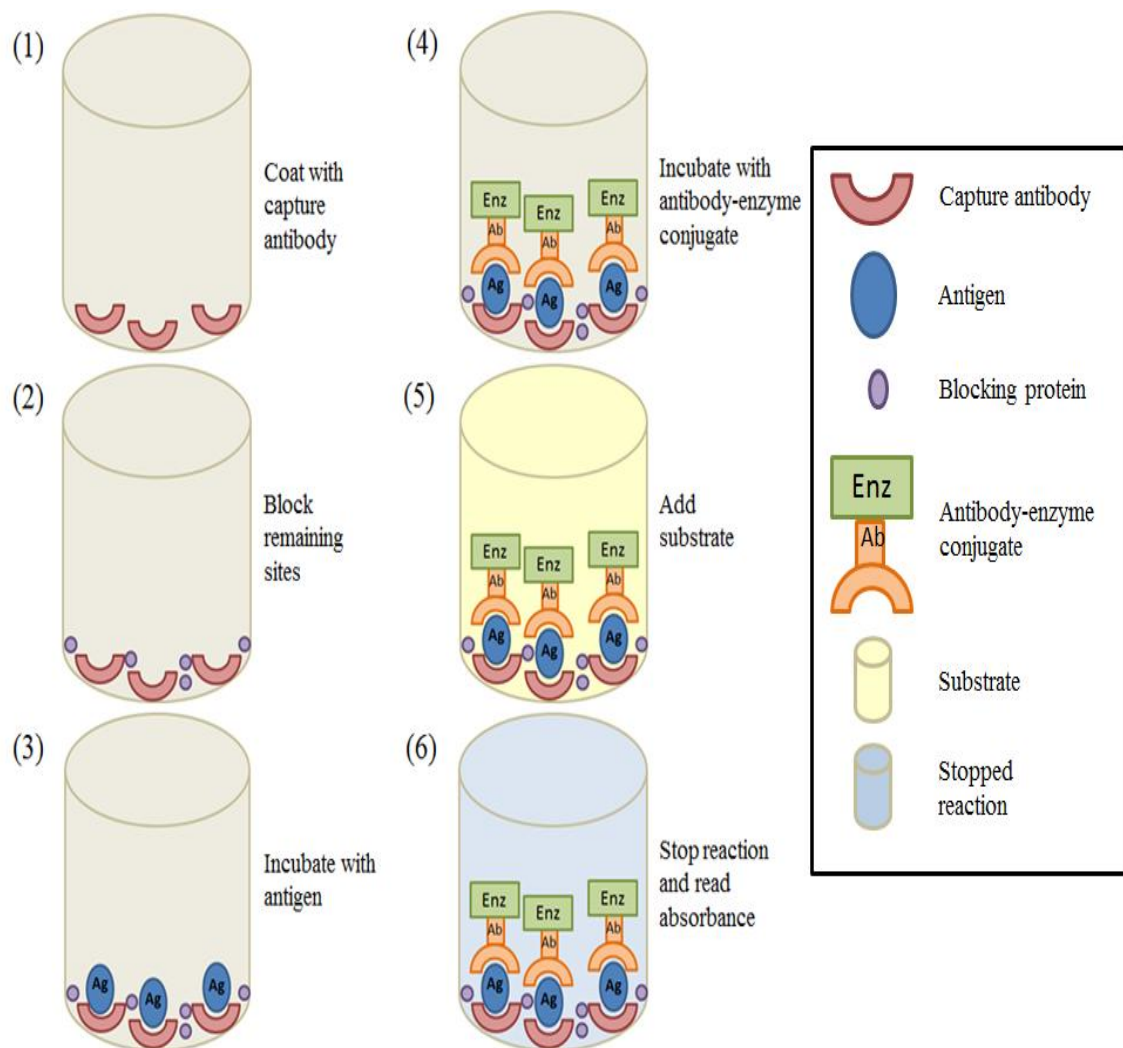
Indirect ELISAs involves detection of an antigen via secondary antibodies (Figure 1.3). Antibodies specific for the antigen coated on the ELISA plate are detected by a secondary antibody enzyme conjugate. Substrate is then added to develop the coloured product which is measured at the appropriate wavelength.



**Figure 1.3:** Indirect ELISA for the detection of antigens. (1) Antigen is coated on the plate. (2) Any remaining sites are blocked with suitable protein or detergent. (3) Plate is incubated with a primary antibody specific for the antigen. (4) Plate is incubated with an antibody-enzyme conjugate. (5) Substrate is added to allow coloured product development. (6) Enzyme reaction is stopped and the UV absorbance read.

*Sandwich ELISA*

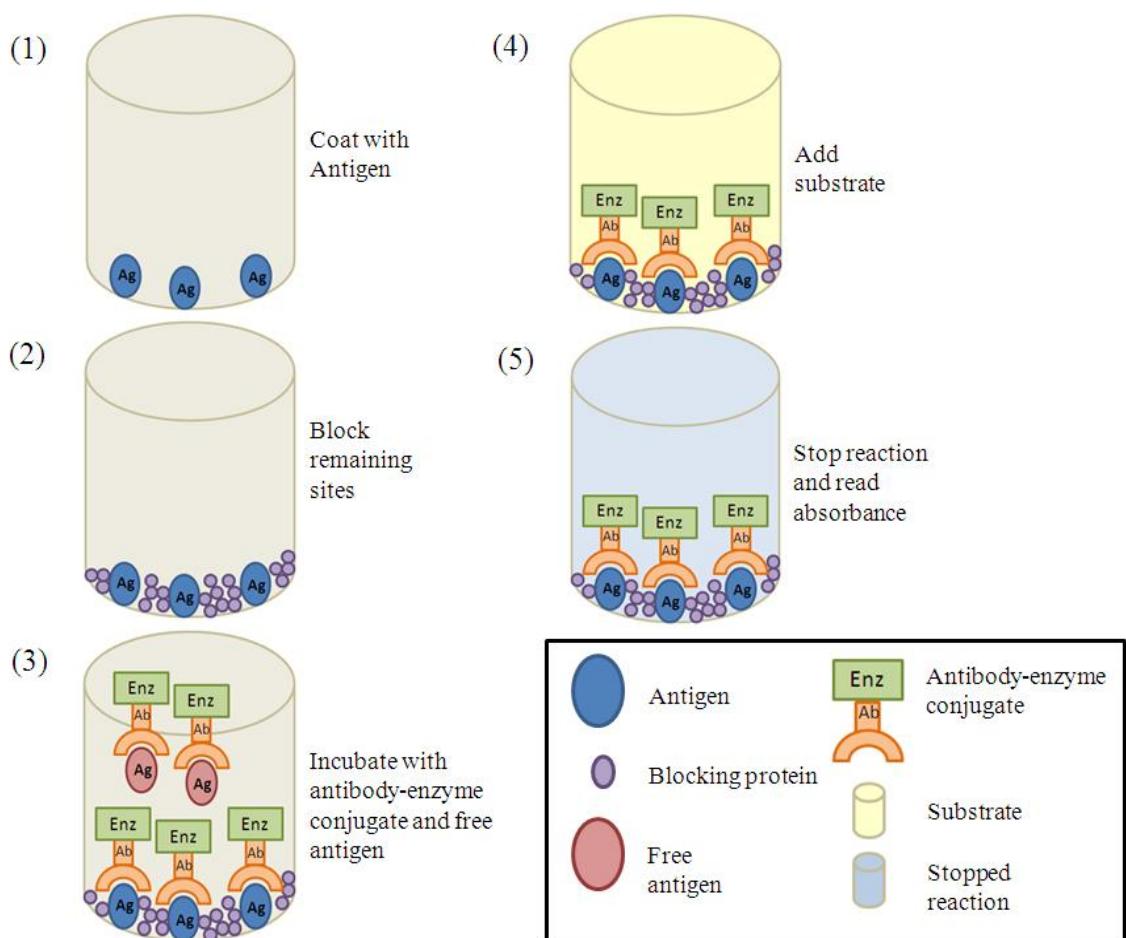
In a sandwich ELISA a capture antibody is first coated on the ELISA plate (Figure 1.4). This is used to bind or capture the antigen of interest. The antigen is then detected either directly or indirectly with a conjugated antibody as described previously.



**Figure 1.4:** Direct sandwich ELISA for the detection of antigens. (1) Capture antibody is coated on the plate. (2) Antigen is incubated on the plate. (3) Any remaining sites are blocked with suitable protein or detergent. (4) Plate is incubated with antibody-enzyme conjugate. (5) Substrate is added to allow coloured product development. (6) Enzyme reaction is stopped and the UV absorbance read.

*Competitive ELISA*

The antigen of interest is coated on the plate. A limited amount of antibody is then incubated with free labelled antigen and added to the plate (Figure 1.5). This is incubated and afterwards any unbound antibody is washed away. Detection of the bound antibody is carried out either directly or indirectly with enzyme conjugates. The amount of antibody that is bound to the plate is inversely proportional to the amount of antigen present in the sample.



**Figure 1.5:** Direct competitive ELISA for the detection of antigens. (1) Antigen is coated on the plate. (2) Any remaining sites are blocked with suitable protein or detergent. (3) Plate is incubated with antibody-enzyme conjugate and free antigen. The free antigen will compete with the bound antigen for the antibody-enzyme conjugate. (4) Substrate is added to allow coloured product development. (5) Enzyme reaction is stopped and the UV absorbance read.

### 1.3.3 Surface Plasmon Resonance (SPR)

Surface plasmon resonance is used to determine affinities and specificities of biomolecules. The first use of SPR for biomolecules was in 1983, which led to the development of this biosensor technology and the launch of the company “BIAcore” in 1990 (Liedberg et al. 1995). SPR is an optical based biosensor and as analyte binds to the ligand, there is a change in the refractive index of the buffer, which will continue until saturation is reached and during dissociation the refractive index will return to the base line (Rich & Myszka 2007; Day 2010). There are a number of different methods for immobilisation of protein/ligand onto the biosensor chip, these include: covalent immobilisation, capturing approaches and hydrophobic attachment (Handbook 2003) and an example of each follows. Amine coupling is a common covalent immobilisation method first described for SPR by Johnsson *et al* (Johnsson et al. 1991). A dextran coated gold chip is first activated with *N*-ethyl-*N*'(3-dimethylaminopropyl) carbodiimide (EDC) and *N*-hydroxysuccinimide (NHS) forming esters. Coupling of protein then takes place in a low pH buffer followed by deactivation of any remaining esters with ethanolamine to form amides (Johnsson et al. 1991). Histidine tagged proteins can be immobilized via capturing approaches. This involves the histidine tagged protein interacting with the nickel nitrilotriacetic acid functionalized chip (Sigal et al. 1996). Lipid monolayer attachment is carried out on a gold chip that is not covered with a dextran matrix unlike most other chips used. The chip is covered with an alkanethiol layer creating a hydrophobic surface. Micelle or liposome preparations are then injected over the chip to allow for adsorption onto the surface. To prevent any multilayer formation, a solution of sodium hydroxide is injected over the chip to remove any loosely bound structures (Cooper et al. 1998). Analyte is injected over the immobilized ligand and as it binds to the ligand there is a change in reflection angle observed as response units. When the rate of binding and dissociation are equal, the system is at equilibrium or in steady state. After the analyte has been passed over the chip and there is return to buffer flow, the dissociation of the analyte will cause a reflective change observed as response units returning to the base line. If some analyte remains on the chip, the surface needs to be regenerated. There are a number of different conditions that can be used to regenerate the surface including; low pH, high pH, high ionic strength or low concentrations of SDS (Handbook 2003). Data fitting to determine association,

dissociation and equilibrium constants is done using the Biacore evaluation software or the BioLogic Software Scrubber.

## 1.4 Aims of thesis

We are interested in studying carbohydrate-binding proteins that include single-chain variable fragment antibodies specific for a  $\beta$ -1,2-mannan epitope and an inactive carbohydrate-processing enzyme specific for fucose.

The monoclonal antibodies C3.1 (IgG3) and B6.1 (IgM) are both specific for the  $\beta$ -1,2-mannan epitope on *Candida albicans* cell surface. These antibodies have a greater affinity for smaller saccharides such as di- and trisaccharides in comparison to larger tetra- to hexasaccharides. This goes against the normal paradigm for antibodies binding to carbohydrates and so is interesting for further study. These antibodies also only differ by six amino acid residues in their variable heavy chain, of which only two residues are present in the antigen binding region of the antibody. The remaining amino acids are part of the scaffold region of the antibody and so are not thought to contribute to binding. We aim to engineer a single-chain variable fragment antibody based on the C3.1 IgG3 variable heavy and light chains and to use this as template DNA to generate the B6.1 scFv via site-directed mutagenesis along with a number of point mutations. Initially the C3.1 and B6.1 scFvs will be expressed and purified. ELISA assays will be used to determine binding of the scFvs to the cell wall epitope and subsequently SPR studies will be carried out to determine the scFvs affinities for different length  $\beta$ -1,2-mannan saccharides.

Lewis antigens and their sialylated equivalents are commonly found in human tissue, however it has been shown that some of these glycans can be overexpressed on cell surfaces in some disease states such as cancer. These glycans can also act as a point of entry leading to infection due to viruses or bacteria. The Lewis antigens therefore make interesting targets for the development of potential diagnostic reagents. The  $\alpha$ -L-Fucosidase enzyme from *Thermotoga maritima* is the closest bacterial fucosidase to mammalian fucosidases and the fucosidases cleave terminal fucose residues. We aim to engineer an  $\alpha$ -L-Fucosidase and make inactive via site-directed mutagenesis. It will then be expressed and purified before characterization of its binding specificity via glycan array screening, ELISA assays and SPR.

## References

- A. Varki; J.B. Lowe, 2009. Biological Roles of Glycans. In A. Varki et al., eds. *Essentials of Glycobiology*. Cold Spring Harbor (NY): Cold Spring Harbor Laboratory Press, pp. 75 – 88. Available at: <http://www.ncbi.nlm.nih.gov/books/NBK1897/>.
- Abd Hamid, U.M. et al., 2008. A strategy to reveal potential glycan markers from serum glycoproteins associated with breast cancer progression. *Glycobiology*, 18(12), pp.1105–1118. Available at: <http://www.ncbi.nlm.nih.gov/pubmed/18818422>.
- Altenbuchner, J.; Mattes, R., 2006. Escherichia coli. In G. Gellissen, ed. *Production of recombinant proteins: novel microbial and eukaryotic expression systems*. Wiley-VCH, pp. 7 – 43. Available at: <https://www.dawsonera.com:443/abstract/9783527604418>.
- Angata, T., 2002. I-type lectins. *Biochimica et Biophysica Acta (BBA) - General Subjects*, 1572(2-3), pp.294–316. Available at: <http://www.sciencedirect.com/science/article/pii/S0304416502003161> [Accessed February 15, 2014].
- Antachopoulos, C., Walsh, T.J. & Roilides, E., 2007. Fungal infections in primary immunodeficiencies. *European Journal of Pediatrics*, 166(11), pp.1099–117. Available at: <http://www.ncbi.nlm.nih.gov/pubmed/17551753>.
- Arnold, J.N. et al., 2011. Novel glycan biomarkers for the detection of lung cancer. *Journal of Proteome Research*, 10(4), pp.1755–1764. Available at: <http://www.ncbi.nlm.nih.gov/pubmed/21214223>.
- Artimo, P. et al., 2012. ExPASy: SIB bioinformatics resource portal. *Nucleic Acids Research*, 40 (W1), pp.W597–W603. Available at: <http://nar.oxfordjournals.org/content/40/W1/W597.abstract>.
- Ashida, H. et al., 2009. Two distinct alpha-L-fucosidases from Bifidobacterium bifidum are essential for the utilization of fucosylated milk oligosaccharides and glycoconjugates. *Glycobiology*, 19(9), pp.1010–1017. Available at: <http://ovidsp.ovid.com/ovidweb.cgi?T=JS&NEWS=N&PAGE=fulltext&AN=0002513-200909000-00012&D=ovftj>.
- Beck-Sauge, C.M. & Jarvis, W.R., 1993. Secular trends in the epidemiology of nosocomial fungal infections in the United States 1980-1990. *Journal of Infectious Disease*, 167, pp.1247–1251.
- Berlec, A. & Štrukelj, B., 2013. Current state and recent advances in biopharmaceutical production in Escherichia coli, yeasts and mammalian cells. *Journal of Industrial Microbiology & Biotechnology*, 40(3-4), pp.257–274. Available at: <http://dx.doi.org/10.1007/s10295-013-1235-0>.

- De Bernardez Clark, E., 1998. Refolding of recombinant proteins. *Current Opinion in Biotechnology*, 9(2), pp.157–163. Available at:  
<http://www.sciencedirect.com/science/article/pii/S0958166998801092>.
- Bhaskaran, S. et al., 2005. A Single-chain Fragment Variable Recombinant Antibody against F5 Fimbria of Enterotoxigenic Escherichia coli Inhibits Agglutination of Horse Red Blood Cells Induced by F5 Protein. *Veterinary Research Communications*, 29(6), pp.463–476 LA – English. Available at:  
<http://dx.doi.org/10.1007/s11259-005-1432-z>.
- Bird, R.E. et al., 1988. Single-chain antigen-binding proteins. *Science*, 242 (4877), pp.423–426. Available at:  
<http://www.sciencemag.org/content/242/4877/423.abstract>.
- Blixt, O. et al., 2004. Printed covalent glycan array for ligand profiling of diverse glycan binding proteins. *Proceedings of the National Academy of Sciences of the United States of America*, 101 (49), pp.17033–17038. Available at:  
<http://www.pnas.org/content/101/49/17033.abstract>.
- De Boer, H.A., Comstock, L.J. & Vasser, M., 1983. The tac promoter: a functional hybrid derived from the trp and lac promoters. *Proceedings of the National Academy of Sciences*, 80 (1), pp.21–25. Available at:  
<http://www.pnas.org/content/80/1/21.abstract>.
- Bolanos-Garcia, V.M. & Davies, O.R., 2006. Structural analysis and classification of native proteins from E. coli commonly co-purified by immobilised metal affinity chromatography. *Biochimica et Biophysica Acta (BBA) - General Subjects*, 1760(9), pp.1304–1313. Available at:  
<http://www.sciencedirect.com/science/article/pii/S0304416506000894>.
- Boren, T. et al., 1993. Attachment of Helicobacter pylori to human gastric epithelium mediated by blood group antigens. *Science*, 262 (5141), pp.1892–1895. Available at: <http://www.sciencemag.org/content/262/5141/1892.abstract>.
- Brazil, J.C. et al., 2013.  $\alpha$ 3/4 Fucosyltransferase 3-Dependent Synthesis of Sialyl Lewis A on CD44 Variant Containing Exon 6 Mediates Polymorphonuclear Leukocyte Detachment from Intestinal Epithelium during Transepithelial Migration. *The Journal of Immunology*. Available at:  
<http://www.jimmunol.org/content/early/2013/09/25/jimmunol.1301307.abstract>.
- Brosius, J., Erfle, M. & Storella, J., 1985. Spacing of the -10 and -35 regions in the tac promoter. Effect on its in vivo activity. *Journal of Biological Chemistry*, 260 (6), pp.3539–3541. Available at:  
<http://www.jbc.org/content/260/6/3539.abstract>.
- Burgess-Brown, N.A. et al., 2008. Codon optimization can improve expression of human genes in Escherichia coli: A multi-gene study. *Protein expression and purification*, 59(1), pp.94–102. Available at:  
<http://www.sciencedirect.com/science/article/pii/S104659280800020X>  
[Accessed January 21, 2014].



- Cao, L. et al., 2006. Characterization of a single-chain variable fragment (scFv) antibody directed against the human asialoglycoprotein receptor. *Biotechnology and applied Biochemistry*, 44(Pt 2), pp.65–72. Available at: <http://www.babonline.org/bab/044/bab0440065.htm>.
- Cazet, A. et al., 2010. Tumour-associated carbohydrate antigens in breast cancer. *Breast cancer research*: BCR, 12(3), p.204. Available at: <http://breast-cancer-research.com/content/12/3/204> [Accessed October 20, 2013].
- Celik, E. & Calik, P., 2012. Production of recombinant proteins by yeast cells. *Biotechnology advances*, 30(5), pp.1108–18. Available at: <http://www.sciencedirect.com/science/article/pii/S0734975011001649> [Accessed January 23, 2014].
- Chen, R., 2012. Bacterial expression systems for recombinant protein production: E. coli and beyond. *Biotechnology advances*, 30(5), pp.1102–7. Available at: <http://www.sciencedirect.com/science/article/pii/S0734975011001662> [Accessed January 20, 2014].
- Chen, Y., 2004. A modified osmotic shock for periplasmic release of a recombinant creatinase from Escherichia coli. *Biochemical Engineering Journal*, 19(3), pp.211–215. Available at: <http://linkinghub.elsevier.com/retrieve/pii/S1369703X04000580>.
- Choi, J.H. & Lee, S.Y., 2004. Secretory and extracellular production of recombinant proteins using Escherichia coli. *Applied Microbiology & Biotechnology*, 64(5), pp.625–635. Available at: 10.1007/s00253-004-1559-9.
- Chung, C.T., Niemela, S.L. & Miller, R.H., 1989. One-step preparation of competent Escherichia coli: transformation and storage of bacterial cells in the same solution. *Proceedings of the National Academy of Sciences of the United States of America*, 86(7), pp.2172–5. Available at: <http://www.pubmedcentral.nih.gov/articlerender.fcgi?artid=286873&tool=pmcentrez&rendertype=abstract>.
- Cooper, M.A. et al., 1998. Surface plasmon resonance analysis at a supported lipid monolayer. *Biochimica et Biophysica Acta (BBA) - Biomembranes*, 1373(1), pp.101–111. Available at: <http://www.sciencedirect.com/science/article/pii/S0005273698000911> [Accessed February 12, 2014].
- Coutinho, P.M. et al., 2003. An Evolving Hierarchical Family Classification for Glycosyltransferases. *Journal of Molecular Biology*, 328(2), pp.307–317. Available at: <http://www.sciencedirect.com/science/article/pii/S0022283603003073> [Accessed January 21, 2014].
- Cragg, H. et al., 1997. Fucosidosis: genetic and biochemical analysis of eight cases. *Journal of Medical Genetics*, 34(2), pp.105–110. Available at: <http://jmg.bmj.com/content/34/2/105.abstract>.

- Croce, M. et al., 2007. Lewis x is highly expressed in normal tissues: A comparative immunohistochemical study and literature revision. *Pathology & Oncology Research*, 13(2), pp.130–138. Available at: <http://dx.doi.org/10.1007/BF02893488>.
- Crowther, J.R., 2009. Stages in ELISA. In *The ELISA Guidebook*. Humana Press, pp. 43 – 78.
- Cummings, R.D. & Etzler, M.E., 2009. Antibodies and Lectins in Glycan Analysis. In A. Varki et al., eds. *Essentials of Glycobiology*. Cold Spring Harbor Laboratory Press, pp. 633 – 647.
- Cummings, R.D. & Etzler, M.E., 2009. R-type Lectins. In A. Varki et al., eds. *Essentials of Glycobiology*. Cold Spring Harbor Laboratory Press, pp. 403 – 414.
- Cummings, R.D. & McEver, R.P., 2009. C-type Lectins. In A. Varki et al., eds. *Essentials of Glycobiology*. Cold Spring Harbor (NY): Cold Spring Harbor Laboratory Press. Available at: <http://www.ncbi.nlm.nih.gov/books/NBK1943/>.
- Dahms, N., 2002. P-type lectins. *Biochimica et Biophysica Acta (BBA) - General Subjects*, 1572(2-3), pp.317–340. Available at: <http://www.sciencedirect.com/science/article/pii/S0304416502003173> [Accessed February 15, 2014].
- Dam, T.K. et al., 2005. Galectins Bind to the Multivalent Glycoprotein Asialofetuin with Enhanced Affinities and a Gradient of Decreasing Binding Constants†. *Biochemistry*, 44(37), pp.12564–12571. Available at: <http://dx.doi.org/10.1021/bi051144z>.
- Davies, G. & Henrissat, B., 1995. Structures and mechanisms of glycosyl hydrolases. *Structure*, 3(9), pp.853–859. Available at: <http://www.sciencedirect.com/science/article/pii/S0969212601002209> [Accessed February 17, 2014].
- Day, H.N.D. and B.W., 2010. Theory and Applications of Surface Plasmon Resonance, Resonant Mirror, Resonant Waveguide Grating, and Dual Polarization Interferometry Biosensors. *Sensors (14248220)*, 10(11), pp.9630–9646. Available at: <http://search.ebscohost.com/login.aspx?direct=true&db=a9h&AN=57951181&site=ehost-live>.
- Drickamer, K., 1988. Two distinct classes of carbohydrate-recognition domains in animal lectins. *Journal of Biological Chemistry*, 263 (20), pp.9557–9560. Available at: <http://www.jbc.org/content/263/20/9557.short>.
- Drugmand, J.-C., Schneider, Y.-J. & Agathos, S.N., 2012. Insect cells as factories for biomanufacturing. *Biotechnology advances*, 30(5), pp.1140–57. Available at: <http://www.sciencedirect.com/science/article/pii/S0734975011001790> [Accessed January 21, 2014].

- Einhauer, A. & Jungbauer, A., 2001. The FLAG<sup>TM</sup> peptide, a versatile fusion tag for the purification of recombinant proteins. *Journal of Biochemical and Biophysical Methods*, 49(1-3), pp.455–465. Available at: <http://www.sciencedirect.com/science/article/pii/S0165022X01002135> [Accessed February 17, 2014].
- Engvall, E. & Perlmann, P., 1971. Enzyme-linked immunosorbent assay (ELISA) quantitative assay of immunoglobulin G. *Immunochemistry*, 8(9), pp.871–874. Available at: <http://www.sciencedirect.com/science/article/pii/001927917190454X>.
- Esposito, D. & Chatterjee, D.K., 2006. Enhancement of soluble protein expression through the use of fusion tags. *Current Opinion in Biotechnology*, 17(4), pp.353–358. Available at: <http://www.sciencedirect.com/science/article/pii/S0958166906000875>.
- Etzler, M.E., Surolia, A. & Cummings, R.D., 2009. L-type Lectins. In A. Varki et al., eds. *Essentials of Glycobiology*. Cold Spring Harbor Laboratory Press, Cold Spring Harbor (NY), pp. 415 – 424.
- Feizi, T., 2003. Carbohydrate microarrays — a new set of technologies at the frontiers of glycomics. *Current Opinion in Structural Biology*, 13(5), pp.637–645. Available at: <http://www.sciencedirect.com/science/article/pii/S0959440X03001350> [Accessed February 10, 2014].
- Feizi, T. & Chai, W., 2004. Oligosaccharide microarrays to decipher the glyco code. *Nature reviews. Molecular cell biology*, 5(7), pp.582–588.
- Fox, J.D. & Waugh, D.S., 2003. Maltose-binding protein as a solubility enhancer. *Methods In Molecular Biology Clifton Nj*, 205, pp.99–117. Available at: <http://www.ncbi.nlm.nih.gov/pubmed/12491882>.
- Francis, D.M. & Page, R., 2001. Strategies to Optimize Protein Expression in E. coli. In *Current Protocols in Protein Science*. John Wiley & Sons, Inc. Available at: <http://dx.doi.org/10.1002/0471140864.ps0524s61>.
- Fukui, S. et al., 2002. Oligosaccharide microarrays for high-throughput detection and specificity assignments of carbohydrate-protein interactions. *Nature biotechnology*, 20(10), pp.1011–1017.
- Ghazarian, H., Idoni, B. & Oppenheimer, S.B., 2011. A glycobiology review: carbohydrates, lectins and implications in cancer therapeutics. *Acta histochemica*, 113(3), pp.236–247. Available at: <http://europepmc.org/abstract/MED/20199800>.
- Glynou, K., Ioannou, P.C. & Christopoulos, T.K., 2003. One-step purification and refolding of recombinant photoprotein aequorin by immobilized metal-ion affinity chromatography. *Protein Expression and Purification*, 27(2), pp.384–

390. Available at: <http://www.scopus.com/inward/record.url?eid=2-s2.0-0037297123&partnerID=40&md5=1616e92cd1ada75dd71ebef6fa202c77>.

Goldberg, S., 2008. Mechanical/Physical Methods of Cell Disruption and Tissue Homogenization. In A. Posch, ed. *2D PAGE: Sample Preparation and Fractionation SE - 1*. Methods in Molecular Biology™. Humana Press, pp. 3–22. Available at: [http://dx.doi.org/10.1007/978-1-60327-064-9\\_1](http://dx.doi.org/10.1007/978-1-60327-064-9_1).

Gopal, G. & Kumar, A., 2013. Strategies for the Production of Recombinant Protein in Escherichia coli. *The Protein Journal*, 32(6), pp.419–425. Available at: <http://dx.doi.org/10.1007/s10930-013-9502-5>.

Gottesman, S., 1990. *Gene Expression Technology*, Elsevier. Available at: <http://www.sciencedirect.com/science/article/pii/007668799085013E> [Accessed February 16, 2014].

Gottesman, S., 1989. Genetics of Proteolysis in Escherichia Coli. *Annual Review of Genetics*, 23(1), pp.163–198. Available at: <http://dx.doi.org/10.1146/annurev.ge.23.120189.001115>.

Gout, S., Tremblay, P.-L. & Huot, J., 2008. Selectins and selectin ligands in extravasation of cancer cells and organ selectivity of metastasis. *Clinical & Experimental Metastasis*, 25(4), pp.335–344. Available at: <http://dx.doi.org/10.1007/s10585-007-9096-4>.

Grant, O.C. et al., 2014. Presentation, presentation, presentation! Molecular-level insight into linker effects on glycan array screening data. *Glycobiology*, 24 (1), pp.17–25. Available at: <http://glycob.oxfordjournals.org/content/24/1/17.abstract>.

Grodberg, J. & Dunn, J.J., 1988. ompT encodes the Escherichia coli outer membrane protease that cleaves T7 RNA polymerase during purification. *Journal of Bacteriology*, 170 (3), pp.1245–1253. Available at: <http://jb.asm.org/content/170/3/1245.abstract>.

Gudlaugsson, O. et al., 2003. Attributable mortality of nosocomial candidemia, revisited. *Clinical Infectious Diseases*, 37(9), pp.1172–1177. Available at: <http://www.ncbi.nlm.nih.gov/pubmed/14557960>.

Gunnarsen, K.S. et al., 2010. Periplasmic expression of soluble single chain T cell receptors is rescued by the chaperone FkpA. *BMC Biotechnology*, 10, p.8. Available at: <http://www.pubmedcentral.nih.gov/articlerender.fcgi?artid=2834602&tool=pmc-entrez&rendertype=abstract>.

Hagel, L. & Haneskog, L., 2010. Size-exclusion Chromatography. In *eLS*. John Wiley & Sons, Ltd. Available at: <http://dx.doi.org/10.1002/9780470015902.a0002676.pub2>.

- Han, Y. et al., 1997. Biochemical characterization of *Candida albicans* epitopes that can elicit protective and nonprotective antibodies. *Infection and Immunity*, 65(10), pp.4100–4107.
- Han, Y. & Cutler, J.E., 1995. Antibody response that protects against disseminated candidiasis. *Infection and Immunity*, 63(7), pp.2714–2719.
- Han, Y., Riesselman, M.H. & Cutler, J.E., 2000. Protection against Candidiasis by an Immunoglobulin G3 (IgG3) Monoclonal Antibody Specific for the Same Mannotriose as an IgM Protective Antibody T. R. Kozel, ed. *Infection and Immunity*, 68(3), pp.1649–1654. Available at: <http://www.pubmedcentral.nih.gov/articlerender.fcgi?artid=97325&tool=pmcentrez&rendertype=abstract>.
- Handbook, B.S.S., 2003. *version AA*, BR-1005-71, Biacore, Uppsala, Sweden.
- Hansson, G.C. & Zopf, D., 1985. Biosynthesis of the cancer-associated sialyl-Lea antigen. *Journal of Biological Chemistry*, 260 (16), pp.9388–9392. Available at: <http://www.jbc.org/content/260/16/9388.abstract>.
- Haselhorst, T., Weimar, T. & Peters, T., 2001. Molecular recognition of sialyl Lewis(x) and related saccharides by two lectins. *Journal of the American Chemical Society*, 123(43), pp.10705–10714. Available at: [http://www.ncbi.nlm.nih.gov/entrez/query.fcgi?cmd=Retrieve&db=PubMed&opt=Citation&list\\_uids=11674003](http://www.ncbi.nlm.nih.gov/entrez/query.fcgi?cmd=Retrieve&db=PubMed&opt=Citation&list_uids=11674003).
- Hazen, K.C. et al., 1991. Differential adherence of hydrophobic and hydrophilic *Candida albicans* yeast cells to mouse tissues. *Infection and Immunity*, 59(3), pp.907–912. Available at: <http://www.pubmedcentral.nih.gov/articlerender.fcgi?artid=258346&tool=pmcentrez&rendertype=abstract>.
- Henrissat, B., 1991. A classification of glycosyl hydrolases based on amino acid sequence similarities. *Biochemical Journal*, 280(Pt 2), pp.309–316. Available at: <http://www.pubmedcentral.nih.gov/articlerender.fcgi?artid=1130547&tool=pmcentrez&rendertype=abstract>.
- Henrissat, B. & Davies, G.J., 2000. Glycoside hydrolases and glycosyltransferases. Families, modules, and implications for genomics. *Plant physiology*, 124(4), pp.1515–1519. Available at: <http://europepmc.org/abstract/MED/11115868>.
- Herrmann, J.E., Hendry, R.M. & Collins, M.F., 1979. Factors involved in enzyme-linked immunoassay of viruses and evaluation of the method for identification of enteroviruses. *Journal of Clinical Microbiology*, 10 (2), pp.210–217. Available at: <http://jcm.asm.org/content/10/2/210.abstract>.
- Hobson, R.P. et al., 2004. Loss of cell wall mannosylphosphate in *Candida albicans* does not influence macrophage recognition. *The Journal of Biological*

- Chemistry*, 279(38), pp.39628–39635. Available at:  
<http://www.ncbi.nlm.nih.gov/pubmed/15271989>.
- Hochuli, E. et al., 1988. Genetic Approach to Facilitate Purification of Recombinant Proteins with a Novel Metal Chelate Adsorbent. *Nature Biotechnology*, 6(11), pp.1321–1325. Available at:  
<http://www.nature.com/nbt/journal/v6/n11/abs/nbt1188-1321.html>.
- Hochuli, E., Döbeli, H. & Schacher, A., 1987. New metal chelate adsorbent selective for proteins and peptides containing neighbouring histidine residues. *Journal Of Chromatography*, 411(0), pp.177–184. Available at:  
<http://linkinghub.elsevier.com/retrieve/pii/S0021967300939694>.
- Hoffmann, A. & Roeder, R.G., 1991. Purification of his-tagged proteins in non-denaturing conditions suggests a convenient method for protein interaction studies. *Nucleic acids research*, 19(22), pp.6337–6338. Available at:  
<http://europepmc.org/abstract/MED/1956801>.
- Holmes, E.H., Ostrander, G.K. & Hakomori, S., 1986. Biosynthesis of the sialyl-Lex determinant carried by type 2 chain glycosphingolipids (IV3NeuAcIII3FucnLc4, VI3NeuAcV3FucnLc6, and VI3NeuAcIII3V3Fuc2nLc6) in human lung carcinoma PC9 cells. *Journal of Biological Chemistry*, 261 (8), pp.3737–3743. Available at:  
<http://www.jbc.org/content/261/8/3737.abstract>.
- Hooper, L. V & Gordon, J.I., 2001. Glycans as legislators of host–microbial interactions: spanning the spectrum from symbiosis to pathogenicity. *Glycobiology*, 11 (2), p.1R–10R. Available at:  
<http://glycob.oxfordjournals.org/content/11/2/1R.abstract>.
- Husby, S. et al., 1985. Increased Non-Specific Binding of Heat-Treated Proteins to Plastic Surfaces Analyzed by ELISA and HPLC-Fractionation. *Journal of Immunoassay*, 6(1-2), pp.95–110. Available at:  
<http://www.tandfonline.com/doi/abs/10.1080/01971528508063023>.
- Huston, J.S. et al., 1988. Protein engineering of antibody binding sites: recovery of specific activity in an anti-digoxin single-chain Fv analogue produced in *Escherichia coli*. *Proceedings of the National Academy of Sciences*, 85 (16), pp.5879–5883. Available at: <http://www.pnas.org/content/85/16/5879.abstract>.
- Ilver, D. et al., 1998. Helicobacter pylori Adhesin Binding Fucosylated Histo-Blood Group Antigens Revealed by Retagging. *Science*, 279 (5349), pp.373–377. Available at: <http://www.sciencemag.org/content/279/5349/373.abstract>.
- Imber, M., Glasgow, L. & Pizzo, S., 1982. Purification of an almond emulsin fucosidase on Cibacron blue-sepharose and demonstration of its activity toward fucose-containing glycoproteins. *J. Biol. Chem.*, 257(14), pp.8205–8210. Available at: <http://www.jbc.org/cgi/content/long/257/14/8205> [Accessed November 23, 2012].

- Intasai, N. et al., 2009. Potent inhibition of OKT3-induced T cell proliferation and suppression of CD147 cell surface expression in HeLa cells by scFv-M6-1B9. *Immunobiology*, 214(6), pp.410–421. Available at: <http://www.sciencedirect.com/science/article/pii/S0171298508001599>.
- Jeong, K.J. & Lee, S.Y., 2002. Excretion of Human  $\beta$ -Endorphin into Culture Medium by Using Outer Membrane Protein F as a Fusion Partner in Recombinant Escherichia coli. *Applied and Environmental Microbiology*, 68(10), pp.4979–4985. Available at: <http://aem.asm.org/content/68/10/4979.abstract>.
- Johnson, B.H. & Hecht, M.H., 1994. Recombinant proteins can be isolated from E. coli cells by repeated cycles of freezing and thawing. *Biotechnology Nature Publishing Company*, 12(13), pp.1357–1360. Available at: [http://www.ncbi.nlm.nih.gov/entrez/query.fcgi?db=pubmed&cmd=Retrieve&dopt=AbstractPlus&list\\_uids=7765566](http://www.ncbi.nlm.nih.gov/entrez/query.fcgi?db=pubmed&cmd=Retrieve&dopt=AbstractPlus&list_uids=7765566).
- Johnson, M.A. et al., 2012. Molecular recognition of Candida albicans (1->2)- $\beta$ -mannan oligosaccharides by a protective monoclonal antibody reveals the immunodominance of internal saccharide residues. *The Journal of Biological Chemistry*, pp.1–24. Available at: <http://www.ncbi.nlm.nih.gov/pubmed/22493450>.
- Johnson, S.W. & Alhadef, J.A., 1991. Mammalian alpha-L-fucosidases. *Comparative Biochemistry And Physiology B Comparative Biochemistry*, 99(3), pp.479–488.
- Johnsson, B., Löfås, S. & Lindquist, G., 1991. Immobilization of proteins to a carboxymethyl-dextran-modified gold surface for biospecific interaction analysis in surface plasmon resonance sensors. *Analytical Biochemistry*, 198(2), pp.268–277. Available at: <http://www.sciencedirect.com/science/article/pii/000326979190424R> [Accessed February 6, 2014].
- Kabat, E.A., 1966. The nature of an antigenic determinant. *The Journal of Immunology*, 97(1), pp.1–11.
- Kamena, F. et al., 2008. Synthetic GPI array to study antitoxic malaria response. *Nature chemical biology*, 4(4), pp.238–240.
- Kapust, R.B. & Waugh, D.S., 1999. Escherichia coli maltose-binding protein is uncommonly effective at promoting the solubility of polypeptides to which it is fused. *Protein Science*, 8(8), pp.1668–1674. Available at: <http://www.pubmedcentral.nih.gov/articlerender.fcgi?artid=2144417&tool=pmc-entrez&rendertype=abstract>.
- Karsunke, X.Z. et al., 2012. Development of single-chain variable fragment (scFv) antibodies against hapten benzo[a]pyrene: a binding study. *Analytical and Bioanalytical Chemistry*, 402(1), pp.499–507 LA – English. Available at: <http://dx.doi.org/10.1007/s00216-011-5389-1>.

- Katayama, T. et al., 2004. Molecular cloning and characterization of Bifidobacterium bifidum 1,2- $\alpha$ -L-fucosidase (AfcA), a novel inverting glycosidase (Glycoside hydrolase family 95). *Journal Of Bacteriology*, 186(15), pp.4885–4893.
- Kitagawa, H. & Paulson, J.C., 1993. Cloning and Expression of Human Gal $\beta$ 1,3(4)GlcNAc  $\alpha$ 2,3-Sialyltransferase. *Biochemical and Biophysical Research Communications*, 194(1), pp.375–382. Available at: <http://www.sciencedirect.com/science/article/pii/S0006291X83718309>.
- Knecht, S. et al., 2009. Oligohis-tags: mechanisms of binding to Ni<sup>2+</sup>-NTA surfaces. *Journal of Molecular Recognition*, 22(4), pp.270–279. Available at: <http://dx.doi.org/10.1002/jmr.941>.
- Kobata, A., 1982.  $\alpha$ -L-fucosidases from almond emulsin. In V. G. B. T.-M. in Enzymology, ed. *Complex Carbohydrates Part D*. Academic Press, pp. 625–631. Available at: <http://www.sciencedirect.com/science/article/pii/0076687982830619>.
- Kusters, J.G., van Vliet, A.H.M. & Kuipers, E.J., 2006. Pathogenesis of Helicobacter pylori Infection. *Clinical Microbiology Reviews* , 19 ( 3 ), pp.449–490. Available at: <http://cmr.asm.org/content/19/3/449.abstract>.
- Kyselova, Z. et al., 2008. Breast Cancer Diagnosis and Prognosis through Quantitative Measurements of Serum Glycan Profiles. *Clinical Chemistry* , 54 ( 7 ), pp.1166–1175. Available at: <http://www.clinchem.org/content/54/7/1166.abstract>.
- Lathe, G.H. & Ruthven, C.R., 1956. The separation of substances and estimation of their relative molecular sizes by the use of columns of starch in water. *Biochemical Journal*, 62(4), pp.665–674. Available at: <http://www.biochemj.org/bj/062/bj0620665.htm>.
- Lee, N., Francklyn, C. & Hamilton, E.P., 1987. Arabinose-induced binding of AraC protein to araI2 activates the araBAD operon promoter. *Proceedings of the National Academy of Sciences* , 84 ( 24 ), pp.8814–8818. Available at: <http://www.pnas.org/content/84/24/8814.abstract>.
- Lei, S.P. et al., 1987. Characterization of the Erwinia carotovora pelB gene and its product pectate lyase. *Journal of Bacteriology* , 169 ( 9 ), pp.4379–4383. Available at: <http://jb.asm.org/content/169/9/4379.abstract>.
- Leong, M.K. et al., 2007. Selection and characterization of lipase abzyme from phage displayed antibody libraries. *Biochemical and Biophysical Research Communications*, 361(3), pp.567–573. Available at: <http://www.sciencedirect.com/science/article/pii/S0006291X07014544>.
- Li, F. & Aitken, R., 2004. Cloning of porcine scFv antibodies by phage display and expression in Escherichia coli. *Veterinary Immunology and Immunopathology*,



- 97(1–2), pp.39–51. Available at:  
<http://www.sciencedirect.com/science/article/pii/S0165242703001879>.
- Li, Y. et al., 2002. Cloning and hemolysin-mediated secretory expression of a codon-optimized synthetic human interleukin-6 gene in *Escherichia coli*. *Protein Expression and Purification*, 25(3), pp.437–447. Available at:  
<http://www.sciencedirect.com/science/article/pii/S1046592802000281>  
[Accessed February 18, 2014].
- Lichty, J.J. et al., 2005. Comparison of affinity tags for protein purification. *Protein expression and purification*, 41(1), pp.98–105. Available at:  
<http://www.sciencedirect.com/science/article/pii/S1046592805000276>  
[Accessed January 22, 2014].
- Liedberg, B., Nylander, C. & Lundström, I., 1995. Biosensing with surface plasmon resonance — how it all started. *Biosensors and Bioelectronics*, 10(8), pp.i–ix. Available at:  
<http://www.sciencedirect.com/science/article/pii/0956566395969652> [Accessed February 11, 2014].
- Lim, K.-P., Li, H. & Nathan, S., 2004. Expression and purification of a recombinant scFv towards the exotoxin of the pathogen, *Burkholderia pseudomallei*. *Journal of microbiology Seoul Korea*, 42(2), pp.126–132. Available at:  
<http://www.ncbi.nlm.nih.gov/pubmed/15357306>.
- Listinsky, J.J., Siegal, G.P. & Listinsky, C.M., 2011. The emerging importance of  $\alpha$ -L-fucose in human breast cancer: a review. *American journal of translational research*, 3(4), pp.292–322. Available at:  
<http://www.pubmedcentral.nih.gov/articlerender.fcgi?artid=3158734&tool=pmc&entrez&rendertype=abstract>.
- Liu, Z.-X. et al., 2005. Identification of single-chain antibody fragments specific against SARS-associated coronavirus from phage-displayed antibody library. *Biochemical and Biophysical Research Communications*, 329(2), pp.437–444. Available at:  
<http://www.sciencedirect.com/science/article/pii/S0006291X05002263>.
- Madigan, M.T., 2005. Plasmids as Cloning Vectors. In *Brock Biology of Microorganisms*. SciELO Espana, pp. 256 – 289.
- Madigan, Michael T; Martinko, J.M., 2005. Essentials of Immunology. In *Brock Biology of Microorganisms*. SciELO Espana.
- Magnani, J.L., 2004. The discovery, biology, and drug development of sialyl Lea and sialyl Lex. *Archives of Biochemistry and Biophysics*, 426(2), pp.122–131. Available at: <http://www.ncbi.nlm.nih.gov/pubmed/15158662>.
- Makvandi-Nejad, S. et al., 2011. Selection and expression of recombinant single domain antibodies from a hyper-immunized library against the hapten

- azoxystrobin. *Journal of Immunological Methods*, 373(1–2), pp.8–18. Available at: <http://www.sciencedirect.com/science/article/pii/S0022175911001761>.
- Malik, P. et al., 1996. The  $\alpha(1,3)$ Fucosyltransferase Fuc-TVII Controls Leukocyte Trafficking through an Essential Role in L-, E-, and P-selectin Ligand Biosynthesis. *Cell*, 86(4), pp.643–653. Available at: <http://linkinghub.elsevier.com/retrieve/pii/S0092867400801373>.
- Malhotra, A., 2009. Tagging for Protein Expression. In R. R. B. and M. P. D. B. T.-M. in Enzymology, ed. *Guide to Protein Purification, 2nd Edition*. Academic Press, pp. 239–258. Available at: <http://www.sciencedirect.com/science/article/pii/S0076687909630160>.
- Manimala, J.C. et al., 2007. High-throughput carbohydrate microarray profiling of 27 antibodies demonstrates widespread specificity problems. *Glycobiology*, 17(8), p.17C–23C. Available at: <http://glycob.oxfordjournals.org/content/17/8/17C.abstract>.
- Mayer, M. & Buchner, J., 2004. Refolding of inclusion body proteins. *Methods in Molecular Medicine*, 94(3), pp.239–254. Available at: <http://www.ncbi.nlm.nih.gov/pubmed/14959834>.
- Maynard, J. & Georgiou, G., 2000. ANTIBODY ENGINEERING. *Annual Review of Biomedical Engineering*, 2(1), pp.339–376. Available at: <http://dx.doi.org/10.1146/annurev.bioeng.2.1.339>.
- Miano, M. et al., 2001. Four year follow-up of a case of fucosidosis treated with unrelated donor bone marrow transplantation. *Bone marrow transplantation*, 27(7), pp.747–751. Available at: <http://europepmc.org/abstract/MED/11360116>.
- Michalski, J.-C. & Klein, A., 1999. Glycoprotein lysosomal storage disorders:  $\alpha$ - and  $\beta$ -mannosidosis, fucosidosis and  $\alpha$ -N-acetylgalactosaminidase deficiency. *Biochimica et Biophysica Acta (BBA) - Molecular Basis of Disease*, 1455(2-3), pp.69–84. Available at: <http://www.sciencedirect.com/science/article/pii/S0925443999000770> [Accessed February 17, 2014].
- Mohanty, A.K. & Wiener, M.C., 2004. Membrane protein expression and production: effects of polyhistidine tag length and position. *Protein Expression and Purification*, 33(2), pp.311–325. Available at: <http://www.sciencedirect.com/science/article/pii/S1046592803003401>.
- Movva, N.R., Nakamura, K. & Inouye, M., 1980. Amino acid sequence of the signal peptide of ompA protein, a major outer membrane protein of Escherichia coli. *Journal of Biological Chemistry*, 255(1), pp.27–29. Available at: <http://www.jbc.org/content/255/1/27.abstract>.
- Müller, S. & Hanisch, F.-G., 2002. Recombinant MUC1 Probe Authentically Reflects Cell-specific O-Glycosylation Profiles of Endogenous Breast Cancer Mucin: HIGH DENSITY AND PREVALENT CORE 2-BASED

GLYCOSYLATION . *Journal of Biological Chemistry* , 277 (29 ) , pp.26103–26112. Available at: <http://www.jbc.org/content/277/29/26103.abstract>.

Nallamsetty, S. et al., 2005. Gateway vectors for the production of combinatorially-tagged His6-MBP fusion proteins in the cytoplasm and periplasm of *Escherichia coli*. *Protein Science*, 14(12), pp.2964–2971. Available at: <http://www.pubmedcentral.nih.gov/articlerender.fcgi?artid=2253240&tool=pmc-entrez&rendertype=abstract>.

Narita, T. et al., 1993. Association of expression of blood group-related carbohydrate antigens with prognosis in breast cancer. *Cancer*, 71(10), pp.3044–3053. Available at: [http://dx.doi.org/10.1002/1097-0142\(19930515\)71:10<3044::AID-CNCR2820711026>3.0.CO](http://dx.doi.org/10.1002/1097-0142(19930515)71:10<3044::AID-CNCR2820711026>3.0.CO).

Natsuka, S. et al., 1994. Molecular cloning of a cDNA encoding a novel human leukocyte alpha-1,3-fucosyltransferase capable of synthesizing the sialyl Lewis x determinant. *Journal of Biological Chemistry* , 269 (24 ) , pp.16789–16794. Available at: <http://www.jbc.org/content/269/24/16789.abstract>.

Neufeld, E.F., 1991. Lysosomal storage diseases. *Annual review of biochemistry*, 60, pp.257–280. Available at: <http://europepmc.org/abstract/MED/1883197>.

Nielsen, U.B. et al., 2006. A novel assay for monitoring internalization of nanocarrier coupled antibodies. *BMC Immunology*, 7, p.24. Available at: <http://www.pubmedcentral.nih.gov/articlerender.fcgi?artid=1633733&tool=pmc-entrez&rendertype=abstract>.

Nitz, M. et al., 2002. The unique solution structure and immunochemistry of the *Candida albicans* beta -1,2-mannopyranan cell wall antigens. *The Journal of Biological Chemistry*, 277(5), pp.3440–3446. Available at: <http://www.ncbi.nlm.nih.gov/pubmed/11700318>.

Occhiodoro, T. et al., 1992. Correction of alpha-L-fucosidase deficiency in fucosidosis fibroblasts by retroviral vector-mediated gene transfer. *Human gene therapy*, 3(4), pp.365–369. Available at: <http://europepmc.org/abstract/MED/1525209>.

Okajima, T. et al., 1999. Molecular Cloning of a Novel  $\alpha$ 2,3-Sialyltransferase (ST3Gal VI) That Sialylates Type II Lactosamine Structures on Glycoproteins and Glycolipids. *Journal of Biological Chemistry* , 274 (17 ) , pp.11479–11486. Available at: <http://www.jbc.org/content/274/17/11479.abstract>.

Palmer, I. & Wingfield, P.T., 2004. Preparation and extraction of insoluble (inclusion-body) proteins from *Escherichia coli*. *Current protocols in protein science editorial board John E Coligan et al*, Chapter 6, p.Unit 6.3. Available at: <http://www.ncbi.nlm.nih.gov/pubmed/18429271>.

Le Pendu, J. et al., 2001. ABH and Lewis histo-blood group antigens in cancer. *APMIS*, 109(1), pp.9–26. Available at: <http://dx.doi.org/10.1111/j.1600-0463.2001.tb00011.x>.

- Pfaller, M.A. et al., 2001. International surveillance of bloodstream infections due to *Candida* species: frequency of occurrence and in vitro susceptibilities to fluconazole, ravuconazole, and voriconazole of isolates collected from 1997 through 1999 in the SENTRY antimicrobial surv. *Journal of Clinical Microbiology*, 39(9), pp.3254–3259. Available at: [http://www.ncbi.nlm.nih.gov/entrez/query.fcgi?cmd=Retrieve&db=PubMed&opt=Citation&list\\_uids=11526159](http://www.ncbi.nlm.nih.gov/entrez/query.fcgi?cmd=Retrieve&db=PubMed&opt=Citation&list_uids=11526159).
- Phillips, T.A., VanBogelen, R.A. & Neidhardt, F.C., 1984. Ion gene product of *Escherichia coli* is a heat-shock protein. *Journal of Bacteriology*, 159 (1), pp.283–287. Available at: <http://jb.asm.org/content/159/1/283.abstract>.
- Porath, J., 1960. Gel filtration of proteins, peptides and amino acids. *Biochimica et Biophysica Acta*, 39(2), pp.193–207. Available at: <http://www.sciencedirect.com/science/article/pii/0006300260901530>.
- Porath, J. et al., 1975. Metal chelate affinity chromatography, a new approach to protein fractionation. *Nature*, 258(5536), pp.598–599. Available at: <http://adsabs.harvard.edu/abs/1975Natur.258..598P>.
- Porath, J. & Flodin, P.R., 1959. Gel Filtration: A Method for Desalting and Group Separation. *Nature*, 183(4676), pp.1657–1659. Available at: <http://dx.doi.org/10.1038/1831657a0>.
- Prinz, W.A. et al., 1997. The Role of the Thioredoxin and Glutaredoxin Pathways in Reducing Protein Disulfide Bonds in the *Escherichia coli* Cytoplasm. *Journal of Biological Chemistry*, 272 (25), pp.15661–15667. Available at: <http://www.jbc.org/content/272/25/15661.abstract>.
- Pryor, K.D. & Leiting, B., 1997. High-Level Expression of Soluble Protein in *Escherichia coli* Using a His6-Tag and Maltose-Binding-Protein Double-Affinity Fusion System. *Protein Expression and Purification*, 10(3), pp.309–319. Available at: <http://www.sciencedirect.com/science/article/pii/S1046592897907592>.
- Pusztai, A. et al., 1988. Isolation of soybean trypsin inhibitors by affinity chromatography on anhydrotrypsin-Sepharose 4B. *Analytical Biochemistry*, 172(1), pp.108–112. Available at: <http://www.sciencedirect.com/science/article/pii/0003269788904186> [Accessed February 9, 2014].
- Qi, Y. et al., 2009. Selection of Anti-Sulfadimidine Specific ScFvs from a Hybridoma Cell by Eukaryotic Ribosome Display. *PLoS ONE*, 4(7), p.e6427. Available at: <http://dx.doi.org/10.1371/journal.pone.0006427>.
- Ravn, V. & Dabelsteen, E., 2000. Tissue distribution of histo-blood group antigens. *APMIS*, 108(1), pp.1–28. Available at: <http://dx.doi.org/10.1034/j.1600-0463.2000.d01-1.x>.

- Renkonen, J., Paavonen, T. & Renkonen, R., 1997. Endothelial and epithelial expression of sialyl Lewisx and sialyl Lewisia in lesions of breast carcinoma. *International Journal of Cancer*, 74(3), pp.296–300. Available at: [http://dx.doi.org/10.1002/\(SICI\)1097-0215\(19970620\)74:3<296::AID-IJC11>3.0.CO](http://dx.doi.org/10.1002/(SICI)1097-0215(19970620)74:3<296::AID-IJC11>3.0.CO).
- Rich, R.L. & Myszka, D.G., 2007. Higher-throughput, label-free, real-time molecular interaction analysis. *Analytical biochemistry*, 361(1), pp.1–6. Available at: <http://www.sciencedirect.com/science/article/pii/S0003269706008037> [Accessed February 4, 2014].
- Riggs, P., 2001. Expression and purification of maltose-binding protein fusions. *Current protocols in molecular biology edited by Frederick M Ausubel et al*, Chapter 16(1994), p.Unit16.6. Available at: <http://www.pubmedcentral.nih.gov/articlerender.fcgi?artid=2494979&tool=pmc-entrez&rendertype=abstract>.
- Riggs, P., 2000. Expression and purification of recombinant proteins by fusion to maltose-binding protein. *Molecular Biotechnology*, 15(1), pp.51–63. Available at: <http://dx.doi.org/10.1385/MB:15:1:51>.
- Rillahan, C.D. & Paulson, J.C., 2011. Glycan Microarrays for Decoding the Glycome. *Annual Review of Biochemistry*, 80(1), pp.797–823. Available at: <http://dx.doi.org/10.1146/annurev-biochem-061809-152236>.
- Rini, J.M., Esko, J.D. & Varki, A., 2009. Glycosyltransferases and Glycan-processing Enzymes. In A. Varki et al., eds. *Essentials of Glycobiology*. Cold Spring Harbor Laboratory Press, pp. 63 – 73.
- Routzahn, K. & Waugh, D., 2002. Differential effects of supplementary affinity tags on the solubility of MBP fusion proteins. *Journal of Structural and Functional Genomics*, 2(2), pp.83–92. Available at: <http://dx.doi.org/10.1023/A:1020424023207>.
- Sachdev, D. & Chirgwin, J.M., 1998a. Order of Fusions between Bacterial and Mammalian Proteins Can Determine Solubility in *Escherichia coli*. *Biochemical and Biophysical Research Communications*, 244(3), pp.933–937. Available at: <http://www.sciencedirect.com/science/article/pii/S0006291X98983656>.
- Sachdev, D. & Chirgwin, J.M., 1998b. Solubility of Proteins Isolated from Inclusion Bodies Is Enhanced by Fusion to Maltose-Binding Protein or Thioredoxin. *Protein Expression and Purification*, 12(1), pp.122–132. Available at: <http://www.sciencedirect.com/science/article/pii/S1046592897908263>.
- Sahdev, S., Khattar, S. & Saini, K., 2008. Production of active eukaryotic proteins through bacterial expression systems: a review of the existing biotechnology strategies. *Molecular and Cellular Biochemistry*, 307(1-2), pp.249–264. Available at: <http://dx.doi.org/10.1007/s11010-007-9603-6>.

- Sakurama, H. et al., 2012. Differences in the Substrate Specificities and Active-Site Structures of Two  $\alpha$ -L-Fucosidases (Glycoside Hydrolase Family 29) from *Bacteroides thetaiotaomicron*. *Bioscience, Biotechnology, and Biochemistry*, 76(5), pp.1022–1024.
- Saldova, R. et al., 2007. Ovarian cancer is associated with changes in glycosylation in both acute-phase proteins and IgG. *Glycobiology*, 17(12), pp.1344–1356. Available at: <http://www.ncbi.nlm.nih.gov/pubmed/17884841>.
- Salfeld, J.G., 2007. Isotype selection in antibody engineering. *Nature biotechnology*, 25(12), pp.1369–1372. Available at: <http://europepmc.org/abstract/MED/18066027>.
- Sano, M., Hayakawa, K. & Kato, I., 1992. Purification and characterization of alpha-L-fucosidase from *Streptomyces* species. *The Journal of biological chemistry*, 267(3), pp.1522–7. Available at: <http://www.ncbi.nlm.nih.gov/pubmed/1730698>.
- Sasaki, K. et al., 1994. Expression cloning of a novel alpha 1,3-fucosyltransferase that is involved in biosynthesis of the sialyl Lewis x carbohydrate determinants in leukocytes. *Journal of Biological Chemistry*, 269 (20 ), pp.14730–14737. Available at: <http://www.jbc.org/content/269/20/14730.abstract>.
- Scawen, M.D. & Hammond, P.M., 2000. Downstream processing: Protein extraction and purification. In J. M. Walker & R. Rapley, eds. *Molecular Biology and Biotechnology (4)*. The Royal Society of Chemistry, pp. 461–496. Available at: <http://dx.doi.org/10.1039/9781847551498-00461>.
- Schroeder, H.W. & Cavacini, L., 2010. Structure and function of immunoglobulins. *The Journal of allergy and clinical immunology*, 125(2 Suppl 2), pp.S41–52. Available at: <http://www.sciencedirect.com/science/article/pii/S0091674909014651> [Accessed January 22, 2014].
- Schwarzer, D. et al., 2009. Proteolytic Release of the Intramolecular Chaperone Domain Confers Processivity to Endosialidase F. *Journal of Biological Chemistry*, 284 (14 ), pp.9465–9474. Available at: <http://www.jbc.org/content/284/14/9465.abstract>.
- Scudder, P. et al., 1990. The isolation by ligand affinity chromatography of a novel form of alpha-L-fucosidase from almond. *J. Biol. Chem.*, 265(27), pp.16472–16477. Available at: <http://www.jbc.org/cgi/content/long/265/27/16472> [Accessed November 24, 2012].
- Seddon, A.M., Curnow, P. & Booth, P.J., 2004. Membrane proteins, lipids and detergents: not just a soap opera. *Biochimica et biophysica acta*, 1666(1-2), pp.105–17. Available at: <http://www.sciencedirect.com/science/article/pii/S0005273604001610> [Accessed January 22, 2014].

- Sedov, S.A. et al., 2011. Lysis of *Escherichia coli* cells by lysozyme: discrimination between adsorption and enzyme action. *Colloids and surfaces. B, Biointerfaces*, 88(1), pp.131–3. Available at: <http://www.sciencedirect.com/science/article/pii/S0927776511003705> [Accessed February 12, 2014].
- Shaikh, F.A. et al., 2013. Identifying the Catalytic Acid/Base in GH29  $\alpha$ -L-Fucosidase Subfamilies. *Biochemistry*, 52(34), pp.5857–5864. Available at: <http://dx.doi.org/10.1021/bi400183q>.
- Sharon, N., 2008. Lectins: past, present and future. *Biochemical Society transactions*, 36(Pt 6), pp.1457–1460. Available at: <http://europepmc.org/abstract/MED/19021575>.
- Sharon, N. & Lis, H., 2004. History of lectins: from hemagglutinins to biological recognition molecules. *Glycobiology*, 14 (11 ), p.53R–62R. Available at: <http://glycob.oxfordjournals.org/content/14/11/53R.abstract>.
- Shirano, Y. & Shibata, D., 1990. Low temperature cultivation of *Escherichia coli* carrying a rice lipoxygenase L-2 cDNA produces a soluble and active enzyme at a high level. *FEBS Letters*, 271(1-2), pp.128–130. Available at: <http://www.sciencedirect.com/science/article/pii/001457939080388Y> [Accessed February 17, 2014].
- Sigal, G.B. et al., 1996. A Self-Assembled Monolayer for the Binding and Study of Histidine-Tagged Proteins by Surface Plasmon Resonance. *Analytical Chemistry*, 68(3), pp.490–497. Available at: <http://dx.doi.org/10.1021/ac9504023>.
- Smith, D.F., Song, X. & Cummings, R.D., 2010. Use of glycan microarrays to explore specificity of glycan-binding proteins. *Methods in enzymology*, 480, pp.417–44. Available at: <http://www.sciencedirect.com/science/article/pii/S0076687910800333> [Accessed January 27, 2014].
- Sørensen, H.P. & Mortensen, K.K., 2005. Soluble expression of recombinant proteins in the cytoplasm of *Escherichia coli*. *Microbial cell factories*, 4(1), p.1. Available at: <http://www.microbialcellfactories.com/content/4/1/1> [Accessed January 21, 2014].
- Stellwagen, E., 2009. Chapter 23 Gel Filtration. In R. R. B. and M. P. D. B. T.-M. in *Enzymology*, ed. *Guide to Protein Purification, 2nd Edition*. Academic Press, pp. 373–385. Available at: <http://www.sciencedirect.com/science/article/pii/S0076687909630238>.
- Studier, F.W., 2005. Protein production by auto-induction in high density shaking cultures. *Protein Expression and Purification*, 41(1), pp.207–234. Available at: <http://linkinghub.elsevier.com/retrieve/pii/S1046592805000264>.

- Sulzenbacher, G. et al., 2004. Crystal structure of *Thermotoga maritima* alpha-L-fucosidase. Insights into the catalytic mechanism and the molecular basis for fucosidosis. *The Journal of Biological Chemistry*, 279(13), pp.13119–13128.
- Tarling, C.A. et al., 2003. Identification of the catalytic nucleophile of the family 29 alpha-L-fucosidase from *Thermotoga maritima* through trapping of a covalent glycosyl-enzyme intermediate and mutagenesis. *The Journal of Biological Chemistry*, 278(48), pp.47394–47399. Available at: <http://www.jbc.org/cgi/content/abstract/278/48/47394>.
- Terpe, K.K., 2003. Overview of tag protein fusions: from molecular and biochemical fundamentals to commercial systems. *Applied Microbiology and Biotechnology*, 60(5), pp.523–533. Available at: <http://libgate.library.nuigalway.ie/login?url=http://search.proquest.com/docview/733005956?accountid=12899>.
- Todorovska, A. et al., 2001. Design and application of diabodies, triabodies and tetrabodies for cancer targeting. *Journal of Immunological Methods*, 248(1–2), pp.47–66. Available at: <http://www.sciencedirect.com/science/article/pii/S0022175900003422>.
- Tong, L. et al., 2000. Extracellular expression, purification, and characterization of a winter flounder antifreeze polypeptide from *Escherichia coli*. *Protein expression and purification*, 18(2), pp.175–81. Available at: <http://www.sciencedirect.com/science/article/pii/S1046592899911762> [Accessed February 17, 2014].
- Turner, P., Holst, O. & Karlsson, E.N., 2005. Optimized expression of soluble cyclomaltodextrinase of thermophilic origin in *Escherichia coli* by using a soluble fusion-tag and by tuning of inducer concentration. *Protein expression and purification*, 39(1), pp.54–60. Available at: <http://www.sciencedirect.com/science/article/pii/S1046592804003274> [Accessed February 17, 2014].
- Varki, A. et al., 2009. Discovery and classification of glycan-binding proteins. In A. Varki et al., eds. *Essentials of Glycobiology*. Cold Spring Harbor Laboratory Press, pp. 375 – 386.
- Varki, A., 1994. Review Selectin ligands. *Cancer*, 91(August), pp.7390–7397.
- Vasina, J.A. & Baneyx, F., 1997. Expression of aggregation-prone recombinant proteins at low temperatures: a comparative study of the *Escherichia coli* cspA and tac promoter systems. *Protein expression and purification*, 9(2), pp.211–8. Available at: <http://www.sciencedirect.com/science/article/pii/S1046592896906786> [Accessed February 17, 2014].
- Vasina, J.A. & Baneyx, F., 1996. Recombinant protein expression at low temperatures under the transcriptional control of the major *Escherichia coli* cold



- shock promoter cspA. *Applied and Environmental Microbiology*, 62 (4), pp.1444–1447. Available at: <http://aem.asm.org/content/62/4/1444.abstract>.
- Vogt Jr., R. V et al., 1987. Quantitative differences among various proteins as blocking agents for ELISA microtiter plates. *Journal of Immunological Methods*, 101(1), pp.43–50. Available at: <http://www.sciencedirect.com/science/article/pii/0022175987902146>.
- De Vries, T., Knechtel, R.M.A., et al., 2001. Fucosyltransferases: structure/function studies. *Glycobiology*, 11 (10), p.119R–128R. Available at: <http://glycob.oxfordjournals.org/content/11/10/119R.abstract>.
- De Vries, T., Storm, J., et al., 2001. Production of soluble human  $\alpha$ 3-fucosyltransferase (FucT VII) by membrane targeting and in vivo proteolysis. *Glycobiology*, 11 (9), pp.711–717. Available at: <http://glycob.oxfordjournals.org/content/11/9/711.abstract>.
- Wang, C.-C. et al., 2009. Glycans on influenza hemagglutinin affect receptor binding and immune response. *Proceedings of the National Academy of Sciences*, 106 (43), pp.18137–18142. Available at: <http://www.pnas.org/content/106/43/18137.abstract>.
- Wang, D. et al., 2007. Photogenerated glycan arrays identify immunogenic sugar moieties of Bacillus anthracis exosporium. *PROTEOMICS*, 7(2), pp.180–184. Available at: <http://dx.doi.org/10.1002/pmic.200600478>.
- Wang, J.-W., Asnani, A. & Auzanneau, F.-I., 2010. Synthesis of a BSA-Lex glycoconjugate and recognition of Lex analogues by the anti-Lex monoclonal antibody SH1: The identification of a non-cross reactive analogue. *Bioorganic & Medicinal Chemistry*, 18(20), pp.7174–7185. Available at: <http://www.sciencedirect.com/science/article/pii/S0968089610007856>.
- Weis, W.I. & Drickamer, K., 1996. Structural Basis of Lectin-Carbohydrate Recognition. *Annual Review of Biochemistry*, 65(1), pp.441–473. Available at: <http://dx.doi.org/10.1146/annurev.bi.65.070196.002301>.
- Weisser, N.E. & Hall, J.C., 2009. Applications of single-chain variable fragment antibodies in therapeutics and diagnostics. *Biotechnology Advances*, 27(4), pp.502–520. Available at: <http://www.sciencedirect.com/science/article/pii/S0734975009000548>.
- Wenzel, R.P., 1995. *Nosocomial candidemia: risk factors and attributable mortality.*, Oxford University Press. Available at: <http://cid.oxfordjournals.org/content/20/6/1531.short>.
- Werner, M.H. et al., 1994. Refolding proteins by gel filtration chromatography. *FEBS Letters*, 345(2–3), pp.125–130. Available at: <http://www.sciencedirect.com/science/article/pii/0014579394004013>.

- Willems, P.J. et al., 1999. Spectrum of mutations in fucosidosis. *European Journal of Human Genetics*, 7(1), p.60. Available at: <http://search.ebscohost.com/login.aspx?direct=true&db=a9h&AN=8854537&site=ehost-live>.
- William Studier, F. et al., 1990. *Gene Expression Technology*, Elsevier. Available at: <http://www.sciencedirect.com/science/article/pii/007668799085008C> [Accessed January 22, 2014].
- Wilson, I.A. & Stanfield, R.L., 1994. Antibody-antigen interactions: new structures and new conformational changes. *Current Opinion in Structural Biology*, 4(6), pp.857–867. Available at: <http://www.sciencedirect.com/science/article/pii/0959440X94902674> [Accessed February 5, 2014].
- Yang, Q. et al., 2003. High-level expression of a soluble snake venom enzyme, glosedobin, in *E. coli* in the presence of metal ions. *Biotechnology Letters*, 25(8), pp.607–610. Available at: <http://dx.doi.org/10.1023/A:1023067626846>.
- Yin, J. et al., 2007. Select what you need: a comparative evaluation of the advantages and limitations of frequently used expression systems for foreign genes. *Journal of biotechnology*, 127(3), pp.335–47. Available at: <http://www.sciencedirect.com/science/article/pii/S0168165606006237> [Accessed January 22, 2014].
- Yuan, Q. et al., 1997. Molecular cloning, expression, and characterization of a functional single-chain Fv antibody to the mycotoxin zearalenone. *Applied and Environmental Microbiology*, 63(1), pp.263–269. Available at: <http://aem.asm.org/content/63/1/263.abstract>.
- Yuan, Q. et al., 2009. Screening of high-affinity scFvs from a ribosome displayed library using BIAcore biosensor. *Applied Biochemistry And Biotechnology*, 152(2), pp.224–234. Available at: <http://www.ncbi.nlm.nih.gov/pubmed/18574567>.
- Zale, S.E. & Klibanov, A.M., 1986. Why does ribonuclease irreversibly inactivate at high temperatures? *Biochemistry*, 25(19), pp.5432–5444. Available at: <http://dx.doi.org/10.1021/bi00367a014>.
- Zhu, J., 2012. Mammalian cell protein expression for biopharmaceutical production. *Biotechnology advances*, 30(5), pp.1158–70. Available at: <http://www.sciencedirect.com/science/article/pii/S0734975011001674> [Accessed January 22, 2014].

## Chapter 2: Materials & Methods

### 2.1 Acknowledgements

*Candida albicans* strain 3153A (ATCC 28367) was a kind gift from Prof. Jim Cutler in the Research Institute for Children, New Orleans.

Di-, tri-, and tetramannosides were a kind gift from Prof. David R. Bundle, University of Alberta, Canada.

### 2.2 Materials

#### *Plasmids and cell lines*

Plasmids	Source	Product code
pIT2	Human Single Fold scFv Libraries I + J (Tomlinson I + J)	Not commercially available
pMAL-c5x	New England Biolabs	N8108S
<i>E. coli</i> Cell lines		
HB2151	Human Single Fold scFv Libraries I + J (Tomlinson I + J)	Not commercially available
	K12 <i>ara Δ</i> (lac-proAB) thi/F' proA <sup>+</sup> B lacI <sup>q</sup> lacZΔ M15	
BL21 (DE3)	<i>E. coli</i> B F <sup>-</sup> dcm ompT hsdS(r <sup>B</sup> m <sup>B</sup> ) gal λ (DE3)	200131
	Agilent Technologies	

#### *Kits*

Kit	Source	Product Code
GenElute™ Gel Extraction Kit	Sigma-Aldrich	NA1111-1KT
Invitrogen Platinum® Pfx DNA Polymerase	Life Technologies	11708-013
Quick Ligation Kit	New England Biolabs	M2200S
QIAprep® Spin MiniPrep Kit	Qiagen	27106
QIAquick® Gel Extraction Kit	Qiagen	28704
Stratagen Quick Change® II Site-Directed Mutagenesis Kit	Agilent	200523

#### *Restriction Enzymes*

Restriction Enzyme	Source	Product Code
<i>NcoI</i>	New England Biolabs	R0193S
<i>NotI</i>	New England Biolabs	R0189S
<i>DpnI</i>	New England Biolabs	R0176S
<i>EcoRI</i>	New England Biolabs	R0101S

#### *Antibodies*

Antibody	Source	Product Code
Myc-Tag (9B11) Mouse mAb	Cell Signaling Technology®	#2276
Penta-His Antibody, BSA-free	Qiagen	34660
ImmunoPure® Goat Anti-Mouse IgG (H+L)	ThermoScientific	
Alkaline Phosphatase Conjugated		
ImmunoPure® Goat Anti-Mouse IgG (H+L)	ThermoScientific	
Horseshoe Peroxidase Conjugated		

*DNA and Protein Molecular Weight Ladders*

<b>Molecular Weight Ladder</b>	<b>Source</b>	<b>Product Code</b>
DNA ladder exACTGene 1kb	Fischer Scientific	BP2578100
Superladder - Low 100 bp Ladder	Thermo Scientific	SLL-100
Pre-stained, EZ-Run Rec Ladder	Fischer Scientific	BP36031

*Additional reagents*

<b>Reagent</b>	<b>Source</b>	<b>Product Code</b>
5-Bromo-4-chloro-3-indolylphosphate/ blue tetrazolium solution (BCIP/NBT)	Sigma-Adrich	B6404-100ML
3,3',5,5'-Tetramethylbenzidine liquid substrate for Enzyme Linked Immunosorbent Assay (TMB)	Sigma-Adrich	T0440-100ML
Factor Xa Protease	New England Biolabs	P8010S
L-Fucose-BSA (14 atom spacer)	Dextra	NGP1105
L-Rhamnose-BSA (14 atom spacer)	Dextra	NGP1106
D-Galactose-BSA (14 atom spacer)	Dextra	NGP1107
D-Mannose-BSA (14 atom spacer)	Dextra	NGP1108
N-acetylglucosamine-BSA (14 atom spacer)	Dextra	NGP1101
Lewis X-BSA (3 atom spacer)	Dextra	NGP0302
Sialyl lewis X-BSA (14 atom spacer)	Dextra	NGP1403

*Columns and Filters*

<b>Product</b>	<b>Source</b>	<b>Product Code</b>
Amnicon Ultra-15 Centrifugal Units	Millipore	UFC901008
Immobilon P PVDF membrane 0.45 µm	Millipore	IPVH00010
Cellulose Nitrate (CN) Membrane Filter 0.45 µm	Sartorius	13906-47A CN
Cellulose Nitrate (CN) Membrane Filter 0.2 µm	Sartorius	13507-47A CN
5 ml His Trap FF Crude column	GE Healthcare	17-5286-01
1 ml His Trap FF Crude column	GE Healthcare	11-0004-58
Superdex™ 75 10/300 GL column	GE Healthcare	17-5174-01

*Software & Online Tools*

<b>Software/Online Tools</b>	<b>Used for</b>
SKANIT SOFTWARE 3.0	Reading ELISA measurements
GraphPad Prism 5	Used to plot ELISA graphs
Clustalw	Sequence alignments
ExPASy ProtParam	Protein sequence analysis
GeneRunner	DNA sequence analysis
Unicorn 5.1	AKTA software
Scrubber 2	SPR analysis

*Equipment*

<b>Equipment</b>	<b>Used for</b>
Thermo Scientific Nanodrop 2000c Spectrometer	Measuring cell culture OD, DNA and protein concentration
TECHNE TC-3000	PCR and DNA amplification
Applied Biosystems Veriti 96 Well Thermal Cycler	PCR and DNA amplification
Thermo Scientific Multiscan FC	ELISA plate reader
AKTApurifier	Used for IMAC and SEC

Oligonucleotides

Primer	Sequence	Use
LMB3	5' CGA CCC GCC ACC GCC GCT G 3'	Sequencing in pIT2 plasmid
pHEN	5' CTA TGC GGC CCC ATT CA 3'	Sequencing in pIT2 plasmid
Q5K F <sup>a</sup>	5' GCC ATG GCC CAG GTG <u>AAG</u> CTG CAG GAA TCT GGC 3'	Mutagenesis of C3.1 scFv to B6.1 scFv
Q5K R <sup>b</sup>	5' GCC AGA TTC CTG CAG <u>CTT</u> CAC CTG GGC CAT GGC 3'	Mutagenesis of C3.1 scFv to B6.1 scFv
N56D, T60A F <sup>a</sup>	5' ATT CGT CTG AAA AGC <u>GAC</u> AAC TAT GCG <u>GCC</u> CAT TAT GCG GAG AGC 3'	Mutagenesis of C3.1 scFv to B6.1 scFv
N56D, T60A R <sup>b</sup>	5' GCT CTC CGC ATA ATG <u>GGC</u> CGC ATA GTT <u>GTC</u> GCT TTT CAG ACG AAT 3'	Mutagenesis of C3.1 scFv to B6.1 scFv
S79T, V81I F <sup>a</sup>	5' AGC CGT GAT GAT AGC AAA <u>ACC</u> AGC <u>ATC</u> TAT CTG CAG ATG AAC AAC 3'	Mutagenesis of C3.1 scFv to B6.1 scFv
S79T, V81I R <sup>b</sup>	5' GTT GTT CAT CTG CAG ATA <u>GAT</u> GCT <u>GGT</u> TTT GCT ATC ATC ACG GCT 3'	Mutagenesis of C3.1 scFv to B6.1 scFv
A90V F <sup>a</sup>	5' CAG ATG AAC AAC CTG CGT <u>GTG</u> GAA GAT ACC GGC ATT TAT 3'	Mutagenesis of C3.1 scFv to B6.1 scFv
A90V R <sup>b</sup>	5' ATA AAT GCC GGT ATC TTC <u>CAC</u> ACG CAG GTT GTT CAT CTG 3'	Mutagenesis of C3.1 scFv to B6.1 scFv
S100R <sup>d</sup>	5' GGC ATT TAT TAT TGC ACC <u>AGG</u> AAC GTG GCG ATG GAT 3'	Mutagenesis of C3.1 scFv to B6.1 scFv
S100R <sup>d</sup>	5' ATC CAT CGC CAC GTT <u>CCT</u> GGT GCA ATA ATA AAT GCC 3'	Mutagenesis of C3.1 scFv to B6.1 scFv
MBP F <sup>a</sup>	5' GGT CGT CAG ACT GTC GAT GAA GCC 3'	Sequencing in pMAL-c5x
MBP R <sup>b</sup>	5' TGT CCT ACT CAG GAG AGC GTT CAC 3'	Sequencing in pMAL-c5x
D224A F <sup>a</sup>	5' CCG GAT GTT CTG TGG AAT <u>GCT</u> ATG GGT TGG CCT GAA AAA 3'	Generation of $\alpha$ -L-Fucosidase inactive mutants
D224A R <sup>b</sup>	5' TTT TTC AGG CCA ACC CAT <u>AGC</u> ATT CCA CAG AAC ATC CGG 3'	Generation of $\alpha$ -L-Fucosidase inactive mutants
D224N F <sup>a</sup>	5' CCG GAT GTT CTG TGG AAT <u>AAT</u> ATG GGT TGG CCT GAA AAA 3'	Generation of $\alpha$ -L-Fucosidase inactive mutants
D224N R <sup>b</sup>	5' TTT TTC AGG CCA ACC CAT <u>ATT</u> ATT CCA CAG AAC ATC CGG 3'	Generation of $\alpha$ -L-Fucosidase inactive mutants
5-His-EcoRI <sup>a</sup>	5' AGC TGC GGC GAA <i>TTC</i> ATG GTG ATG ATG ATG TTC TTC AAC TGC 3'	Amplification of D224N with a penta-His tag and EcoRI restriction site

## Buffers

Buffer Name	Composition
1 X SDS-PAGE Running Buffer Composition	0.025 M Tris, 0.192 M Glycine, 0.1% SDS
6 X SDS Non-Reducing Sample Loading Buffer	187.5 mM Tris-HCl pH 6.8, 6% SDS, 30% Glycerol, 0.03% Bromophenol Blue
6X SDS Reducing Sample Loading Buffer	187.5 mM Tris-HCl pH 6.8, 6% SDS, 30% Glycerol, 0.03% Bromophenol Blue, 100 mM DTT
0.25% Coomassie Blue in 95% Ethanol	0.25% Coomassie Blue in 95% Ethanol
10% Ammonium Persulfate Solution	10% Ammonium Persulfate Solution
10% Sodium dodecyl sulfate Solution	10% Sodium dodecyl sulfate Solution
0.1 M NaOH in 95% Ethanol	0.1 M NaOH in 95% Ethanol
EDTA 0.1 M pH 7.5	EDTA 0.1 M pH 7.6
EDTA 0.1 M pH 9.0	EDTA 0.1 M pH 9.1
Endotoxin-free H <sub>2</sub> O	Endotoxin-free H <sub>2</sub> O
Factor Xa Cleavage buffer	20 mM Tris-HCl, 100 mM NaCl and 2 Mm CaCl <sub>2</sub>
HBS-N Buffer	Commercially available from GE Healthcare
IMAC A Buffer	10 mM HEPES, 500 mM NaCl, pH 7.4
IMAC A Buffer + Imidazole	10 mM HEPES, 500 mM NaCl, 10 mM Imidazole, pH 7.4
IMAC B Buffer	10 mM HEPES, 500 mM NaCl, 500 mM Imidazole, pH 7.4
Lysis Buffer	50 mM Tris-HCl, 20% Sucrose, 0.1% Triton X-100, pH 8.0
Phosphate Buffer	0.17 M KH <sub>2</sub> PO <sub>4</sub> , 0.72 M K <sub>2</sub> HPO <sub>4</sub>
Phosphate Buffered Saline (PBS)	Commercially available from Fisher Scientific
Phosphate Buffered Saline, 0.1% Tween 20 (PBST)	Commercially available PBS from Fisher Scientific with Tween 20 added to final required concentration
Resolving Buffer Composition	1.5 M Tris-HCl, pH 8.8
Stacking Buffer Composition	0.5 M Tris-HCl, pH 6.8
Staining solution 1	50% Ethanol, 10% Acetic acid
Staining Solution 2	5% Ethanol, 7.5% Acetic acid, 0.25% Coomassie Blue in 95% ethanol (2 ml)
TSS Buffer	10% PEG-8000, 30 mM MgCl <sub>2</sub> , 5% DMSO in 50 ml of autoclaved LB media
Western Transfer Buffer	48 mM Tris, 39 mM Glycine, 20% Methanol, 1.3 mM SDS, pH 9.2

*Culture media*

<b>Media</b>	<b>Composition/Source</b>
Luria Broth Media (LB)	Commercially available Luria Broth from Fisher Scientific
Luria Broth Agar (LB Agar)	Commercially available Luria Broth Agar from Fisher Scientific
GYEBP	2% Glucose, 0.3% yeast extract, 1% bacto-peptone
Terrific Broth (TB)	2.4% Yeast Extract, 1.2% tryptone, 0.4% glycerol
	Phosphate buffer (50 ml) was added after TB (450 ml) was autoclaved.

## 2.3 Methods

### 2.3.1 Synthesis of C3.1 scFv and $\alpha$ -L-Fucosidase Genes

DNA encoding the nucleic acid sequences for the variable heavy and variable light chains of the C3.1 IgG3 mAb and of the  $\alpha$ -L-Fucosidase were synthesised by GeneArt (Life Technologies Corporation). The C3.1 scFv was constructed in the variable heavy – linker (GGGGS)<sub>3</sub> – variable light chain orientation with 5' *NcoI* and 3' *NotI* restriction sites and the  $\alpha$ -L-Fucosidase was constructed with a 5' *NcoI* and 3' *NotI* restriction sites. In order to have the 5' *NcoI* restriction site, the amino acid sequence had to include a point mutation of residue 2 from isoleucine to alanine (I2A). This will hereafter be known as the wildtype  $\alpha$ -L-fucosidase for this study. The DNA sequences for both were codon optimized for expression in *E. coli* and are included in Appendix I.

### 2.3.2 Preparation of chemically competent cells

Chemically competent *E. coli* cells were prepared using the protocol developed by Chung et al (Chung et al. 1989). A 5ml culture of *E. coli* cells in LB was grown at 37 °C with shaking at 250 rpm for 12 – 16 hours. They were diluted 1:100 into 50 ml of fresh LB media, and growth was continued at 37 °C with shaking at 250 rpm to an OD<sub>600</sub> ~ 0.5. After the cells reached the required OD, the culture was split into two 50 ml Falcon tubes each containing 25 ml and were incubated on ice for 10 mins. The cultures were centrifuged at 3000 rpm at 4 °C for 10 mins. Supernatants were discarded. Each pellet was resuspended in 2.5 ml of chilled TSS buffer. Aliquots of the cells were added to pre-cooled microfuge tubes and were stored at - 80 °C.

### 2.3.3 Transformation of plasmid DNA into *E. coli* cells

A 1  $\mu$ l aliquot of the plasmid was transformed into 50  $\mu$ l *E. coli* chemically competent cells. Cells were incubated on ice for 30 mins and then treated by heat shock at 42 °C for 90 sec. Tubes were incubated on ice for a further 2 mins before addition of 1 ml of LB. Cells were allowed to recover at 37 °C with shaking at 150 rpm for 1 hour and were then centrifuged at 5000 rpm for 5 mins. The supernatant was discarded and the pellet was retained. Pellets were resuspended in 100  $\mu$ l of LB and plated on LB Agar plates containing 50  $\mu$ g/ml CARB. The plates were incubated at 37 °C overnight (12 – 16 hours).



#### 2.3.4 *Overnight cultures and glycerol stock*

A single colony or scraping from a glycerol stock was inoculated into 5 ml of LB media supplemented with 50 µg/ml CARB. The culture was grown at 37 °C for 12 – 16 hours with shaking at 250 rpm. A glycerol stock was prepared by adding 250 µl of 80% glycerol to 750 µl of an overnight culture (3.2.4). The stocks were then stored at - 80 °C.

#### 2.3.5 *Isolation of plasmid DNA*

The overnight culture was centrifuged in a 1.5 ml microfuge tube at 13,300 rpm for 10 mins. The supernatant was removed by decanting, and the remaining culture was centrifuged in the same tube to pellet the bacteria cells. Plasmid DNA was then isolated and purified using the Qiagen QIAprep<sup>®</sup> Spin MiniPrep Kit. Plasmid DNA concentration and purity was determined using a Nanodrop 2000c spectrophotometer.

#### 2.3.6 *Cloning of Genes into the expression vectors*

A 1 µg aliquot of insert DNA and 1 µg of plasmid vector were linearized by digestion with *NcoI* and *NotI* restriction endonucleases at 37 °C for 1 hour. The digested products were purified by DNA gel electrophoresis on a 1% agarose gel. The gel bands were excised from the gel under UV light using a new razor blade for each band. Bands were purified using the QIAquick<sup>®</sup> Gel Extraction Kit and the concentration of each was determined using a Nanodrop 2000c spectrometer. Ligation of the insert into the expression plasmid was carried out using the Quick Ligation<sup>™</sup> Kit. This was done in insert:vector ratios of 1:1, 3:1 and 6:1. The ligated products were transformed into *E. coli* cells via heat shock as previously described. The cells were plated on LB Agar plates containing 50 µg/ml CARB and were incubated at 37 °C overnight.

#### 2.2.7 *Sequencing analysis*

Plasmid DNA was isolated as previously described. All sequencing analyses were carried out using the LMB3 and pHEN primers (Table 3.1) by Eurofins MWG or LGC Genomics. DNA sequences were translated using Gene Runner version 3.05 and aligned with the wild type sequence using the Multiple Sequence Alignment Tool from EBI, Clustalw (<http://www.ebi.ac.uk/Tools/msa/clustalw2/>).

### 2.3.8 Generation of B6.1 and B6.1 mut S100R scFvs via Site-Directed Mutagenesis (SDM)

The C3.1 scFv plasmid DNA and oligonucleotide primers were used to generate the B6.1 scFv using either the Agilent QuikChange<sup>®</sup> II Site-Directed Mutagenesis Kit or Invitrogen Platinum<sup>®</sup> Pfx DNA Polymerase. To generate the B6.1 and B6.1 mut S100R scFvs from the C3.1 scFv template, the site-directed mutagenesis was carried out in four reactions to generate the six point mutations (Table 2.1).

**Table 2.1:** Reaction order to generate the B6.1 and B6.1 mut S100R scFvs from C3.1 scFv template DNA

Template DNA	Mutations introduced	Product Name
<b>Steps to generate the B6.1 scFV</b>		
C3.1 scFv	N56D, T60A	B6.1 scFv mut 1
B6.1 scFv mut 1	S79T, V81I	B6.1 scFv mut 1.2
B6.1 scFv mut 1.2	A90V	B6.1 scFv mut 1.2.3
B6.1 scFv mut 1.2.3	Q5K	B6.1 scFv
<b>Steps to generate the B6.1 mut S100R</b>		
C3.1 scFv	N56D, T60A	B6.1 scFv mut 1
B6.1 scFv mut 1	A90V	B6.1 scFv mut 1.3
B6.1 scFv mut 1.3	S100R	B6.1 scFv mut 1.3.4
B6.1 scFv mut 1.3.4	S79T, V81I	B6.1 mut S100R

The reaction mixes are presented in Table 2.2 for the Agilent QuikChange<sup>®</sup> II Site-Directed Mutagenesis Kit and the Invitrogen Platinum<sup>®</sup> Pfx DNA Polymerase Kit. Reaction volumes were 50 µl total.

**Table 2.2:** Reaction mixtures for Site-Directed Mutagenesis

<b>Agilent QuikChange® II Site-Directed Mutagenesis Kit</b>	
<b>Reagents</b>	<b>Volume</b>
<b>10 X Reaction Buffer</b>	5 $\mu$ l
<b>50 ng template DNA</b>	X $\mu$ l <sup>c</sup>
<b>125 ng forward primer</b>	1 $\mu$ l
<b>125 ng reverse primer</b>	1 $\mu$ l
<b>dNTPs</b>	1 $\mu$ l
<b>ddH<sub>2</sub>O</b>	41 $\mu$ l - X $\mu$ l
<b><i>PfuUltra</i> HF DNA Polymerase</b>	1 $\mu$ l
<b>Invitrogen Platinum® Pfx DNA Polymerase Kit</b>	
<b>Reagents</b>	<b>Volume</b>
<b>10X <i>Pfx</i> Amplification Buffer</b>	5 $\mu$ l
<b>10 PCR<sub>x</sub> Enhancer Solution</b>	5 $\mu$ l
<b>50 mM MgSO<sub>4</sub></b>	1 $\mu$ l
<b>50 ng template DNA</b>	X $\mu$ l <sup>c</sup>
<b>125 ng forward primer</b>	1 $\mu$ l
<b>125 ng reverse primer</b>	1 $\mu$ l
<b>dNTPs</b>	1 $\mu$ l
<b>ddH<sub>2</sub>O</b>	36 $\mu$ l - X $\mu$ l
<b><i>PfuUltra</i> HF DNA Polymerase</b>	0.4 $\mu$ l

<sup>c</sup>Adjusted based on DNA concentration

*Cycling parameters for the generation of B6.1 scFv and B6.1 S100R scFvs*

The mutagenesis kit and cycling parameters used to generate the B6.1 scFv are presented in Table 2.3 and for the B6.1 mut S100R in Table 2.4.

**Table 2.3:** Cycling parameters for the generation of the B6.1 scFv

Mutations	Stage	Temperature	Time	Cycles	Kit
<b>B6.1 mut 1</b> <b>(N56D, T60A)</b>	1	95 °C	5 mins	1	Agilent QuikChange®
	2	95 °C	30 secs	15	II Site-Directed Mutagenesis Kit
		55 °C	1 min		
		68 °C	5 mins		
	3	68 °C	5 mins	1	
		4 °C	∞		
<b>B6.1 mut 1.2</b> <b>(S79T, V81I)</b>	1	95 °C	5 mins	1	Agilent QuikChange®
	2	95 °C	30 secs	15	II Site-Directed Mutagenesis Kit
		53 °C	1 min		
		68 °C	5 mins		
	3	68 °C	5 mins	1	
		4 °C	∞		
<b>B6.1 mut 1.2.3</b> <b>(A90V)</b>	1	95 °C	5 mins	1	Invitrogen Platinum®
	2	95 °C	30 sec	15	Pfx DNA Polymerase
		55 °C	1 mins		
		68 °C	5 mins		
	3	68 °C	5 mins	1	
		4 °C	∞		
<b>B6.1</b> <b>(Q5K)</b>	1	94 °C	5 mins	1	Invitrogen Platinum®
	2	94 °C	1 mins	24	Pfx DNA Polymerase
		68 °C	10 mins		
	3	68 °C	10 mins	1	
		4 °C	∞		

**Table 2.4:** Cycling parameters for the generation of the B6.1 mut S100R scFv

Mutations	Stage	Temperature	Time	Cycles	Kit
<b>B6.1 mut 1 (N56D, T60A)</b>	1	95 °C	5 mins	1	Agilent QuikChange®
	2	95 °C	30 secs	15	II Site-Directed Mutagenesis Kit
		55 °C	1 min		
		68 °C	5 mins		
	3	68 °C	5 mins	1	
4 °C	∞				
<b>B6.1 mut 1.3 (A90V)</b>	1	95 °C	5 mins	1	Agilent QuikChange®
	2	95 °C	30 secs	15	II Site-Directed Mutagenesis Kit
		51.5 °C	1 min		
		68 °C	5 mins		
	3	68 °C	5 mins	1	
4 °C	∞				
<b>B6.1 mut 1.3.4 (S100R)</b>	1	95 °C	5 mins	1	Invitrogen Platinum®
	2	95 °C	30 sec	15	Pfx DNA Polymerase
		55 °C	1 mins		
		68 °C	5 mins		
	3	68 °C	5 mins	1	
4 °C	∞				
<b>B6.1 mut S100R (S79T, V81I)</b>	1	94 °C	5 mins	1	Invitrogen Platinum®
	2	94 °C	1 mins	24	Pfx DNA Polymerase
		68 °C	10 mins		
	3	68 °C	10 mins	1	
4 °C	∞				

To digest the template DNA 1 µl of *DpnI* was added to each reaction and they were incubated at 37 °C for 2 – 12 hours. A 5 µl aliquot of each reaction product was transformed into *E. coli* HB2151 as previously described. Colonies from each plate were picked and inoculated into 5 ml of LB and cultures were grown as previously described. Glycerol stocks were prepared and stored at -80 °C and plasmid DNA was isolated and quantified. Sequencing analysis was carried out as previously described.

### 2.3.9 Generation of $\alpha$ -L-Fucosidase inactive mutants

The wildtype  $\alpha$ -L-Fucosidase plasmid DNA and oligonucleotide primers were used to generate the  $\alpha$ -L-Fucosidase inactive mutants using the Invitrogen Platinum® Pfx DNA Polymerase. The reaction mixes are presented in Table 2.5. Reaction volumes were 50 µl total. Cycling conditions used for each mutagenesis reaction using the Invitrogen Platinum® Pfx DNA Polymerase are described in Table 2.6.

**Table 2.5:** Reaction mixtures for generation of D224A and D224N mutants using Invitrogen Platinum® *Pfx* DNA Polymerase

Reagents	D224N	D224A
10 X <i>Pfx</i> Amplification Buffer	5 µl	5 µl
10 X PCR <sub>x</sub> Enhancer Solution	5 µl	10 µl
50 mM MgSO <sub>4</sub>	1 µl	1 µl
50 ng template DNA	X µl <sup>a</sup>	X µl <sup>a</sup>
125 ng forward primer	1 µl	1 µl
125 ng reverse primer	1 µl	1 µl
dNTPs	1 µl	1 µl
ddH <sub>2</sub> O	36 µl - X µl	31 µl - X µl
<i>PfuUltra</i> HF DNA Polymerase	0.4 µl	0.4 µl

<sup>a</sup>Adjusted depending on DNA concentration

**Table 2.6:** Cycling parameters for mutagenesis reactions carried out using Invitrogen Platinum® *Pfx* DNA Polymerase

Mutations	Stage	Temperature	Time	Cycles
<b>D224A</b>	1	95 °C	5 mins	1
	2	95 °C	1 min	15
		68 °C	10 mins	
	3	68 °C	10 mins	1
		4 °C	∞	
<b>D224N</b>	1	95 °C	5 mins	1
	2	95 °C	30 sec	15
		55 °C	1 min	
	3	68 °C	8 mins	1
		68 °C	8 mins	
		4 °C	∞	

To digest the template DNA *DpnI* (1 µl) was added to each reaction and they were incubated at 37 °C for 2 hour – 12 hours. Each reaction product (5 µl) was transformed into *E.coli* HB2151 as previously described. Colonies from each plate were picked and inoculated into LB (5 ml) supplemented with 50 µg/ml CARB. The cultures were grown as previously described. Glycerol stocks, plasmid DNA and determination of DNA concentration were prepared as described previously.

### 2.3.10 Polymerase Chain Reaction (PCR)

The polymerase chain reaction was used with oligonucleotide primers to amplify the D224N  $\alpha$ -L-Fucosidase to include a C-terminal His tag and an *EcoRI* restriction site. The reaction mixes are presented in Table 2.7. Final reaction volumes were 50  $\mu$ l and 50 pmol of each primer was used. Cycling conditions used for the polymerase chain reaction using the Invitrogen Platinum<sup>®</sup> Pfx DNA Polymerase are described in Table 2.8.

**Table 2.7:** Reaction mixture for generation of D224N with a C-terminal 5-His tag and *EcoRI* restriction site using Invitrogen Platinum<sup>®</sup> Pfx DNA Polymerase

Reagents	D224N-5His-EcoRI
10 X <i>Pfx</i> Amplification Buffer	5 $\mu$ l
10 PCR <sub>x</sub> Enhancer Solution	5 $\mu$ l
50 mM MgSO <sub>4</sub>	1 $\mu$ l
50 ng template DNA	X $\mu$ l <sup>a</sup>
50 pmol LMB3	0.5 $\mu$ l
50 pmol 5His-EcoRI	0.5 $\mu$ l
dNTPs	1 $\mu$ l
ddH <sub>2</sub> O	37 $\mu$ l - X $\mu$ l
<i>PfuUltra</i> HF DNA Polymerase	0.4 $\mu$ l

<sup>a</sup>Adjusted based on DNA concentration

**Table 2.8:** Cycling parameters for polymerase chain reaction to generate D224N with C-terminal 5-His tag and *EcoRI* restriction site using Invitrogen Platinum<sup>®</sup> Pfx DNA Polymerase

Mutations	Stage	Temperature	Time	Cycles
D224N-5His-EcoRI	1	94 °C	3 mins	1
	2	94 °C	30 sec	35
		55 °C	45 sec	
		68 °C	1 min 15 sec	
	3	68 °C	5 mins	1
		4 °C	$\infty$	

The PCR amplified product was purified by electrophoresis on a 1% Agarose gel as described previously. The gel bands which are visible under UV light were excised from the gel using a new razor blade for each band. The DNA bands were purified

using the GenElute™ Gel Extraction Kit and the concentration of each was determined using a Nanodrop 2000c spectrometer.

### 2.3.11 Protein expression protocol

An overnight culture was set up in 5 ml of LB/TB as previously described with the addition of 1% glucose. The culture was grown 37 °C overnight. The 5 ml overnight culture was inoculated into 500 ml of LB or TB, supplemented with 50 µg/ml CARB and 0.1% glucose. The cultures were grown at 37 °C with shaking at 250 rpm to an OD<sub>600</sub> ~ 0.9 - 1.2. Protein expression was induced with 1 mM IPTG and expression was continued at 24 °C with shaking at 250 rpm overnight, or at 37 °C for 4 hours. Cultures were centrifuged at 10,000 rpm for 30 mins. For the scFvs, the supernatant was retained and the pellet was discarded. For the α-L-Fucosidase, the supernatant was discarded and the pellet was retained.

### 2.3.12 Protein isolation

Resuspended cells in lysis buffer (5 ml) and incubated at room temperature (approx 22 °C) for 30 mins. Solutions of DNaseI (0.1 mg/ml), lysozyme (1 mg/ml) and PMSF (1 mM) were added and the mixtures were incubated at 37 °C for 1 hour with shaking at 250 rpm. Cells were sonicated as follows:

1. 30 sec at 50%. Pause for 15 sec.
2. 30 sec at 60%. Pause for 15 sec. Repeat this a second time.
3. 30 sec at 65%. Pause for 15 sec. Repeat this a second time.

The sonicated cells were centrifuged at 10,000 rpm for 30 mins. The supernatant was transferred to a new tube.

### 2.3.13 Immobilised Metal Affinity Chromatography (IMAC)

Before purification the protein supernatant/cell lysate were 0.2 µm sterile filtered or stored at -20 °C. A 5 ml HisTrap FF Crude column (GE Healthcare) was equilibrated with five column volumes of IMAC A buffer. Sterile filtered supernatant/protein lysate was loaded onto the column at a flow rate of 0.5 ml/min – 1.0 ml/min. Subsequently the column was washed with at least ten column volumes of IMAC A buffer to remove any non-specific protein binders and to re-equilibrate the UV absorbance. A step-wise gradient elution of the His-tagged proteins from the HisTrap



FF Crude column with IMAC B buffer was carried out in six steps; 5%, 10%, 20%, 30%, 60% and 100%. All peaks were collected for analysis by SDS-PAGE and Western Blot to determine the purity of the samples.

Eluted protein fractions were concentrated and buffer exchanged into IMAC A buffer by centrifuging at 4200 rpm for 30 mins in Amicon Ultra-15 Centrifugal Filter Units. The protein concentration was measured using a Nanodrop 2000c Spectrophotometer.

### 2.3.14 Sodium-dodecyl-sulphate Polyacrylamide Gel Electrophoresis (SDS-PAGE)

Polyacrylamide gels composed of a 5% stacking gel and 12% resolving gel were prepared by combining the volumes of each solution in Table 2.9. This total volume was enough to pour two 1 mm 10-well gels or one 1.5 mm 15-well gel. The resolving gel was prepared first and poured into the glass assembly, it was then overlaid with 70% ethanol. When the resolving gel had polymerized, the ethanol was removed. The stacking gel was then prepared and poured on top of the resolving gel. The appropriate comb was inserted and the gel was allowed to polymerize for 15 mins.

**Table 2.9:** Composition of SDS-PAGE Stacking and Separating Gels.

	<b>Stacking</b>	<b>Separating</b>
<b>Gel percentage (%)</b>	<b>5</b>	<b>12</b>
<b>40% Acrylamide/bis-Acrylamide (ml)</b>	0.75	3.75
<b>0.5 M Tris-HCl (pH 6.8) (ml)</b>	0.75	-
<b>1.5 M Tris-HCl (pH 8.8) (ml)</b>	-	3.125
<b>10% APS (ml)</b>	0.06	0.125
<b>10% SDS (ml)</b>	0.06	0.125
<b>TEMED (ml)</b>	0.009	0.0075
<b>H<sub>2</sub>O (ml)</b>	4.38	5.375
<b>Total (ml)</b>	6	12.5

The concentrated IMAC purified protein fractions were mixed with 4 µl of 6 X SDS non-reducing sample loading buffer (for the scFvs) or 4 µl of 6 X SDS reducing sample loading buffer (for the  $\alpha$ -L-Fucosidase) and water to a final volume of 24 µl with a maximum of 30 µg total protein. As a molecular weight marker 8 µl of Fisher Prestained EZ-Run Rec Protein Ladder was used. Protein electrophoresis was carried out using the Bio-Rad Mini-PROTEAN<sup>®</sup> Tetra Cell. Power was applied at a constant

voltage of 100 V for 10 mins to stack the proteins in the stacking gel. The voltage was then increased to 180 V for 50 mins to resolve the proteins. Staining of SDS-PAGE gels by Coomassie Blue was carried out following the protocol previously described by Studier (Studier 2005). The SDS-PAGE gel was placed in staining solution 1 (approx 50 ml) in a covered container. This was heated in a microwave to just boiling (approx 30 sec) and then placed on a rocker for 5 mins during which the gel shrinks. Staining solution 1 was discarded and staining solution 2 (approx 50ml) was added. This was heated to just boiling (approx 30 sec) and placed on a rocker. Bands were visible within 30 mins but were allowed to develop overnight. Excess stain was removed by washing the gel with Millipore Type I water.

### 2.3.15 *Western Blot*

Semi-dry western blot transfer was carried out using the BioRad Trans-Blot<sup>®</sup> SD Semi-Dry Electrophoretic Transfer Cell. Western transfer buffer was used to soak 6 pieces of blot paper and equilibrate the SDS-PAGE gel. Immobilon P PVDF membrane was activated with methanol. The western blot transfer was assembled in the following order from anode to cathode: blot paper, PVDF membrane, SDS-PAGE gel, blot paper. The transfer was carried out at 40 V for 45 mins.

After transfer of the protein bands, the remaining sites on the membrane were blocked with a solution of 1% Fish Gelatin in phosphate buffered saline (PBS) by incubation at room temperature (r.t. approx 22°C) for 1 hour. Primary detection antibody  $\alpha$ -penta-His murine monoclonal Ab was diluted 1:2500 in 10 ml of blocking solution and the membrane was incubated at r.t for 1 hour. The membrane was washed 3 X for 10 mins each with PBST at r.t. Goat- $\alpha$ -mouse IgG (H + L) Alkaline Phosphatase was diluted 1:2500 in 10 ml of blocking solution and the membrane was incubated at r.t for 1 hour. The membrane was washed 3 X for 10 mins each with PBST at r.t. BCIP/NBT solution was added to the membrane which was incubated in the dark at r.t for 15 mins to allow the colour to develop. The solution was discarded and the membrane rinsed with Millipore Type I water to stop the colour reaction. The membrane was allowed to dry overnight.

### 2.3.16 Size Exclusion Chromatography (SEC)

If the purity of the protein sample was not sufficient, as determined by SDS-PAGE and Western Blot, a second purification step (a polishing step) was used to increase the purity. Size exclusion chromatography was used as a second purification step to further purify the IMAC purified protein samples where necessary.

A Superdex<sup>TM</sup> 75 10/300 GL column (GE Healthcare) was equilibrated with one column volume of IMAC A buffer. The protein sample to be purified was concentrated to a maximum of 20 mg/ml in a final volume of ~ 300  $\mu$ l in IMAC A buffer. A 500  $\mu$ l sample loop was flushed 3 X with 2.5 ml of 70% ethanol, 3 X with 2.5 ml of Millipore water and 3 X with 2.5 ml of IMAC A buffer. The protein sample was injected onto the column and IMAC A buffer was used as the transport/elution buffer at a maximum flow rate of 0.5 ml/min. Collection of fractions was started approximately 7.0 ml after injection. Aliquots of 300  $\mu$ l were collected in 1.5 ml microfuge tubes and the C3.1 scFv was found to elute at approximately 13 ml post injection. Aliquots of 20  $\mu$ l were run on a 12% SDS-PAGE gel and analysed by Western Blot. Fractions containing pure His-tagged protein were pooled and concentrated to ~200  $\mu$ l and their concentration determined. All samples were stored at 4 °C.

### 2.3.17 Factor Xa Cleavage of D224N-5His from MBP

Cleavage of the maltose binding protein (MBP) from the D224N was carried out using Factor Xa protease. Factor Xa recognizes and cleaves protein sequences after the arginine residue in the following sequence: Ile-(Glu or Asp)-Gly-Arg. A 1  $\mu$ g aliquot of Factor Xa cleaves 50  $\mu$ g of fusion protein. The cleavage reaction was set up as follow: 2 mg of fusion protein in 2 ml of 20 mM Tris-HCl, 100 mM NaCl, 2 mM CaCl<sub>2</sub> and 40  $\mu$ l of Factor Xa at 1 mg/ml. Reaction was incubated at room temperature on a rocker overnight.

To separate the D224N-5His from the MBP, Immobilised Metal Affinity Chromatography was used. A 1 ml HisTrap FF Crude column (GE Healthcare) was used for the separation which was carried out as described previously.

D224N-5His was concentrated and buffer exchanged, protein concentration determination was carried out and eluted fractions were analysed by SDS-PAGE.

### 2.3.18 *Extraction of Candida albicans cell wall components*

#### *Candida albicans Culture Conditions*

For the extraction of the cell wall components from *Candida albicans*, 4 L of yeast culture were prepared. Six 5 ml and one 10 ml starter cultures of *Candida albicans* were prepared with yeast cells stored in 20% glycerol at -80 °C. They were grown in 2% glucose, 0.3% yeast extract, 1% Bacto-peptone media (GYEBP)(Hazen et al. 1991) at 37 °C with shaking at 250 rpm for 20 – 24 hours. These cultures were used to inoculate six 500 ml and one 1 L of GYEBP, which were grown at 37 °C with shaking at 250 rpm for 48 – 72 hours.

#### *Preparation of equipment/reagents*

##### *Glassware*

All glassware was oven baked at 180 °C for at least 4 hours.

##### *Non-baked materials*

Non-baked materials (plastic culture flasks, centrifuge bottles) were treated with 0.1 M NaOH in 95% ethanol at 30 °C for 1 hour. Endotoxin free water was used to rinse all materials.

#### *2-Mercaptoethanol Extraction*

The yeast cells were transferred to four pre-weighed 250 ml centrifuge bottles and were centrifuged at 3000 rpm at 6 °C for 20 mins. The supernatants were discarded and the pellets were retained. This was repeated until all the cultures had been centrifuged. To wash the pellets 25 ml endotoxin-free water was used, this was done twice. The resuspended cells were centrifuging at 3000 rpm at 6 °C for 5 mins. To wash the pellets 25 ml endotoxin-free water was used and they were combined in one bottle before centrifuging at 3000 rpm at 6 °C for 5 mins. The supernatant was discarded and the pellet was retained. The bottle was weighed to determine the wet weight of the yeast cells. Cold 0.1 M EDTA pH 7.5 was used to resuspend the cells (2 ml/g cells wet weight) which were centrifuged at 3000 rpm at 6 °C for 10 mins. The supernatant was discarded and the pellet was retained and stored at room temperature for 30 mins. Room temperature 0.1 M EDTA pH 9.0 was used to resuspend the cells (2 ml/g cells wet weight) and 2-Mercaptoethanol was added to a final concentration of 0.3 M. The bottle was inverted 5 times to mix the contents and this was repeated every 5 mins for 30 mins. The cells were centrifuged at 4200 rpm

at room temperature for 20 mins. The supernatant was 0.45  $\mu\text{m}$  sterile filtered and both the supernatant and pellet were stored at 4 °C.

#### *Ethanol Precipitation*

The supernatant was divided evenly into two 250 ml centrifuge bottles. To the supernatant NaCl (1 M) was added to a final concentration of 50 mM. A volume 1.05 times the supernatant volume of ethanol (95%) was added to the supernatant and this was mixed for 2 mins by constant inversion. The supernatants were centrifuged at 8110 rpm at room temperature for 20 mins. The supernatants were discarded and the pellets were retained. Endotoxin –free water (20 ml) was used to dissolve the pellets which were centrifuged at 8110 rpm at room temperature for 20 mins. The supernatant was transferred to a new 250 ml bottle and 1.05 x the supernatant volume of ethanol (95%) was added. This was mixed for 2 mins by constant inversion and was centrifuged at 8110 rpm at room temperature for 10 mins. The supernatant was transferred to a new 250 ml bottle and NaCl (1 M) was added to a final concentration of 25 mM. This was mixed for 2 mins by constant inversion and then centrifuged at 8110 rpm at room temperature for 10 mins. The supernatant was discarded and the pellet was dissolved in endotoxin-free water (10 ml) and transferred to a pre-weighed 50 ml conical tube. Additional endotoxin free water (1 ml) was used to rinse the flask and this was added to the conical tube. The extract was freeze dried and stock solutions were made up at 10 mg/ml in Millipore Type I water and stored at -20 °C.

#### *2.3.19 Enzyme-linked Immunosorbent Assay (ELISA) for the scFvs*

An indirect ELISA method based on an inhibition ELISA protocol for the C3.1 IgG reported by Nitz et al. (Nitz et al. 2002) was used to determine the binding of the C3.1 scFv to the 2-mercaptoethanol extracted cell wall components from *Candida albicans*. A 96 well polystyrene plate was coated with 100  $\mu\text{l}$  of 2-ME cell wall extract in phosphate buffered saline at 10  $\mu\text{g/ml}$  or 100  $\mu\text{l}$  phosphate buffered saline for controls. The plate was incubated in a humid chamber at 37 °C for 12 – 14 hours. Subsequently the plate was moved from the humid chamber to 4 °C for 1 hour. Contents of the plate were emptied and the plate was washed three times with Millipore Type I water, sealed and stored at -20 °C. The plate was removed from the freezer and allowed to thaw. To block any uncoated sites in the wells 250  $\mu\text{l}$  of a 2%

BSA-PBS solution was added. The plate was incubated at room temperature for 1 hour. Contents were emptied and wells were washed 3 X with PBST. The first column of the plate received a solution containing 200  $\mu$ l of C3.1 scFv in block at 20  $\mu$ g/ml. This was diluted 1:2 across the plate, with 100  $\mu$ l of block added to the last column. The final volume per well was 100  $\mu$ l. The plate was incubated at room temperature for 1 hour. A 1:2500 dilution of  $\alpha$ -penta-His murine monoclonal Ab in block (100  $\mu$ l) was added to each well and the plate was incubated at room temperature for 1 hour. The plate was then washed 3 X with PBST. A 1:2500 dilution of goat- $\alpha$ -mouse horseradish peroxidase in block (100  $\mu$ l) was added to each well and the plate was incubated at room temperature for 1 hour. The plate was washed 3 X with PBST. The substrate 3,3',5,5'-Tetramethylbenzidine (TMB) substrate (100  $\mu$ l) was added to each well and plate was incubated at room temperature until the blue colour had developed. The stop solution 0.2 M H<sub>2</sub>SO<sub>4</sub> (100  $\mu$ l) was added to stop the reaction resulting in a colour change to yellow. The absorbance was read at 450 nm using a Thermo Scientific Multiscan FC Microplate Photometer and data was analysed using GraphPad Prism 5.

### 2.3.20 Enzyme-linked Immunosorbent Assay for $\alpha$ -L-Fucosidase

#### *Indirect ELISA*

An indirect ELISA method was used to determine the binding of D224N-5His to L-Fucose. The coating protocol was carried out as reported by Wang et al. (Wang et al. 2010). A 96 well polystyrene plate was coated with glycan-BSA conjugates in 50 mM carbonate-bicarbonate buffer, pH 9.6 (100  $\mu$ l) at 10  $\mu$ g/ml or 50 mM carbonate-bicarbonate buffer, pH 9.6 (100  $\mu$ l) for controls. The plate was incubated at 4 °C for 12 – 16 hours overnight. Contents of the plate were emptied and the plate was washed three times with phosphate buffered saline (pH 7.4). To block any uncoated sites in the wells 250  $\mu$ l of a 2% BSA-PBS solution was added. The plate was incubated at room temperature for 1 hour. Contents were emptied and wells were washed 3 X with PBST. The first column of the plate received a solution containing 200  $\mu$ l of D224N-5His in block at 10  $\mu$ g/ml. This was diluted 1:2 across the plate except for the last column, which had just 100  $\mu$ l of block. The final volume in all wells was 100  $\mu$ l. The plate was incubated at room temperature for 1 hour. A 1:2500 dilution of  $\alpha$ -penta-His murine monoclonal Ab in block (100  $\mu$ l) was added to each well and the plate was incubated at room temperature for 1 hour. The plate

was then washed 3 X with PBST. A 1:2500 dilution of goat- $\alpha$ -mouse horseradish peroxidase in block (100  $\mu$ l) was added to each well and the plate was incubated at room temperature for 1 hour. The plate was washed 3 X with PBST. The substrate 3,3',5,5'-Tetramethylbenzidine (TMB) substrate (100  $\mu$ l) was added to each well and plate was incubated at room temperature until the blue colour had developed (~ 20 mins). To stop the reaction 0.2 M H<sub>2</sub>SO<sub>4</sub> (100  $\mu$ l) was added to each well resulting in a colour change to yellow. The absorbance was read at 450 nm using a Thermo Scientific Multiscan FC Microplate Photometer and data was analysed using GraphPad Prism 5.

#### *Inhibition ELISA*

An indirect ELISA method was used to determine the binding of D224N-5His to L-Fucose. The coating protocol was carried out as reported by Wang et al. (Wang et al. 2010). A 96 well polystyrene plate was coated with glycan-BSA conjugates in 50 mM carbonate-bicarbonate buffer, pH 9.6 (100  $\mu$ l) at 10  $\mu$ g/ml or 50 mM carbonate-bicarbonate buffer, pH 9.6 (100  $\mu$ l) for controls. The plate was incubated at 4 °C for 12 – 16 hours overnight. Contents of the plate were emptied and the plate was washed three times with phosphate buffered saline (pH 7.4). To block any uncoated sites in the wells 250  $\mu$ l of a 2% BSA-PBS solution was added. The plate was incubated at room temperature for 1 hour. Contents were emptied and wells were washed 3 X with PBST. Each well received a solution containing 50  $\mu$ l of D224N-5His at 20  $\mu$ g/ml, and 50  $\mu$ l of inhibitor in various concentrations from 0  $\mu$ M – 500  $\mu$ M. The plate was incubated at room temperature for 1 hour. A 1:2500 dilution of  $\alpha$ -penta-His murine monoclonal Ab in block (100  $\mu$ l) was added to each well and the plate was incubated at room temperature for 1 hour. The plate was then washed 3 X with PBST. A 1:2500 dilution of goat- $\alpha$ -mouse horseradish peroxidase in block (100  $\mu$ l) was added to each well and the plate was incubated at room temperature for 1 hour. The plate was washed 3 X with PBST. The substrate 3,3',5,5'-Tetramethylbenzidine (TMB) substrate (100  $\mu$ l) was added to each well and plate was incubated at room temperature until the blue colour had developed (~ 20 mins). To stop the reaction 0.2 M H<sub>2</sub>SO<sub>4</sub> (100  $\mu$ l) was added to each well resulting in a colour change to yellow. The absorbance was read at 450 nm using a Thermo Scientific Multiscan FC Microplate Photometer and data was analysed using GraphPad Prism 5.

### 2.3.21 Surface Plasmon Resonance (SPR) studies of the B6.1 scFvs

Surface plasmon resonance studies of the B6.1 mut S100R scFv with the  $\beta$ -1,2-linked di-, tri- and tetramannosides was carried out using the Biacore X100. This work was done with Dr. Nina Weisser. Surface plasmon resonance studies of the B6.1 scFv with the  $\beta$ -1,2-linked trimannosides was carried out using the Reichert SR7500DC (Reichert Technologies). This work was done with Dr. Stephen Cunningham.

Equilibrium studies were performed at 25 °C. The B6.1 mut S100R scFv was covalently immobilized to a carboxymethyl dextran-coated sensor chip (GE Healthcare) and the B6.1 scFv was covalently immobilized to a carboxymethyl dextran-coated sensor chip (Reichert Technologies). To activate the carboxymethyl groups of dextran, 40 mg of *N*-ethyl-*N*'(3-dimethylaminopropyl) carbodiimide (EDC) and 10 mg of *N*-hydroxysuccinimide (NHS) dissolved in 1 ml of Millipore Type I water was used. The scFv antibodies were attached at pH 4.5 in 10 mM sodium acetate buffer at 20  $\mu$ g/ml. A solution of 1.0 M ethanolamine, pH 8.5 was used to block any unreacted sites on the chip. The B6.1 mut S100R scFv was immobilized at levels of  $\sim$  2100 RU in the experimental flow cell and the B6.1 scFv was immobilized at levels of  $\sim$  240 RU in the experimental flow cell. .

All measurements were conducted in HEPES-buffered saline which contained 0.01 M HEPES and 0.15 M NaCl at pH 7.4. Equilibrium analysis was performed at a flow rate of 35  $\mu$ l/min, with 2 min analyte injection and 5 min buffer flow. Concentrations of the di-, tri- and tetrasaccharide measured ranged from 0.97 – 500  $\mu$ M. SPR signals were processed using Scrubber software (version 2.0; BioLogic).

### 2.3.22 Surface Plasmon Resonance (SPR) of D224N-5His

Surface plasmon resonance studies of D224N-5His with the Lewis X (LeX) trisaccharide and Sialyl Lewis X (SLeX) tetrasaccharide using the Reichert SR7500DC (Reichert Technologies) . This work was done with Dr. Stephen Cunningham. Equilibrium studies were performed at 25 °C on the Reichert SR7500DC (Reichert Technologies) surface plasmon resonance (SPR) instrument. The D224N-5His  $\alpha$ -L-Fucosidase was covalently immobilized to a carboxymethyl dextran-coated sensor chip (Reichert Technologies). To activate the carboxymethyl groups of dextran, 40 mg of *N*-ethyl-*N*'(3-dimethylaminopropyl) carbodiimide



(EDC) and 10 mg of *N*-hydroxysuccinimide (NHS) dissolved in 1 ml of Millipore Type I water was used. The D224N-5His was attached in 10 mM sodium acetate buffer, pH 4.5 at 20  $\mu\text{g/ml}$ . A solution of 1.0 M ethanolamine, pH 8.5 was used to block any unreacted sites on the chip. The D224N-5His was immobilized at levels of  $\sim 6000$  RU in the experimental flow cell. All measurements were conducted in phosphate buffered saline, 0.05% Tween, pH 7.4 (PBS, 0.05% Tween, pH 7.4 for SPR – Appendix I). Equilibrium analysis was performed at a flow rate of 25  $\mu\text{l/min}$ , with 1 min analyte injection and 1 min buffer flow. Concentrations of the LeX and SLeX ranged from 0.97 – 500  $\mu\text{M}$ . SPR signals were processed using Scrubber software (version 2.0; BioLogic). Outliers were removed from data analysis.

## References

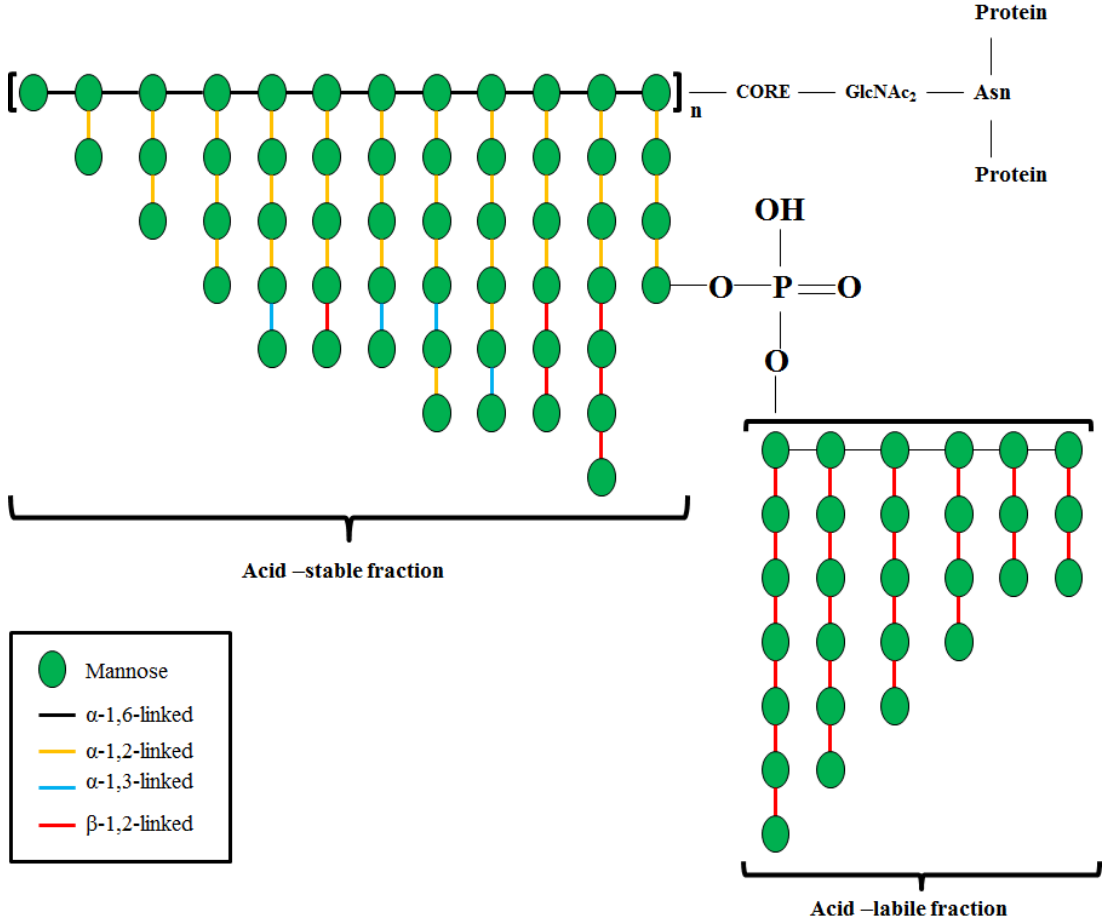
- Chung, C.T., Niemela, S.L. & Miller, R.H., 1989. One-step preparation of competent *Escherichia coli*: transformation and storage of bacterial cells in the same solution. *Proceedings of the National Academy of Sciences of the United States of America*, 86(7), pp.2172–5. Available at: <http://www.pubmedcentral.nih.gov/articlerender.fcgi?artid=286873&tool=pmcentrez&rendertype=abstract>.
- Hazen, K.C. et al., 1991. Differential adherence of hydrophobic and hydrophilic *Candida albicans* yeast cells to mouse tissues. *Infection and Immunity*, 59(3), pp.907–912. Available at: <http://www.pubmedcentral.nih.gov/articlerender.fcgi?artid=258346&tool=pmcentrez&rendertype=abstract>.
- Nitz, M. et al., 2002. The unique solution structure and immunochemistry of the *Candida albicans* beta -1,2-mannopyranan cell wall antigens. *The Journal of Biological Chemistry*, 277(5), pp.3440–3446. Available at: <http://www.ncbi.nlm.nih.gov/pubmed/11700318>.
- Studier, F.W., 2005. Protein production by auto-induction in high density shaking cultures. *Protein Expression and Purification*, 41(1), pp.207–234. Available at: <http://linkinghub.elsevier.com/retrieve/pii/S1046592805000264>.
- Wang, J.-W., Asnani, A. & Auzanneau, F.-I., 2010. Synthesis of a BSA-Lex glycoconjugate and recognition of Lex analogues by the anti-Lex monoclonal antibody SH1: The identification of a non-cross reactive analogue. *Bioorganic & Medicinal Chemistry*, 18(20), pp.7174–7185. Available at: <http://www.sciencedirect.com/science/article/pii/S0968089610007856>.

## Chapter 3: Single-chain variable fragment antibodies for *Candida albicans* glycans

### 3.1 Introduction

*Candida albicans* is normally a harmless commensal organism that can be isolated from healthy individuals from the gastrointestinal tract, or oral and vaginal mucosa, however this pathogenic yeast is also the most common cause of fungal disease in humans (Pfaller et al. 2001; Beck-Sauge & Jarvis 1993). *C. albicans* was the most frequently isolated fungal pathogen (59.7%) in the United States in the period 1980 – 1990 (Beck-Sauge & Jarvis 1993) and between 1997 and 1999, was the cause of 55% of yeast bloodstream infections (Pfaller et al. 2001). Patients with primary immunodeficiencies, or immunocompromised patients, are more susceptible to fungal infections due to *C. albicans*. While fungal infections are less frequent in people with primary immunodeficiencies than bacterial or viral infections, if not treated correctly they can be fatal (Antachopoulos et al. 2007). In immunocompromised people, disseminated candidiasis can often result in death (Wenzel 1995; Gudlaugsson et al. 2003).

Murine monoclonal antibodies C3.1 (IgG3) (Han et al. 2000) and B6.1 (IgM) (Han & Cutler 1995) are specific for the same  $\beta$ -1,2-mannotriose cell wall epitope, which is part of the cell-surface phosphomannan distributed over the surface of the *C. albicans* cells as shown in Figure 3.1 (Han et al. 1997; Hobson et al. 2004; Han et al. 2000). Both of these antibodies provide protection against a lethal dose of the pathogen in a mouse model (Han & Cutler 1995; Han et al. 2000). Contrary to the common paradigm developed by Kabat (Kabat 1966), where oligosaccharides have an increasing inhibitory effect with increasing size, these Abs uniquely have greater binding affinities for the smaller di- and trisaccharides, compared to larger tetra- to hexasaccharides (Nitz et al. 2002). In comparison to B6.1, the binding affinity of C3.1 is 5- and 2-fold greater for the di- and trisaccharides respectively (Nitz et al. 2002). These differences may be explained by six amino acid mutations in the variable heavy region of these Abs.

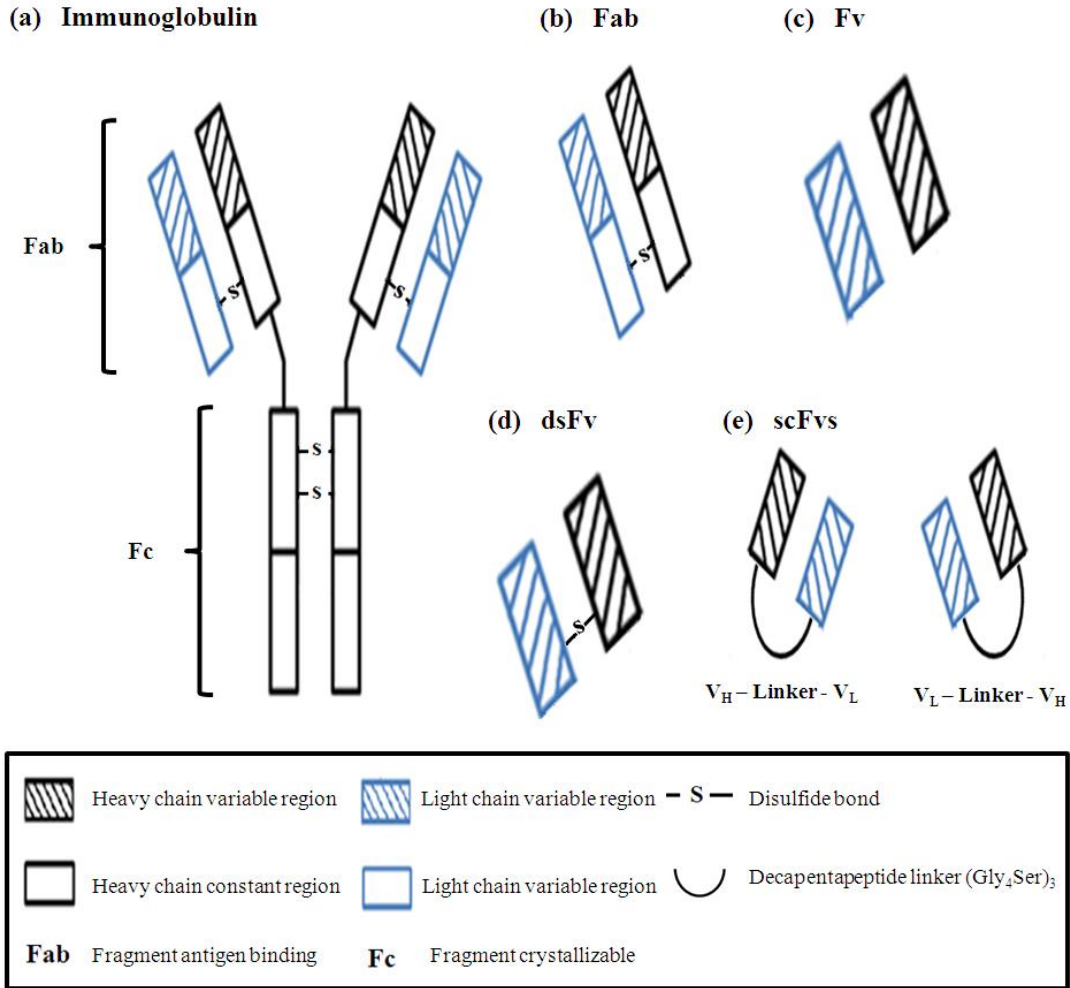


**Figure 3.1:** The surface of *Candida albicans* consists of phosphomannoprotein containing the β-1,2-linked mannotriose (Han et al. 1997; Hobson et al. 2004; Han et al. 2000).

Immunoglobulins can be divided into five classes: IgA, IgD, IgE, IgG and IgM, and of these the IgG is the most abundant isotype accounting for 80% of immunoglobulins in humans (Madigan, Michael T; Martinko 2005).

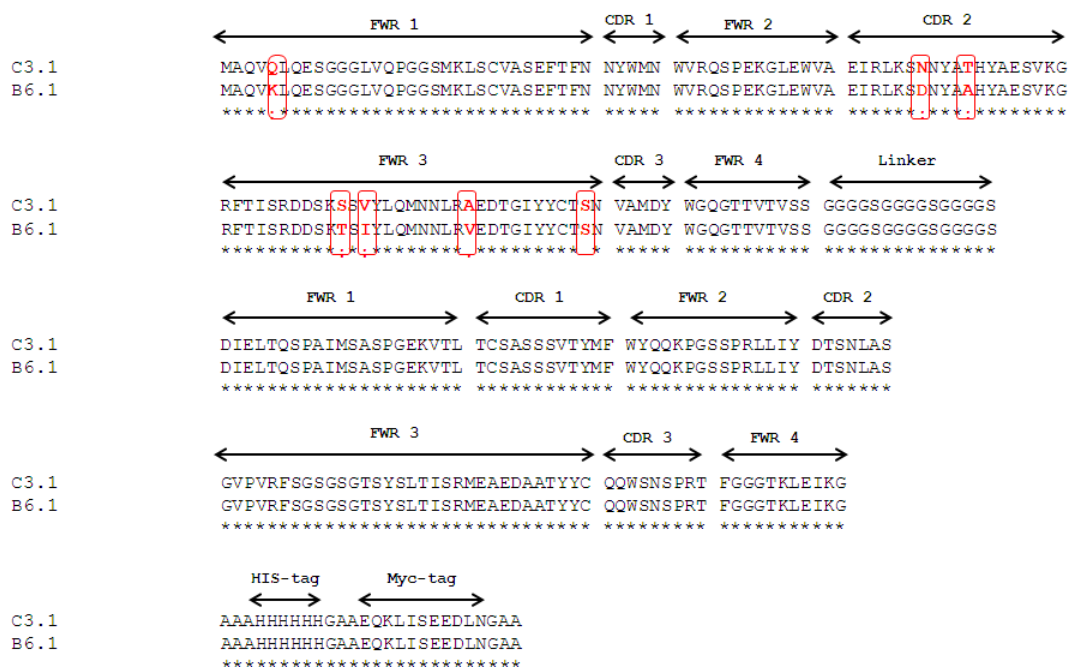
Immunoglobulins are “Y”-shaped structures consisting of two identical heavy chains and two identical light chains as shown in panel (a) in Figure 3.2. The antigen binding regions of an immunoglobulin are known as fragments antigen binding (Fab), and consists of the arms of the antibody. The remaining fragment is known as the fragment crystallisable (Fc), which is responsible for the effector functions (Schroeder & Cavacini 2010). Each antibody consists of two heavy chains and two light chain (Weisser & Hall 2009). The heavy and light chain contains constant domains and one variable domain. The Fab region of the antibody contains the variable domains of the heavy and light chain as well as one constant domain of the light chain as shown in panel (b) Figure 3.2, and are responsible for the specificity and affinity of the immunoglobulins (Weisser & Hall 2009; Maynard & Georgiou 2000). Both the heavy and light chain variable regions contain framework regions and complementary determining regions (CDRs). The CDRs on the surface recognise and bind antigens (Maynard & Georgiou 2000). Both variable heavy ( $V_H$ ) and variable light ( $V_L$ ) chains are necessary for high affinity antigen binding and so the fragment variable (Fv) shown in panel (c) in Figure 3.2, is the smallest fragment that can be used for antigen binding. The  $V_H$  and  $V_L$  chains can associate non-covalently forming the Fv fragment, however, these are prone to dissociation. A disulfide bond joining the  $V_H$  and  $V_L$  chains forms dsFvs shown in panel (d) in Figure 3.2, which are more stable than the Fv fragments. The first single chain variable fragments (scFvs) were described by Bird *et al.* (Bird *et al.* 1988) and Huston *et al.* (Huston *et al.* 1988) and they can be expressed in either the  $V_H$ -linker- $V_L$  or  $V_L$ -linker- $V_H$  orientation as shown in panel (e) in Figure 3.2, with a short polypeptide linker used to join the chains together (Maynard & Georgiou 2000). The flexible decapentapeptide (Gly<sub>4</sub>Ser)<sub>3</sub> is the most common linker (Huston *et al.* 1988), having a length of 15 residues and can allow for assembly of the  $V_H$  and  $V_L$  domains into the natural Fv orientation (Todorovska *et al.* 2001). Shorter linker lengths result in the scFvs forming multimers. For example, linker lengths of 3 – 12 residues, result in a scFv associating with a second scFv forming a dimer, while linkers less than three residues result in scFvs forming trimers or tetramers (Todorovska *et al.* 2001).

scFvs can be expressed in *E. coli* and in their monomeric form are approximately 26-28 kDa .



**Figure 3.2:** General structure of (a) an immunoglobulin (Ig) showing the fragment antigen binding, (b) a fragment antigen binding (Fab), (c) a fragment variable (Fv), (d) a disulfide stabilized Fv (dsFv), and (e) a single chain variable fragment (scFv) in the variable heavy – linker – variable light, and variable light – linker – variable heavy orientation.

We are interested in understanding the structural mechanisms of binding of both the C3.1 scFv and B6.1 scFv antibodies. The C3.1 and B6.1 scFvs differ by only six amino acid residues, two of which are present in the complementary determining region 2 (N56D and T60A), and the other four in the framework regions 1 (Q5K) and 3 (S79T, V81I and A90V) as shown in Figure 3.3. As the complementary determining regions and in particular CDR 2 and CDR 3, are considered the antigen binding regions and the framework regions are the scaffold regions displaying the CDRs for antigen binding, it would be interesting to study the contribution of each amino acid on binding. To investigate the roles of point mutations on antigen affinity, we have engineered a recombinant single-chain variable fragment scFv, consisting of the variable heavy and light chains of the C3.1 IgG3. Using site-directed mutagenesis we have also generated scFvs encoding B6.1 and the B6.1 subclone point mutations using C3.1 as template. Here we report on the expression, purification and analysis of the binding of these scFvs via ELISA and surface plasmon resonance.

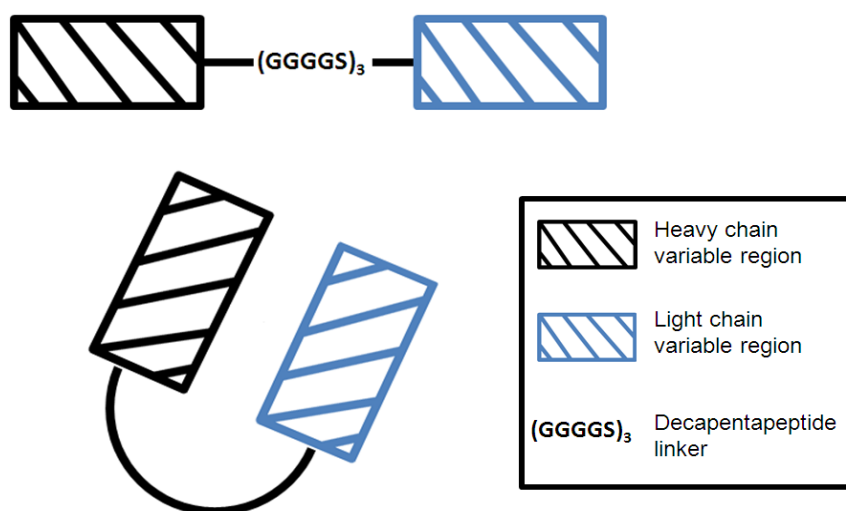


**Figure 3.3:** Sequence alignment of the C3.1 and B6.1 variable heavy and light chains, showing the framework regions (FWR), complementary determining regions (CDR) and the six amino acid differences highlighted by a red box.

## 3.2 Results and Discussion

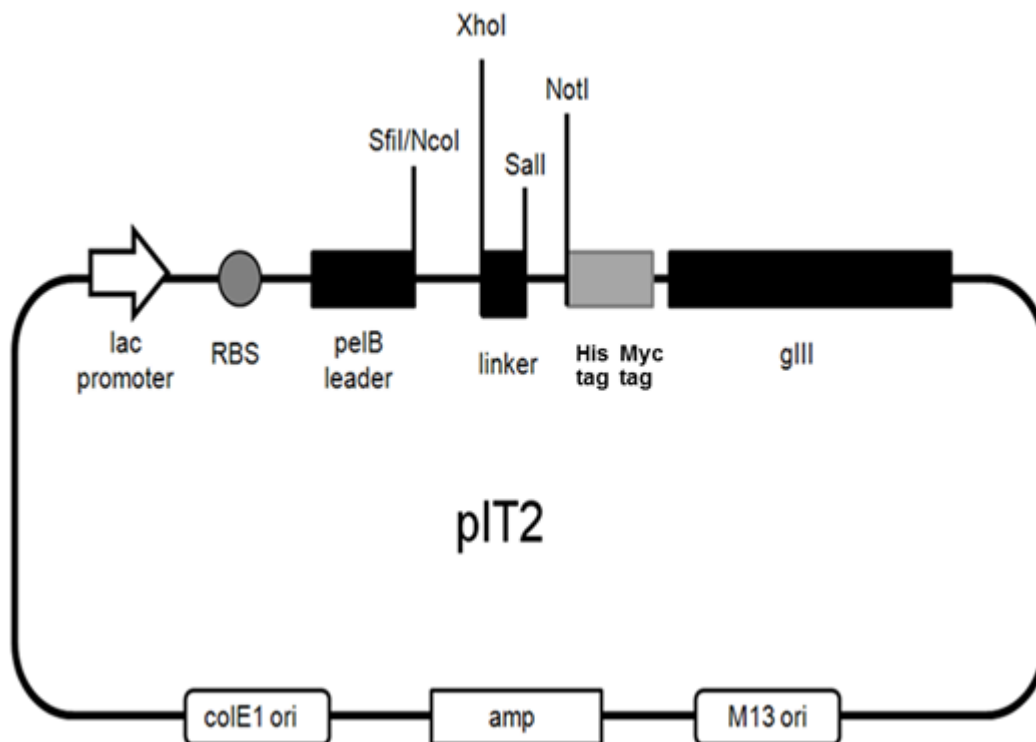
### 3.2.1 Cloning of the C3.1 single-chain variable fragment

A single chain variable fragment (scFv) was synthesised by GeneArt<sup>®</sup> based on the variable heavy and variable light chains of the C3.1 IgG3 monoclonal antibody. The C3.1 scFv DNA sequence showing the 5' *NcoI* and 3' *NotI* restriction sites and protein translation sequence are in Appendix I. Orientation of the C3.1 scFv was in the variable heavy – variable light orientation, with a decapentapeptide (GGGGS)<sub>3</sub> flexible linker (Huston et al. 1988) as shown in Figure 3.4. The C3.1 scFv was cloned into the pIT2 phagemid vector shown in Figure 3.5 introducing a C-terminal hexahistidine tag and myc-tag.



**Figure 3.4:** A single-chain variable fragment in the variable heavy – linker – variable light orientation with a (Gly<sub>4</sub>Ser)<sub>3</sub> decapentapeptide linker.





**Figure 3.5:** pIT2 vector plasmid map showing the 5' *NcoI* and 3' *NotI* restriction sites, as well as the C-terminal hexahistidine tag (His-tag) and myc-tag.

### 3.2.2 Generation of B6.1 scFvs

The C3.1 and B6.1 antibodies have been shown by ELISA  $IC_{50}$  data to have a stronger affinity for di- and trisaccharides in comparison to the larger tetra- to hexasaccharides (Nitz et al. 2002). We are interested in the binding properties of these two antibodies as the C3.1 (IgG3) and B6.1 (IgM) differ by only six amino acids in their variable heavy region. To generate the B6.1 scFv we used site directed mutagenesis. For template DNA we used the C3.1 scFv, and four primer sets (sequences shown in materials) to introduce the six point mutations. The products from the mutagenesis were digested with *DpnI* to remove the parental DNA, and then transformed into *E. coli* HB2151 cells. After ampicillin selection, colonies were cultured and the plasmids sent for sequencing, using the LMB3 and pHEN primers (sequences shown in materials) to confirm the DNA sequence. When a mutation was successfully introduced, the mutant plasmid DNA was then used as template DNA to generate the next mutant and so on until all mutations had been introduced to

generate the B6.1 scFv, the order of which is shown in Table 2.1. A number of additional B6.1 scFv subclones were also generated as shown in Appendix II. Optimization was required to generate all the subclones, as shown in Appendix II.

The sequence for the first B6.1 scFv clone generated is shown in Figure 3.6. This sequence was originally thought to be the correct sequence for the variable heavy and light chain based on the B6.1 IgM antibody; however it was found to be missing one mutation (Q5K) and contained an additional mutation S100R. It was therefore renamed to B6.1 mut S100R. This clone was also expressed, purified and characterised, and for the rest of this discussion it will be referred to as S100R to differentiate it from the true B6.1 scFv sequence in Figure 3.7, which contains the correct Q5K mutation and does not have the extra incorrect S100R mutation.

```

C3.1      MAQVQLQE SGGGLVQPGGSMKLS CVASEFTFN NYWMNWVRQS PEKG
S100R     MAQVQLQE SGGGLVQPGGSMKLS CVASEFTFN NYWMNWVRQS PEKG
          *****

C3.1      LEWVAE IRLKSN NYATHYAES VKGRFT ISRDDSKSSVYLQMN NLRRA
S100R     LEWVAE IRLKSD NYAAHYAES VKGRFT ISRDDSKTSIYLQMN NLRV
          *****

C3.1      EDTGIYCTSNVAMDYWGQGT TVTVSSGGGSGGGGSGGGGSDIEL
S100R     EDTGIYCTRN VAMDYWGQGT TVTVSSGGGSGGGGSGGGGSDIEL
          *****

C3.1      TQSPAIMSASPGEKVT LTCASSSVTYMFWYQ QKPGSSPRL LIYDT
S100R     TQSPAIMSASPGEKVT LTCASSSVTYMFWYQ QKPGSSPRL LIYDT
          *****

C3.1      SNLASGVPVRFSGSGSGT SYSLTISRMEAEDAAT YCQQWSNSPRT
S100R     SNLASGVPVRFSGSGSGT SYSLTISRMEAEDAAT YCQQWSNSPRT
          *****

C3.1      FGGGTKLEIKGAAAH HHHHGAAEQKLISEEDLNGAA
S100R     FGGGTKLEIKGAAAH HHHHGAAEQKLISEEDLNGAA
          *****

```

**Figure 3.6:** Sequence alignment of C3.1 and S100R scFvs. Mutations were introduced in order as in Table 2.1.

```

C3.1  MAQVQLQESGGGLVQPGGSMKLSCVASEFTFNNYWMNWVRQSPEKG
B6.1  MAQVKLQESGGGLVQPGGSMKLSCVASEFTFNNYWMNWVRQSPEKG
      *****
      :*****

C3.1  LEWVAEIRLKSNNYATHYAESVKGRFTISRDDSKSSVYLQMNNLRA
B6.1  LEWVAEIRLKSNDYAAHYAESVKGRFTISRDDSKTSTIYLQMNNLRV
      *****
      :***:*****
      :*:*****

C3.1  EDTGIYYCTSNVAMDYWGQTTVTVSSGGGGSGGGGSDIEL
B6.1  EDTGIYYCTSNVAMDYWGQTTVTVSSGGGGSGGGGSDIEL
      *****

C3.1  TQSPAIMSA SPGEKVTLTCSASSSVTYMFWYQKPGSSPRLLIYDT
B6.1  TQSPAIMSA SPGEKVTLTCSASSSVTYMFWYQKPGSSPRLLIYDT
      *****

C3.1  SNLASGVPVRFSGSGGTSYSLTISRMEAEDAATYYCQQWSNSPRT
B6.1  SNLASGVPVRFSGSGGTSYSLTISRMEAEDAATYYCQQWSNSPRT
      *****

C3.1  FGGGTKLEIKGAAAHHHHHGAAEQKLI SEEDLNAA
B6.1  FGGGTKLEIKGAAAHHHHHGAAEQKLI SEEDLNAA
      *****

```

**Figure 3.7:** Sequence alignment of C3.1 and B6.1 scFvs. Mutations were introduced in order as in Table 2.1.

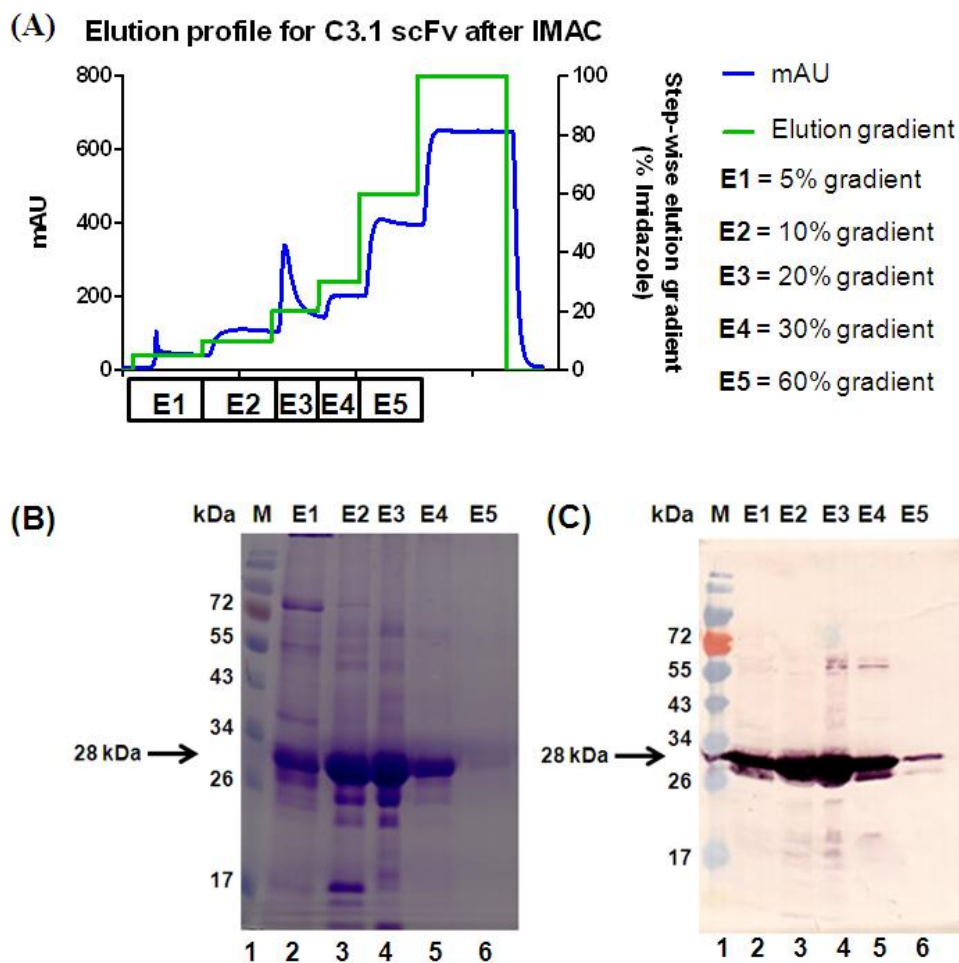
### 3.2.3 Expression of the C3.1, B6.1 and S100R single-chain variable fragment

The non-suppressor *E. coli* HB2151 cells were used for expression of the C3.1 scFv. Protein production was under the control of the lac promoter which was induced in the presence of 1 mM IPTG at 24 °C overnight. A pelB leader sequence is present upstream of the scFv which directs expression of the scFv to the periplasmic space of the *E. coli* cells. The C3.1 scFv was found to be secreted into the culture supernatant (data not shown) and this has been observed in other scFvs expressed in *E. coli* HB2151 cells (Yuan et al. 1997; Li & Aitken 2004; Cao et al. 2006; Intasai et al. 2009; Makvandi-Nejad et al. 2011). It was reported by Yuan et al (Yuan et al. 2009), that extended induction with IPTG, up to 20 hours, resulted in an increase in protein being secreted into the culture supernatant. Shorter induction times, of approximately 5 hours, in a number of studies, show the protein being present in the periplasm (Yuan et al. 2009; Lim et al. 2004; Liu et al. 2005; Bhaskaran et al. 2005; Leong et al. 2007; Qi et al. 2009; Karsunke et al. 2012)

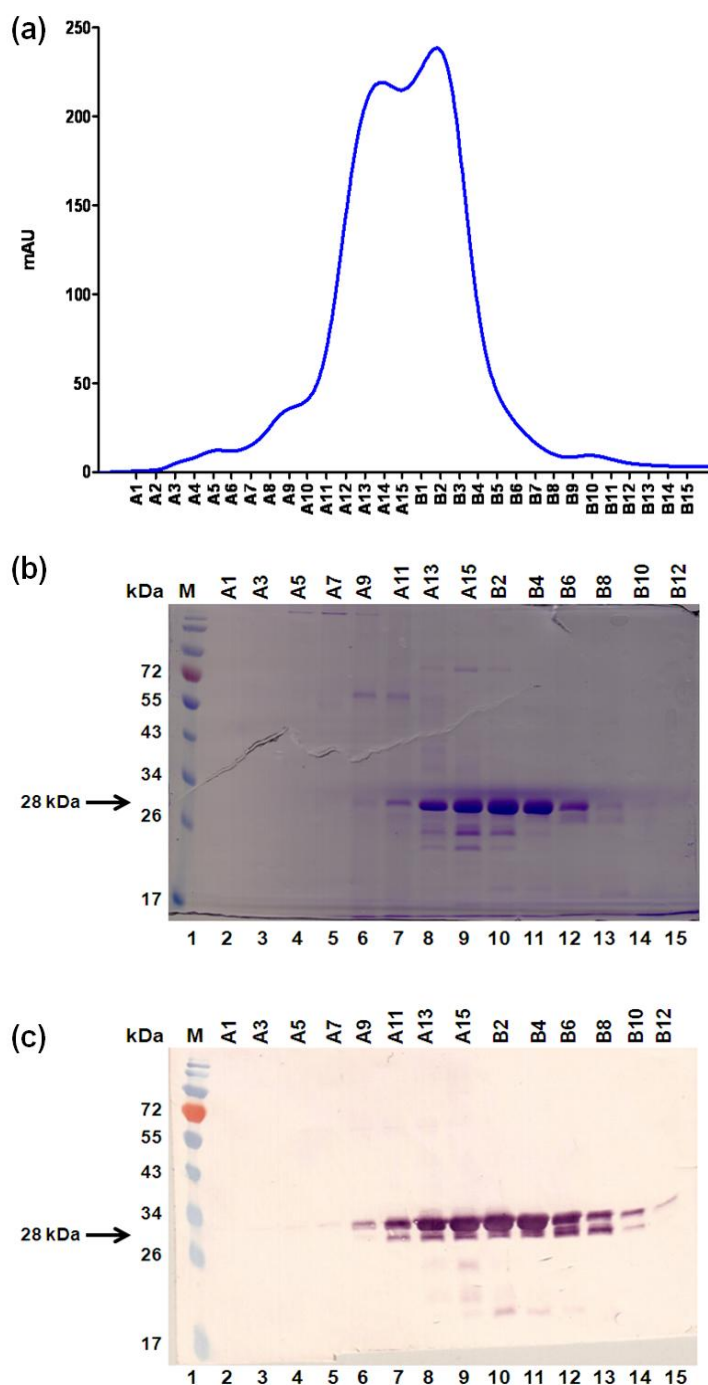
After induction, the C3.1 scFv cultures were centrifuged to pellet the cells. The culture supernatant was 0.2 µM sterile filtered before IMAC purification using a 5 ml HisTrap FF crude column. A typical IMAC chromatograph is shown in panel (a) in Figure 3.8. All eluted fractions were collected and concentrated approximately 30 fold before analysis on a non-reducing 12 % SDS-PAGE gel and western blot as shown in panel (b) and panel (c) respectively in Figure 3.8. Western blots were probed with an anti-His tag murine mAb and showed the approximate molecular weight of the C3.1 scFv as 28 kDa. Theoretical molecular weight was calculated using the ExPASy ProtParam tool (Artimo et al. 2012) and results are shown in Table 3.1. Additional purification was carried out using SEC. A typical SEC chromatograph is shown in panel (a) in Figure 3.9. Aliquots from the eluted fractions from SEC were analysed by SDS-PAGE as shown in panel (b) in Figure 3.9 and western blot as shown in panel (c) in Figure 3.9.

**Table 3.1:** Theoretical molecular weights of C3.1, B6.1 and S100R scFvs

scFv	Theoretical Molecular Weight
C3.1 scFv	28495 Da
S100R scFv	28591 Da
B6.1 scFv	28522 Da

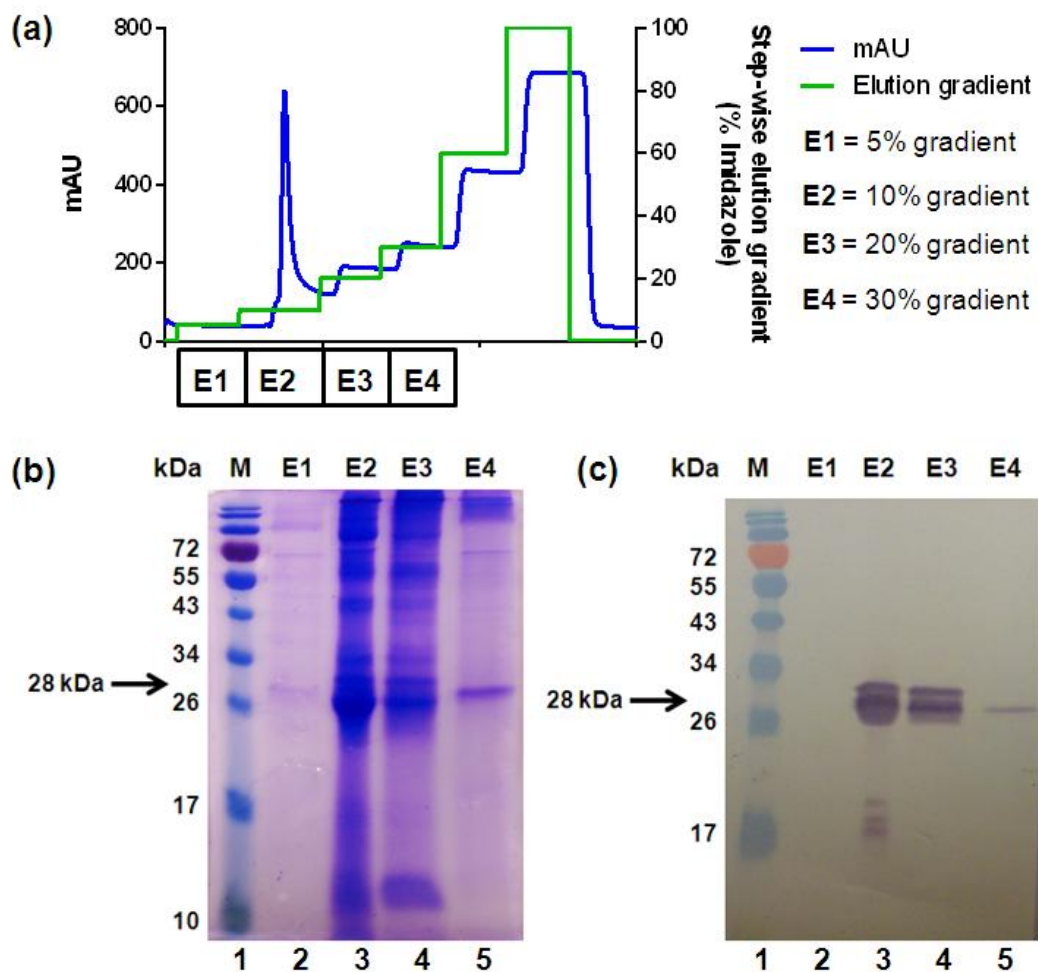


**Figure 3.8:** Purification of the C3.1 scFv using IMAC chromatography and analysis by SDS-PAGE and Western blot. (a) A typical chromatogram showing the step-wise gradient elution. (b) SDS-PAGE and (c) western blot analysis of C3.1 scFv after IMAC. M = molecular weight ladder (kDa), E1= 5% elution, E2= 10% elution, E3= 20% elution, E4= 30% elution, E5= 60% elution.



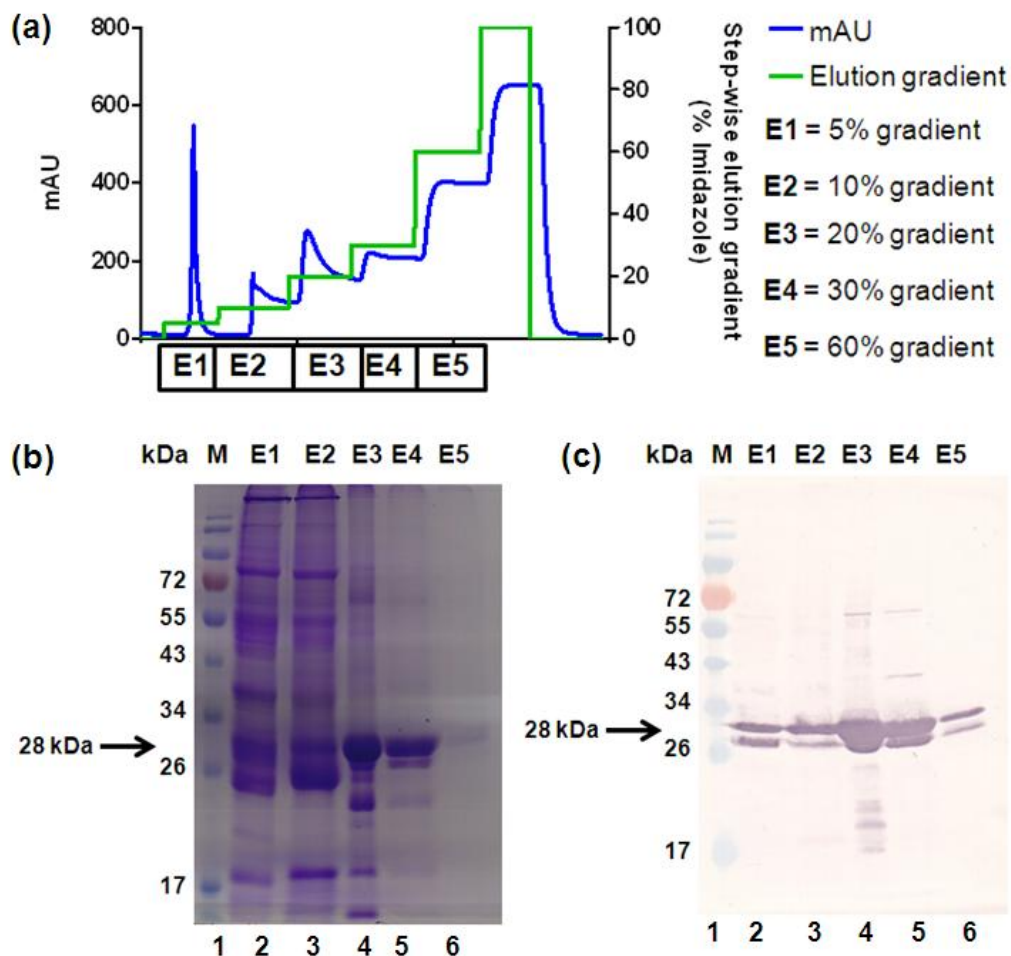
**Figure 3.9:** Purification of the C3.1 scFv using SEC chromatography and analysis by SDS-PAGE and Western blot. (a) A typical chromatograph showing the eluted fractions. (b) SDS-PAGE and (c) western blot analysis of C3.1 scFv after SEC. M = molecular weight ladder (kDa), each lane corresponds to an eluted fraction on the chromatograph in part (a).

Expression of the S100R and B6.1 scFvs was carried out in *E. coli* HB2151 cells. Cultures were grown in LB media and induced with 1 mM IPTG at 24 °C overnight. The culture was centrifuged to pellet the cells and the culture supernatant was 0.2  $\mu$ M sterile filtered. For the initial round of purification of the S100R and B6.1 scFvs, IMAC was used. The scFvs were eluted with imidazole using a stepwise gradient. All eluted fractions were concentrated approximately 30 fold and analysed on a 12% non-reducing gel and by western blot. A typical IMAC chromatography for S100R scFv is shown in panel (a) in Figure 3.10. SDS-PAGE analysis of the S100R scFvs after IMAC shows the approximate molecular weight to be 28 kDa as shown in panel (b) in Figure 3.10 and the theoretical molecular weight is shown in Table 3.1. The scFv was detected by western blot analysis using an anti-His tag antibody as shown in panel (c) in Figure 3.10. A typical IMAC chromatography for B6.1 scFv is shown in panel (a) in Figure 3.11. SDS-PAGE analysis of the B6.1 scFvs after IMAC shows the approximate molecular weight to be 28 kDa as shown in panel (b) in Figure 3.11 and the theoretical molecular weight is shown in Table 3.1. The scFv was detected by western blot analysis using an anti-His tag antibody as shown in panel (c) in Figure 3.11.



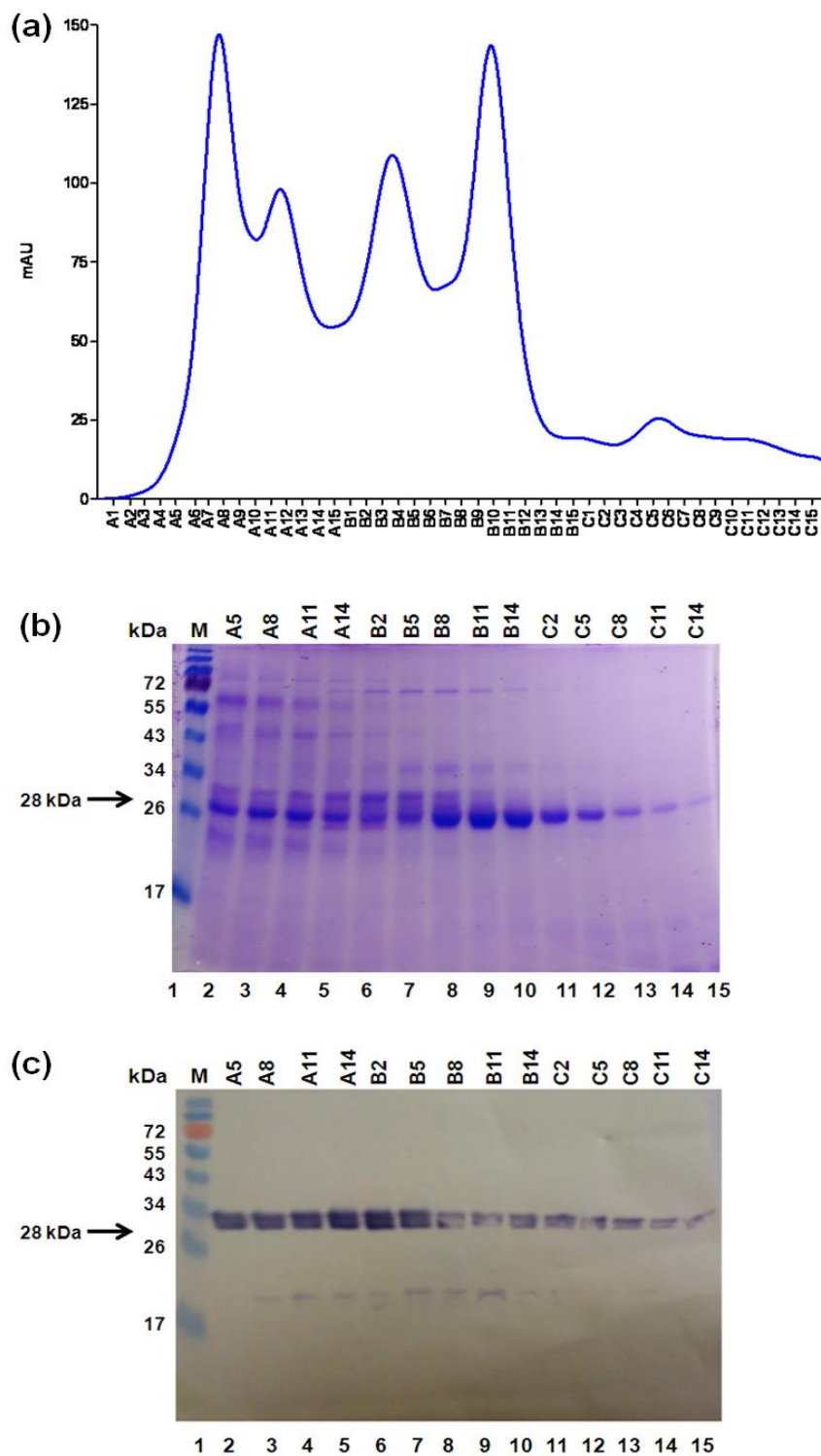
**Figure 3.10:** Purification of the S100R scFv using IMAC chromatography and analysis by SDS-PAGE and Western blot. (a) A typical chromatograph showing the step-wise gradient elution. (b) SDS-PAGE and (c) western blot analysis of S100R scFv after IMAC. M = molecular weight ladder (kDa), E1= 5% elution, E2= 10% elution, E3= 20% elution, E4= 30% elution.



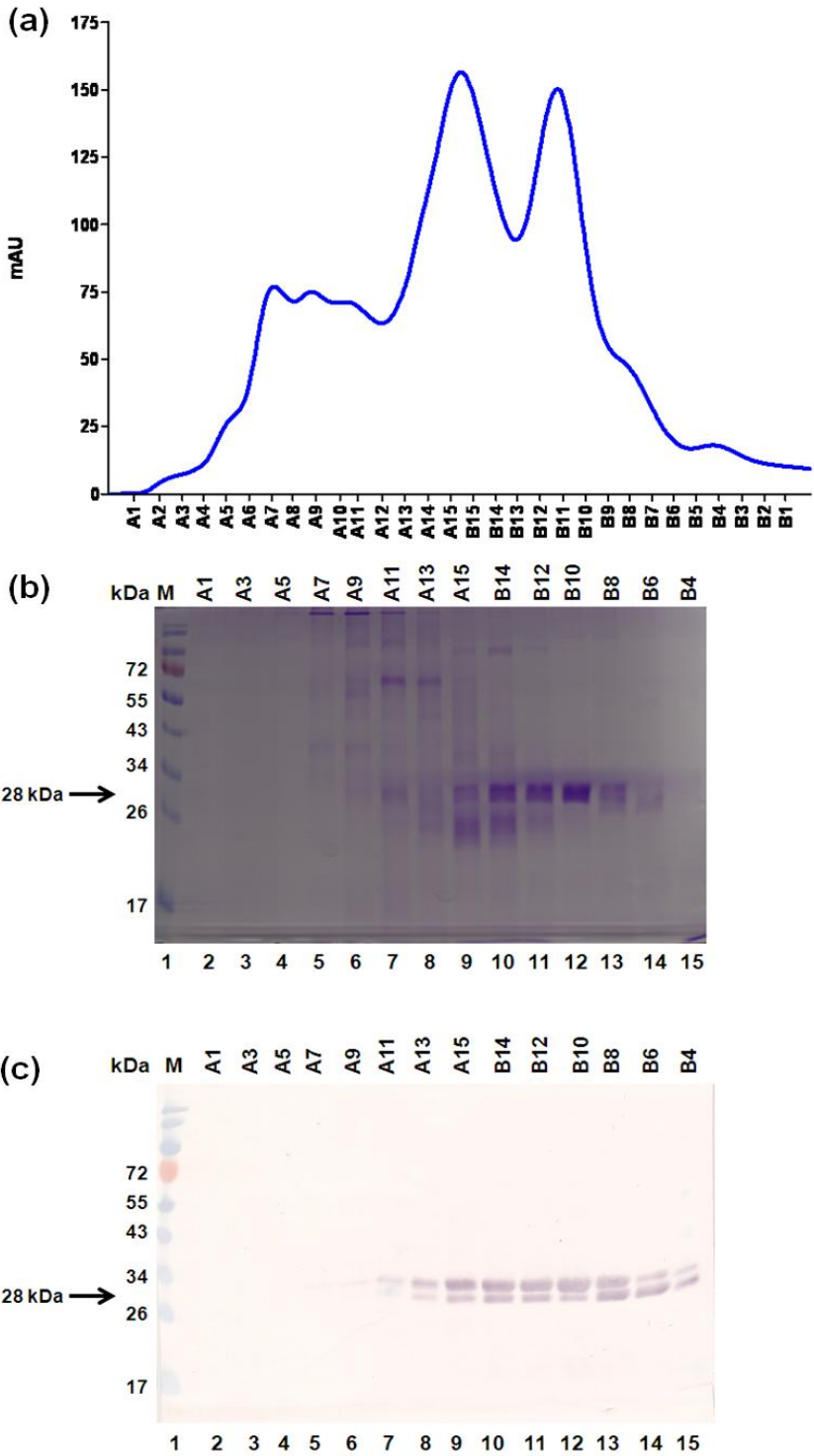


**Figure 3.11:** Purification of the B6.1 scFv using IMAC chromatography and analysis by SDS-PAGE and Western blot. (a) A typical chromatograph showing the step-wise gradient elution. (b) SDS-PAGE and (c) western blot analysis of B6.1 scFv after IMAC. M = molecular weight ladder (kDa), E1= 5% elution, E2= 10% elution, E3= 20% elution, E4= 30% elution, E5= 60% elution.

As a polishing step to further purify the S100R and B6.1 scFvs we used SEC. The IMAC purified scFvs were concentrated to ~ 500  $\mu$ l and were loaded onto a Superdex<sup>TM</sup> 75 10/300 GL column. Both scFvs were found to elute at approximately 13 ml post injection. A typical elution chromatograph for the S100R scFv is shown in panel (a) Figure 3.12 and for the B6.1 scFv in panel (a) in Figure 3.13. Eluted fractions were analysed by non-reducing 12% SDS-PAGE and western blot for the S100R scFv in panels (b) and (c) in Figure 3.12 and for the B6.1 scFv in panels (b) and (c) in Figure 3.13.



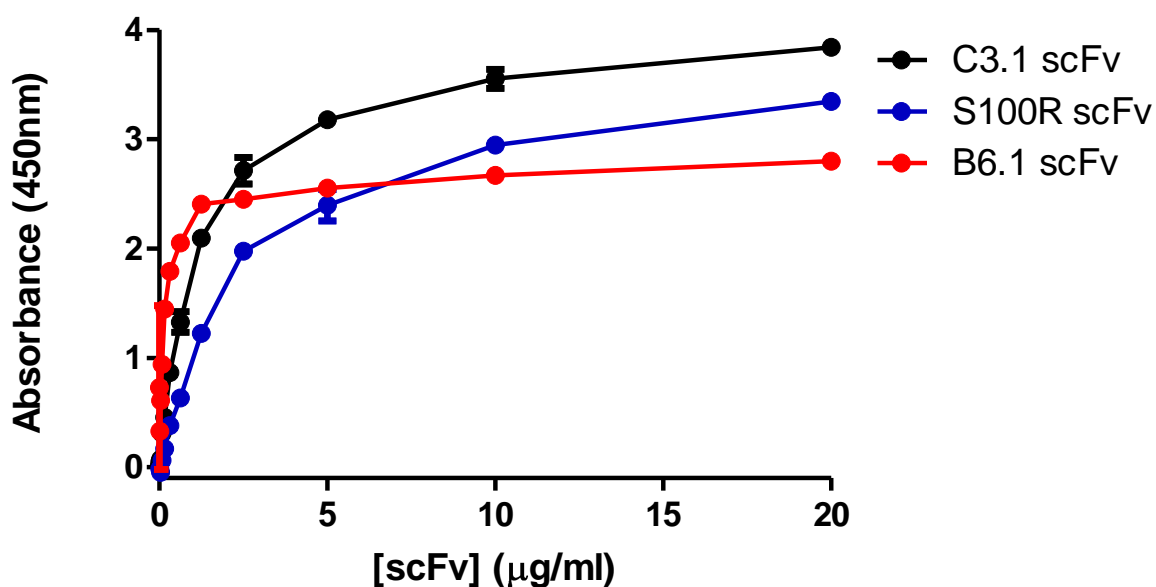
**Figure 3.12:** Purification of the S100R scFv using SEC chromatography and analysis by SDS-PAGE and Western blot. (a) A typical chromatograph showing the eluted fractions. (b) SDS-PAGE and (c) western blot analysis of S100R scFv after SEC. M = molecular weight ladder (kDa), each lane corresponds to an eluted fraction on the chromatograph in part (a) which is highlighted with \*.



**Figure 3.13:** Purification of the B6.1 scFv using SEC chromatography and analysis by SDS-PAGE and Western blot. (a) A typical chromatograph showing the eluted fractions. (b) SDS-PAGE and (c) western blot analysis of B6.1 scFv after SEC. M = molecular weight ladder (kDa), each lane corresponds to an eluted fraction on the chromatograph in part (a).

### 3.2.4 Enzyme linked immunosorbent assay (ELISA)

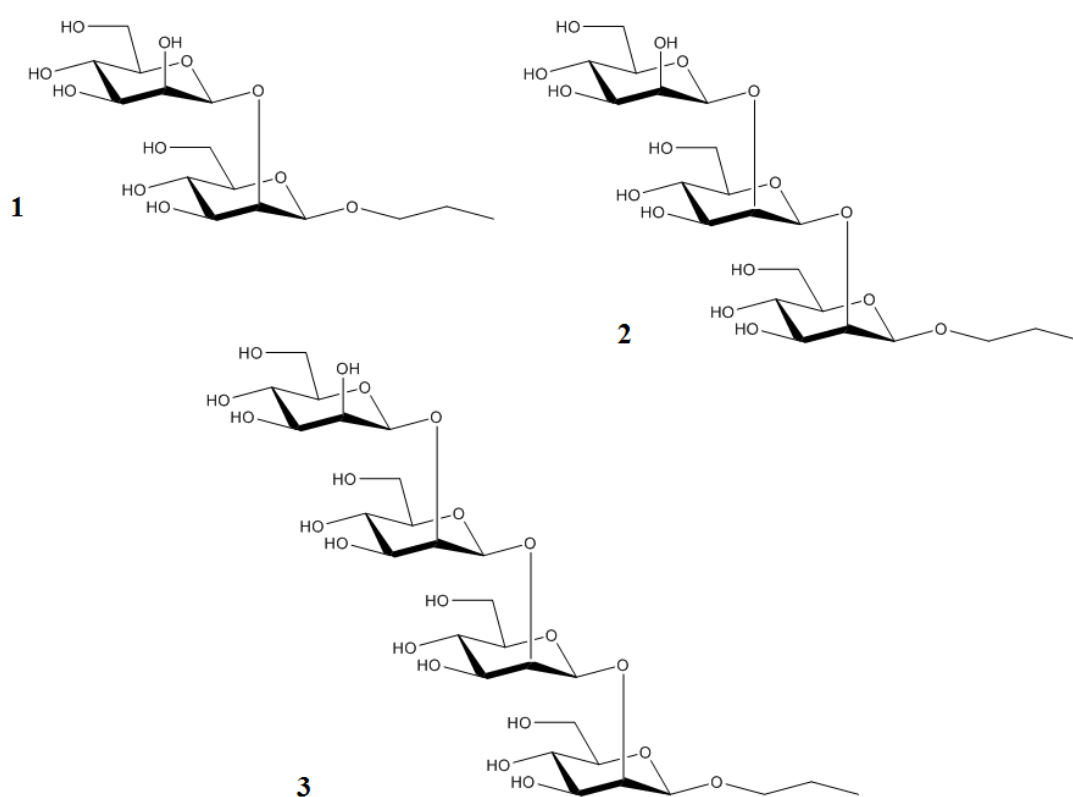
To confirm that the C3.1, S100R and B6.1 scFv were active, we tested them for binding to the cell wall extract from *Candida albicans* (Han et al. 2000), which contains the  $\beta$ -1,2-mannose epitope recognized by the C3.1 IgG3 and B6.1 IgM monoclonal antibodies (Han et al. 2000). Using an indirect ELISA we have shown that the C3.1, S100R and B6.1 scFv binds to the *C. albicans* cell wall extract as shown in Figure 3.14.



**Figure 3.14:** Binding of the C3.1, S100R and B6.1 scFvs to the *Candida albicans* cell-wall epitope.

### 3.2.5 Surface plasmon resonance studies

The C3.1 IgG3 has been reported to have a higher affinity for di- (5-fold higher) and trisaccharide (2-fold higher) antigens compared to the B6.1 IgM (Nitz et al. 2002), while its affinity for the tetradsaccharide is similar to that of the B6.1 IgM, with an affinity approximately 1.3-fold higher (Nitz et al. 2002). To confirm whether the S100R and B6.1 scFvs showed similar trends for the mannosides 1 – 3 shown in Figure 3.15, SPR experiments were performed.



**Figure 3.15:**  $\beta$ -1,2-linked mannosides; (1) disaccharide, (2) trisaccharide and (3) tetrasaccharide.

Affinities for the C3.1 scFv determined by SPR were reported by Johnson *et al.* (Johnson et al. 2012) and had a similar trend to those reported for the C3.1 IgG by ELISA (Nitz et al. 2002), with the C3.1 scFv showing a stronger affinity for the smaller di- and trisaccharide over the larger tetrasaccharide as shown in Table 3.2.

Dissociation constants for the S100R scFv with the oligosaccharides were determined using a Biacore X-100 SPR instrument. The S100R scFv was immobilised on a dextran coated chip that was activated with EDC/NHS. Subsequently, remaining sites were blocked with ethanolamine. Oligosaccharides were injected over the chip in 1X HBSN buffer and association and dissociation curves measured. The binding curves and fits for the S100R mutant with the di-, tri- and tetrasaccharide are shown in Figure 3.16, 3.17 and 3.18 respectively, and the data summarized in Table 3.2.

Due to limited amounts of the saccharides, it was only possible to test the B6.1 scFv for binding to the trisaccharide. This was done using a Reichert SR7500DC SPR instrument. As in the case of S100R, a dextran chip was activated with EDC/NHS, after which the B6.1 scFv was immobilised. Any remaining sites were blocked with ethanolamine. The trisaccharide was injected over the chip in HBSN buffer to obtain association and dissociation curves. The binding curve and fit for the B6.1 scFv are represented in Figure 3.19, and the data is included in Table 3.2.

**Table 3.2:** Comparison of ELISA  $IC_{50}$  values (Nitz et al. 2002)<sup>\*</sup>, and our SPR  $K_D$  values with the C3.1 scFv (Johnson et al. 2012)<sup>\*\*</sup>, S100R scFv<sup>\*\*</sup> and B6.1 scFv<sup>\*\*</sup> Abs for binding to the di-, tri- and tetrasaccharides.

<b><math>\beta</math>-1,2-linked mannosides</b>	<b>C3.1 (IgG3)<sup>*</sup></b>	<b>B6.1 (IgM)<sup>*</sup></b>	<b>C3.1 scFv<sup>**</sup></b>	<b>S100R scFv<sup>**</sup></b>	<b>B6.1 scFv<sup>**</sup></b>
<b>Disaccharide</b>	8 $\mu$ M	44 $\mu$ M	26.7 $\pm$ 0.2 $\mu$ M	87.1 $\pm$ 0.9 $\mu$ M	-
<b>Trisaccharide</b>	16 $\mu$ M	38 $\mu$ M	18.0 $\pm$ 0.3 $\mu$ M	23.4 $\pm$ 0.3 $\mu$ M	18.9 $\pm$ 3 $\mu$ M
<b>Tetrasaccharide</b>	84 $\mu$ M	108 $\mu$ M	87.7 $\pm$ 0.3 $\mu$ M	59.1 $\pm$ 0.6 $\mu$ M	-

<sup>\*</sup>ELISA  $IC_{50}$  values

<sup>\*\*</sup>SPR  $K_D$  values

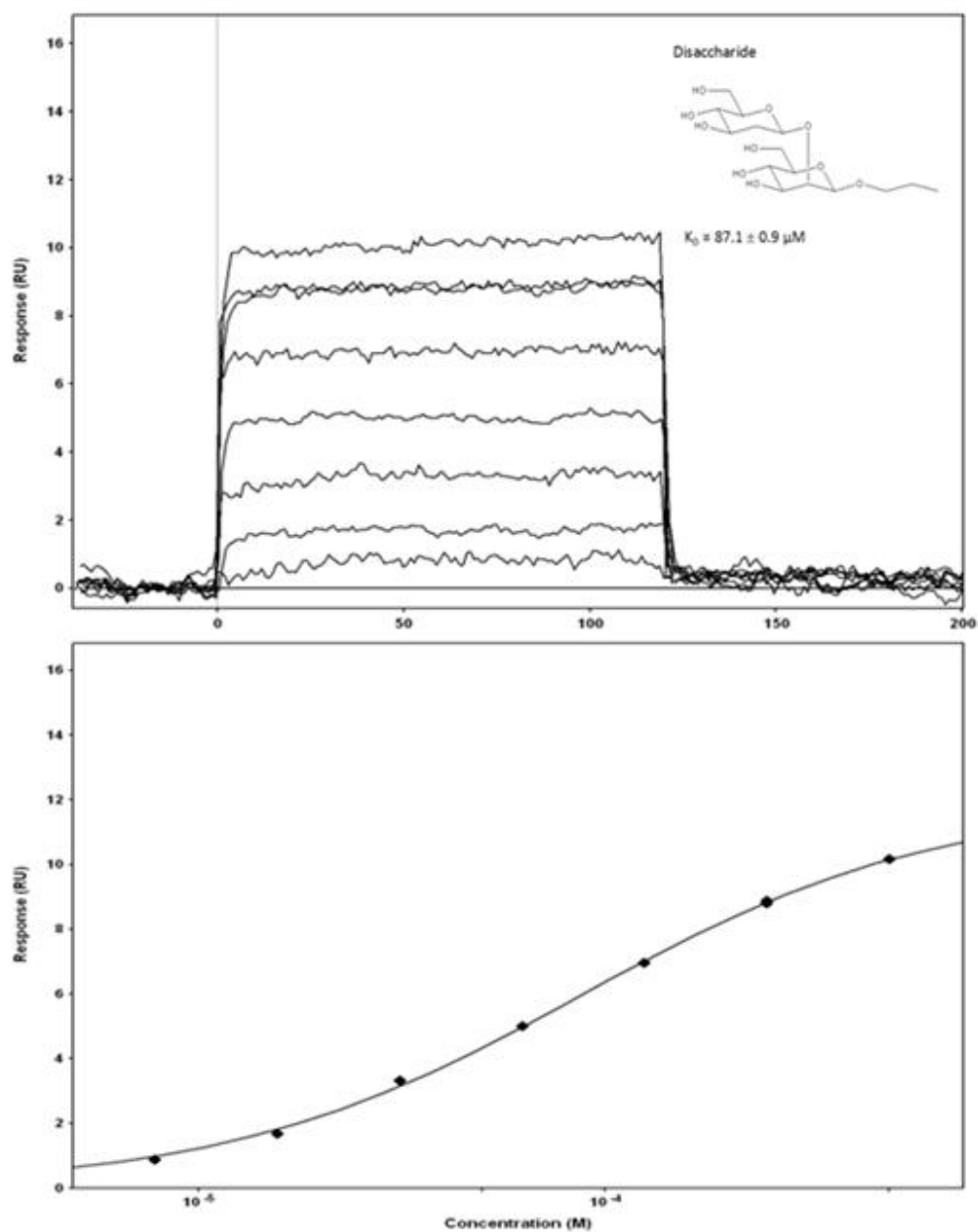
Mutant S100R had a lower affinity for the disaccharide in comparison to the tri- and tetrasaccharide. It had its strongest affinity for the trisaccharide, a trend which was similar to the B6.1 IgM that also had a higher affinity for the trisaccharide over the di- or tetrasaccharide (Nitz et al. 2002). This suggests that the introduction of the mutations in the S100R scFv reduced the affinity of the scFv for the smaller disaccharide while having a stronger affinity for the larger tri- and tetrasaccharide.

The affinity of the B6.1 scFv for the trisaccharide was almost equal to the affinity of the C3.1 scFv for the trisaccharide which were both similar to the reported affinity of the C3.1 IgG for the trisaccharide. In comparison to the B6.1 IgM, the B6.1 scFv had a 2-fold higher affinity for the trisaccharide. Due to limited saccharides it was not possible to test the disaccharide and tetrasaccharide.

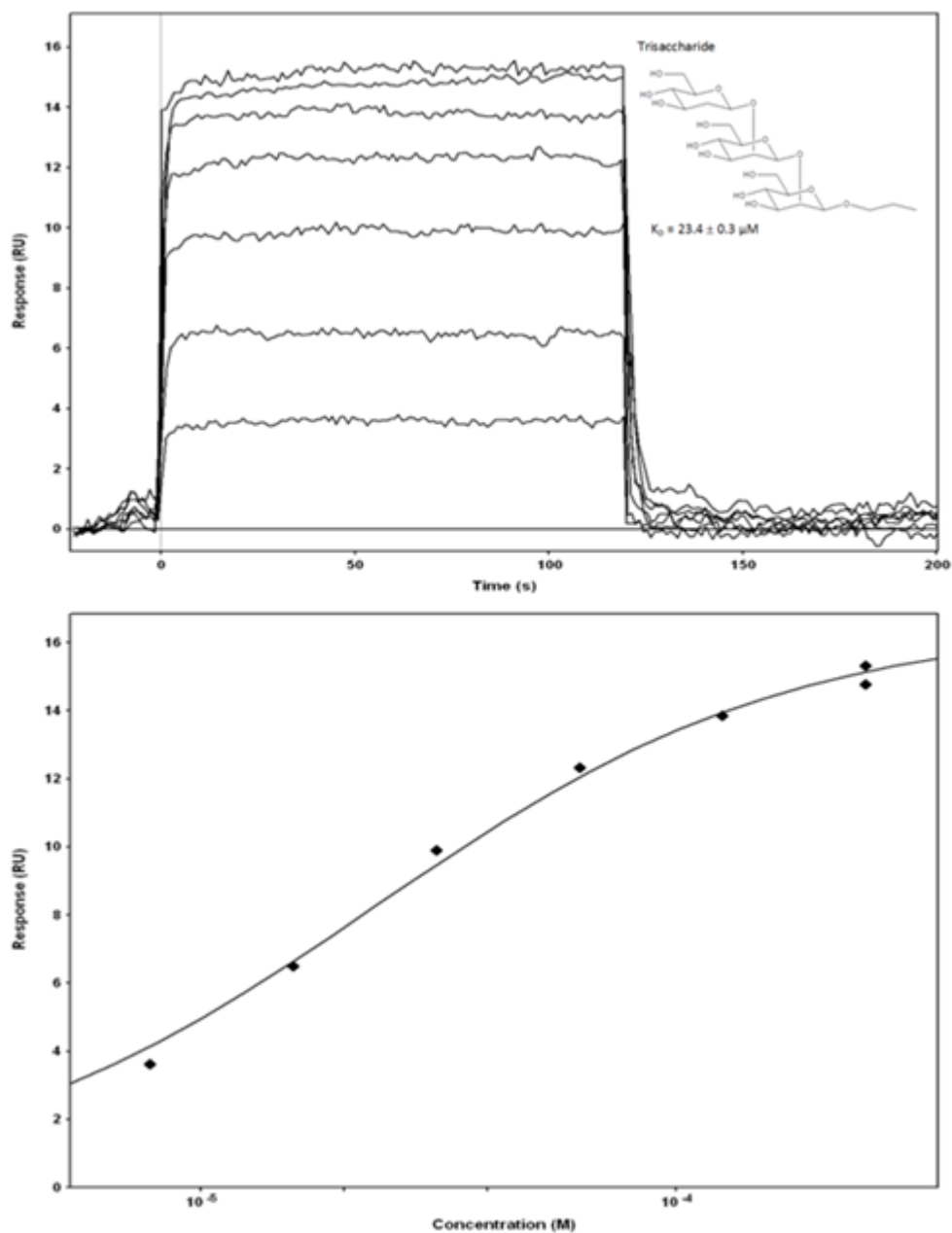
The C3.1 scFv differs from the S100R scFv and B6.1 scFv by only 6 amino acid residues in the variable heavy region. It is interesting to note that of the six amino acid residues only two are present in the complementary determining regions (CDRs), with the N56D and T60A mutations present in CDR2 as shown in Figure 3.20. The CDRs have the greatest level of variability in their sequence and are responsible for antigen recognition, in particular CDR2 and CDR3 which contribute 23% and 29%, respectively, to the overall antigen binding (Weisser & Hall 2009; Wilson & Stanfield 1994). The S100R mutation is near the end of FWR3 in the heavy region, close to the CDR3. This proximity of this mutation to CDR3 may help to explain its contribution to the binding properties displayed by the S100R mutant scFv.

Currently we have not any data for the point mutants described in Appendix II, due to limited time for the expression and purification of the scFvs and limited saccharides for SPR studies.

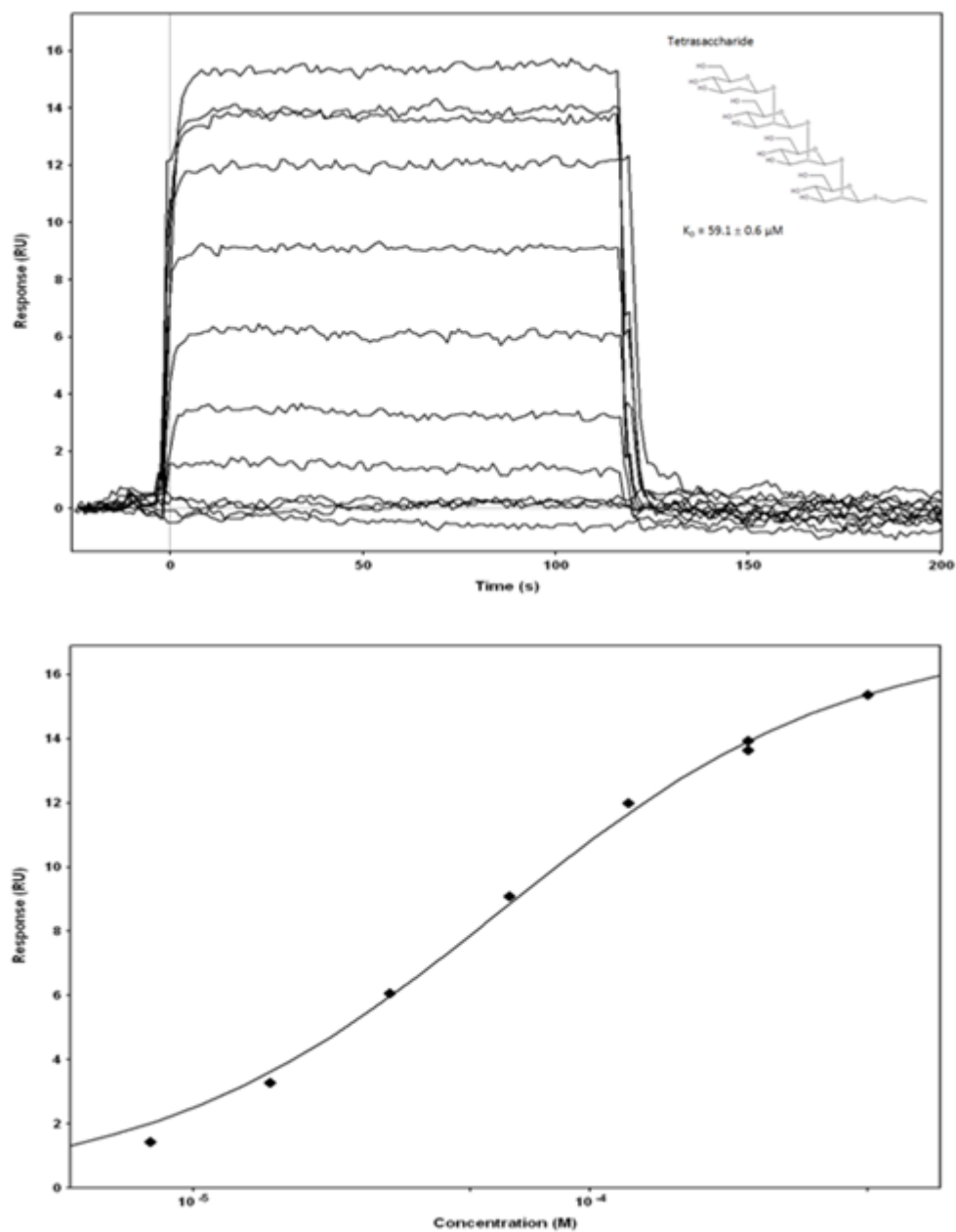




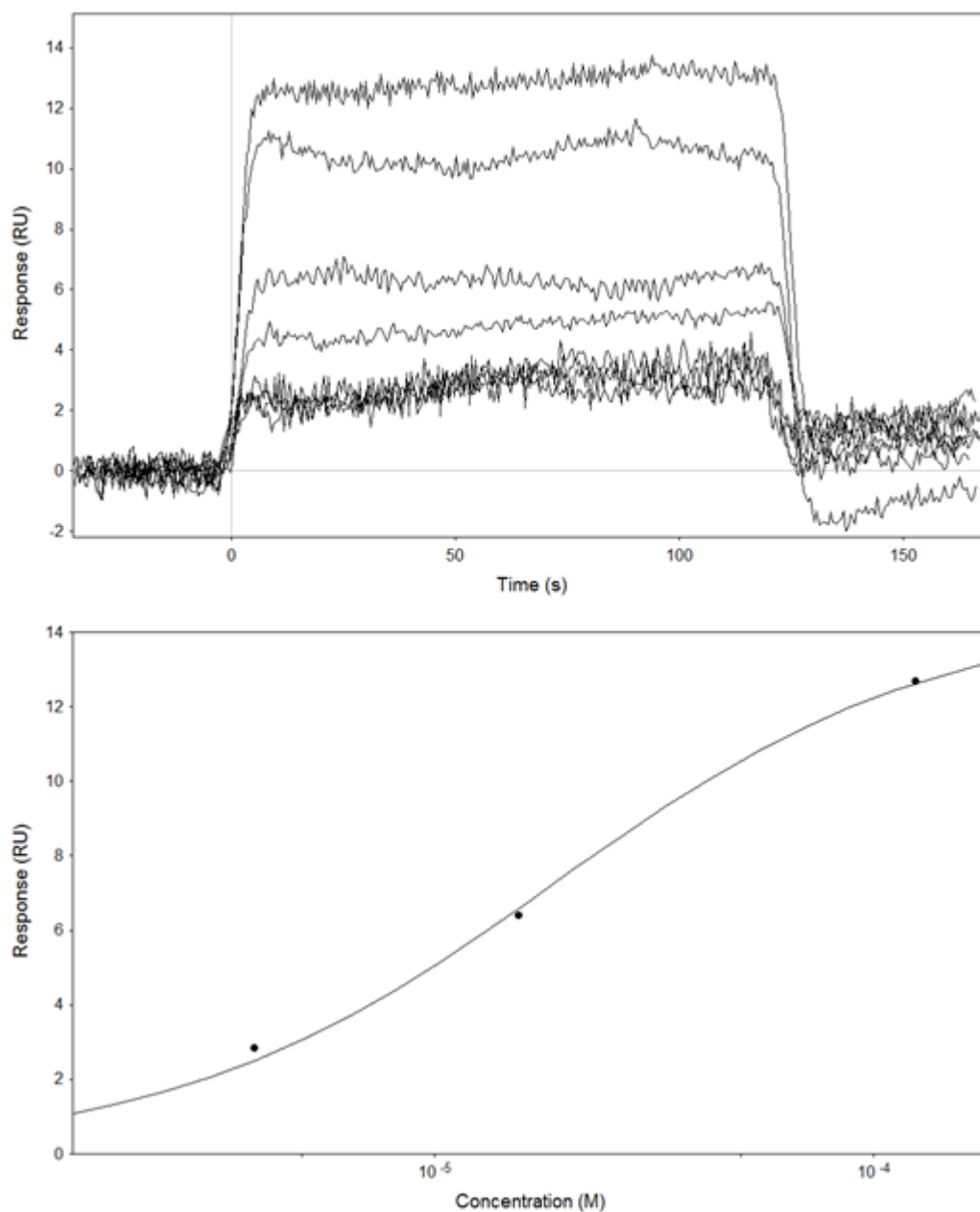
**Figure 3.16:** Surface plasmon resonance of S100R scFv binding to Disaccharide ( $K_D = 87.1 \pm 0.9 \mu\text{M}$ ) at equilibrium. Representative sensograms (top panels) and fits of the response at equilibrium (bottom panels) from the SPR binding assays



**Figure 3.17:** Surface plasmon resonance of S100R scFv binding to Trisaccharide ( $K_D = 23.4 \pm 0.3 \mu\text{M}$ ) at equilibrium. Representative sensograms (top panels) and fits of the response at equilibrium (bottom panels) from the SPR binding assays



**Figure 3.18:** Surface plasmon resonance of S100R scFv binding to Tetrasaccharide ( $K_D = 59.1 \pm 0.6 \mu\text{M}$ ) at equilibrium. Representative sensograms (top panels) and fits of the response at equilibrium (bottom panels) from the SPR binding assays



**Figure 3.19:** Surface plasmon resonance of B6.1 scFv binding to trisaccharide ( $K_D = 18.9 \pm 3 \mu\text{M}$ ) at equilibrium. Representative sensograms (top panels) and fits of the response at equilibrium (bottom panels) from the SPR binding assays



**Figure 3.20:** Sequence alignment of the C3.1, S100R and B6.1 scFvs showing the framework regions (FWR) and complementary determining regions (CDR). The mutations in the variable heavy chain are outlined in red.

### 3.3 Conclusions and Future Work

#### 3.3.1 Conclusions

C3.1, B6.1 and S100R scFvs based on the variable heavy and light chains of the C3.1 IgG3 and B6.1 IgM antibodies have been cloned, expressed, purified and their binding preferences examined. The C3.1 IgG3 and B6.1 IgM, which recognise the same  $\beta$ -1,2-mannan epitope, have been shown to have a stronger affinity for smaller di- and trisaccharides in comparison to the larger tetra- to hexasaccharides (Nitz et al. 2002). This is in contrast to the normal pattern where the affinity of an antibody for a saccharide increases with increasing oligosaccharide size (Kabat 1966). The C3.1 scFv was used as template to generate the S100R and B6.1 scFvs via a series of site-directed mutagenesis reactions. All the scFvs were expressed as soluble protein in the culture supernatant and were isolated via IMAC and SEC.

ELISA assays were used to determine that all three scFvs bound to the cell wall extract of *C. albicans*, before subsequent SPR studies were performed. Previous reports have shown the higher affinity of the C3.1 IgG3, B6.1 IgM (Nitz et al. 2002) and C3.1 scFvs (Johnson et al. 2012) for the smaller di- and trisaccharides, via ELISA and SPR respectively. The S100R scFv had its strongest affinity for the tri- and tetrasaccharide, and its lowest affinity for the disaccharide. The S100R scFv mutation appeared to favour the slightly larger tri- and tetrasaccharide over the disaccharide. Interestingly, the S100R mutation was present in the variable heavy, FWR3 region, which is generally considered as a scaffold region, and not involved as much in antigen binding. This residue however is close to the variable heavy, CDR3 region, which contribute the most to antigen binding (Wilson & Stanfield 1994). The B6.1 scFv showed a similar trend to the C3.1 scFv and S100R scFv in having a strong affinity for the trisaccharide, although it was not possible to test it with the di- or tetrasaccharide. Unlike the B6.1 IgM which had a 2-fold lower affinity for the trisaccharide in comparison to the C3.1 IgG3, both the B6.1 scFv and C3.1 scFvs had similar affinities for the trisaccharide,  $18.9 \pm 3.0 \mu\text{M}$  and  $18.0 \pm 0.3 \mu\text{M}$  respectively.

### 3.3.2 Future Work

As the scFvs are all present as double bands on SDS-PAGE gels, as well as detection of both bands on western blots with both an anti-His and anti-myc tag antibodies, it would be interesting to study the reason for this. All SDS-PAGE analysis was carried out on 12% non-reducing gels, so to determine if the scFvs are folded correctly could be determined by running a reducing SDS-PAGE gel. If this resulted in a single band on the gel, it would be suggestive of incorrectly folded protein. However, if both bands were still present in a reducing gel, it would indicate that there was an alternative reason for the presence of the two bands. As the scFvs all elute from the size exclusion column at a volume in agreement with the presence of monomeric scFvs, there may be a different reason for the double bands observed. The scFvs were found in the culture supernatant and this has been observed in *E. coli* HB2151 cells when induction is carried out for prolonged periods. This lengthy induction period may cause the cells to be under stress and weaken the cell membrane, resulting in the scFv proteins produced to leak from the cells before cleavage of the pelB leader sequence. The pelB leader sequence is approximately 2000 Da and based on the molecular weights of the bands observed on the SDS-PAGE gels, could account for the difference in the two bands if the proteins are folded correctly. To determine if the pelB leader sequence was present, analysis could be carried out by mass spectrometry to sequence the proteins. We are also interested in studying the interactions between the different subclone point mutations and the di-, tri- and tetrasaccharides, to determine which mutations are necessary for binding to smaller saccharides, as well as to quantify the contributions from residues associated with maturation of the IgM (B6.1) to IgG (C3.1). In particular it would be interesting to determine how the N56D and T60A mutations would change the binding affinities as these are the only residues present in a complementary determining region. The other four amino acid mutations Q5K, S79T, V81I and A90V are all present in the framework regions 1 and 3, and normally these are considered scaffold regions, which display the CDRs for antigen binding but have no role in antigen binding.

## References

- A. Varki; J.B. Lowe, 2009. Biological Roles of Glycans. In A. Varki et al., eds. *Essentials of Glycobiology*. Cold Spring Harbor (NY): Cold Spring Harbor Laboratory Press, pp. 75 – 88. Available at: <http://www.ncbi.nlm.nih.gov/books/NBK1897/>.
- Abd Hamid, U.M. et al., 2008. A strategy to reveal potential glycan markers from serum glycoproteins associated with breast cancer progression. *Glycobiology*, 18(12), pp.1105–1118. Available at: <http://www.ncbi.nlm.nih.gov/pubmed/18818422>.
- Altenbuchner, J.; Mattes, R., 2006. Escherichia coli. In G. Gellissen, ed. *Production of recombinant proteins: novel microbial and eukaryotic expression systems*. Wiley-VCH, pp. 7 – 43. Available at: <https://www.dawsonera.com:443/abstract/9783527604418>.
- Angata, T., 2002. I-type lectins. *Biochimica et Biophysica Acta (BBA) - General Subjects*, 1572(2-3), pp.294–316. Available at: <http://www.sciencedirect.com/science/article/pii/S0304416502003161> [Accessed February 15, 2014].
- Antachopoulos, C., Walsh, T.J. & Roilides, E., 2007. Fungal infections in primary immunodeficiencies. *European Journal of Pediatrics*, 166(11), pp.1099–117. Available at: <http://www.ncbi.nlm.nih.gov/pubmed/17551753>.
- Arnold, J.N. et al., 2011. Novel glycan biomarkers for the detection of lung cancer. *Journal of Proteome Research*, 10(4), pp.1755–1764. Available at: <http://www.ncbi.nlm.nih.gov/pubmed/21214223>.
- Artimo, P. et al., 2012. ExpASy: SIB bioinformatics resource portal. *Nucleic Acids Research*, 40 (W1), pp.W597–W603. Available at: <http://nar.oxfordjournals.org/content/40/W1/W597.abstract>.
- Ashida, H. et al., 2009. Two distinct alpha-L-fucosidases from Bifidobacterium bifidum are essential for the utilization of fucosylated milk oligosaccharides and glycoconjugates. *Glycobiology*, 19(9), pp.1010–1017. Available at: <http://ovidsp.ovid.com/ovidweb.cgi?T=JS&NEWS=N&PAGE=fulltext&AN=0002513-200909000-00012&D=ovftj>.
- Beck-Sauge, C.M. & Jarvis, W.R., 1993. Secular trends in the epidemiology of nosocomial fungal infections in the United States 1980-1990. *Journal of Infectious Disease*, 167, pp.1247–1251.
- Berlec, A. & Štrukelj, B., 2013. Current state and recent advances in biopharmaceutical production in Escherichia coli, yeasts and mammalian cells. *Journal of Industrial Microbiology & Biotechnology*, 40(3-4), pp.257–274. Available at: <http://dx.doi.org/10.1007/s10295-013-1235-0>.



- De Bernardez Clark, E., 1998. Refolding of recombinant proteins. *Current Opinion in Biotechnology*, 9(2), pp.157–163. Available at: <http://www.sciencedirect.com/science/article/pii/S0958166998801092>.
- Bhaskaran, S. et al., 2005. A Single-chain Fragment Variable Recombinant Antibody against F5 Fimbria of Enterotoxigenic Escherichia coli Inhibits Agglutination of Horse Red Blood Cells Induced by F5 Protein. *Veterinary Research Communications*, 29(6), pp.463–476 LA – English. Available at: <http://dx.doi.org/10.1007/s11259-005-1432-z>.
- Bird, R.E. et al., 1988. Single-chain antigen-binding proteins. *Science*, 242 (4877), pp.423–426. Available at: <http://www.sciencemag.org/content/242/4877/423.abstract>.
- Blixt, O. et al., 2004. Printed covalent glycan array for ligand profiling of diverse glycan binding proteins. *Proceedings of the National Academy of Sciences of the United States of America*, 101 (49), pp.17033–17038. Available at: <http://www.pnas.org/content/101/49/17033.abstract>.
- De Boer, H.A., Comstock, L.J. & Vasser, M., 1983. The tac promoter: a functional hybrid derived from the trp and lac promoters. *Proceedings of the National Academy of Sciences*, 80 (1), pp.21–25. Available at: <http://www.pnas.org/content/80/1/21.abstract>.
- Bolanos-Garcia, V.M. & Davies, O.R., 2006. Structural analysis and classification of native proteins from E. coli commonly co-purified by immobilised metal affinity chromatography. *Biochimica et Biophysica Acta (BBA) - General Subjects*, 1760(9), pp.1304–1313. Available at: <http://www.sciencedirect.com/science/article/pii/S0304416506000894>.
- Boren, T. et al., 1993. Attachment of Helicobacter pylori to human gastric epithelium mediated by blood group antigens. *Science*, 262 (5141), pp.1892–1895. Available at: <http://www.sciencemag.org/content/262/5141/1892.abstract>.
- Brazil, J.C. et al., 2013.  $\alpha$ 3/4 Fucosyltransferase 3-Dependent Synthesis of Sialyl Lewis A on CD44 Variant Containing Exon 6 Mediates Polymorphonuclear Leukocyte Detachment from Intestinal Epithelium during Transepithelial Migration. *The Journal of Immunology*. Available at: <http://www.jimmunol.org/content/early/2013/09/25/jimmunol.1301307.abstract>.
- Brosius, J., Erfle, M. & Storella, J., 1985. Spacing of the -10 and -35 regions in the tac promoter. Effect on its in vivo activity. *Journal of Biological Chemistry*, 260 (6), pp.3539–3541. Available at: <http://www.jbc.org/content/260/6/3539.abstract>.
- Burgess-Brown, N.A. et al., 2008. Codon optimization can improve expression of human genes in Escherichia coli: A multi-gene study. *Protein expression and purification*, 59(1), pp.94–102. Available at: <http://www.sciencedirect.com/science/article/pii/S104659280800020X> [Accessed January 21, 2014].

- Cao, L. et al., 2006. Characterization of a single-chain variable fragment (scFv) antibody directed against the human asialoglycoprotein receptor. *Biotechnology and applied Biochemistry*, 44(Pt 2), pp.65–72. Available at: <http://www.babonline.org/bab/044/bab0440065.htm>.
- Cazet, A. et al., 2010. Tumour-associated carbohydrate antigens in breast cancer. *Breast cancer research*: BCR, 12(3), p.204. Available at: <http://breast-cancer-research.com/content/12/3/204> [Accessed October 20, 2013].
- Celik, E. & Calik, P., 2012. Production of recombinant proteins by yeast cells. *Biotechnology advances*, 30(5), pp.1108–18. Available at: <http://www.sciencedirect.com/science/article/pii/S0734975011001649> [Accessed January 23, 2014].
- Chen, R., 2012. Bacterial expression systems for recombinant protein production: E. coli and beyond. *Biotechnology advances*, 30(5), pp.1102–7. Available at: <http://www.sciencedirect.com/science/article/pii/S0734975011001662> [Accessed January 20, 2014].
- Chen, Y., 2004. A modified osmotic shock for periplasmic release of a recombinant creatinase from Escherichia coli. *Biochemical Engineering Journal*, 19(3), pp.211–215. Available at: <http://linkinghub.elsevier.com/retrieve/pii/S1369703X04000580>.
- Choi, J.H. & Lee, S.Y., 2004. Secretory and extracellular production of recombinant proteins using Escherichia coli. *Applied Microbiology & Biotechnology*, 64(5), pp.625–635. Available at: 10.1007/s00253-004-1559-9.
- Chung, C.T., Niemela, S.L. & Miller, R.H., 1989. One-step preparation of competent Escherichia coli: transformation and storage of bacterial cells in the same solution. *Proceedings of the National Academy of Sciences of the United States of America*, 86(7), pp.2172–5. Available at: <http://www.pubmedcentral.nih.gov/articlerender.fcgi?artid=286873&tool=pmcentrez&rendertype=abstract>.
- Cooper, M.A. et al., 1998. Surface plasmon resonance analysis at a supported lipid monolayer. *Biochimica et Biophysica Acta (BBA) - Biomembranes*, 1373(1), pp.101–111. Available at: <http://www.sciencedirect.com/science/article/pii/S0005273698000911> [Accessed February 12, 2014].
- Coutinho, P.M. et al., 2003. An Evolving Hierarchical Family Classification for Glycosyltransferases. *Journal of Molecular Biology*, 328(2), pp.307–317. Available at: <http://www.sciencedirect.com/science/article/pii/S0022283603003073> [Accessed January 21, 2014].
- Cragg, H. et al., 1997. Fucosidosis: genetic and biochemical analysis of eight cases. *Journal of Medical Genetics*, 34(2), pp.105–110. Available at: <http://jmg.bmj.com/content/34/2/105.abstract>.

- Croce, M. et al., 2007. Lewis x is highly expressed in normal tissues: A comparative immunohistochemical study and literature revision. *Pathology & Oncology Research*, 13(2), pp.130–138. Available at: <http://dx.doi.org/10.1007/BF02893488>.
- Crowther, J.R., 2009. Stages in ELISA. In *The ELISA Guidebook*. Humana Press, pp. 43 – 78.
- Cummings, R.D. & Etzler, M.E., 2009. Antibodies and Lectins in Glycan Analysis. In A. Varki et al., eds. *Essentials of Glycobiology*. Cold Spring Harbor Laboratory Press, pp. 633 – 647.
- Cummings, R.D. & Etzler, M.E., 2009. R-type Lectins. In A. Varki et al., eds. *Essentials of Glycobiology*. Cold Spring Harbor Laboratory Press, pp. 403 – 414.
- Cummings, R.D. & McEver, R.P., 2009. C-type Lectins. In A. Varki et al., eds. *Essentials of Glycobiology*. Cold Spring Harbor (NY): Cold Spring Harbor Laboratory Press. Available at: <http://www.ncbi.nlm.nih.gov/books/NBK1943/>.
- Dahms, N., 2002. P-type lectins. *Biochimica et Biophysica Acta (BBA) - General Subjects*, 1572(2-3), pp.317–340. Available at: <http://www.sciencedirect.com/science/article/pii/S0304416502003173> [Accessed February 15, 2014].
- Dam, T.K. et al., 2005. Galectins Bind to the Multivalent Glycoprotein Asialofetuin with Enhanced Affinities and a Gradient of Decreasing Binding Constants†. *Biochemistry*, 44(37), pp.12564–12571. Available at: <http://dx.doi.org/10.1021/bi051144z>.
- Davies, G. & Henrissat, B., 1995. Structures and mechanisms of glycosyl hydrolases. *Structure*, 3(9), pp.853–859. Available at: <http://www.sciencedirect.com/science/article/pii/S0969212601002209> [Accessed February 17, 2014].
- Day, H.N.D. and B.W., 2010. Theory and Applications of Surface Plasmon Resonance, Resonant Mirror, Resonant Waveguide Grating, and Dual Polarization Interferometry Biosensors. *Sensors (14248220)*, 10(11), pp.9630–9646. Available at: <http://search.ebscohost.com/login.aspx?direct=true&db=a9h&AN=57951181&site=ehost-live>.
- Drickamer, K., 1988. Two distinct classes of carbohydrate-recognition domains in animal lectins. *Journal of Biological Chemistry*, 263 (20), pp.9557–9560. Available at: <http://www.jbc.org/content/263/20/9557.short>.
- Drugmand, J.-C., Schneider, Y.-J. & Agathos, S.N., 2012. Insect cells as factories for biomanufacturing. *Biotechnology advances*, 30(5), pp.1140–57. Available at: <http://www.sciencedirect.com/science/article/pii/S0734975011001790> [Accessed January 21, 2014].

- Einhauer, A. & Jungbauer, A., 2001. The FLAG<sup>TM</sup> peptide, a versatile fusion tag for the purification of recombinant proteins. *Journal of Biochemical and Biophysical Methods*, 49(1-3), pp.455–465. Available at: <http://www.sciencedirect.com/science/article/pii/S0165022X01002135> [Accessed February 17, 2014].
- Engvall, E. & Perlmann, P., 1971. Enzyme-linked immunosorbent assay (ELISA) quantitative assay of immunoglobulin G. *Immunochemistry*, 8(9), pp.871–874. Available at: <http://www.sciencedirect.com/science/article/pii/001927917190454X>.
- Esposito, D. & Chatterjee, D.K., 2006. Enhancement of soluble protein expression through the use of fusion tags. *Current Opinion in Biotechnology*, 17(4), pp.353–358. Available at: <http://www.sciencedirect.com/science/article/pii/S0958166906000875>.
- Etzler, M.E., Surolia, A. & Cummings, R.D., 2009. L-type Lectins. In A. Varki et al., eds. *Essentials of Glycobiology*. Cold Spring Harbor Laboratory Press, Cold Spring Harbor (NY), pp. 415 – 424.
- Feizi, T., 2003. Carbohydrate microarrays — a new set of technologies at the frontiers of glycomics. *Current Opinion in Structural Biology*, 13(5), pp.637–645. Available at: <http://www.sciencedirect.com/science/article/pii/S0959440X03001350> [Accessed February 10, 2014].
- Feizi, T. & Chai, W., 2004. Oligosaccharide microarrays to decipher the glyco code. *Nature reviews. Molecular cell biology*, 5(7), pp.582–588.
- Fox, J.D. & Waugh, D.S., 2003. Maltose-binding protein as a solubility enhancer. *Methods In Molecular Biology Clifton Nj*, 205, pp.99–117. Available at: <http://www.ncbi.nlm.nih.gov/pubmed/12491882>.
- Francis, D.M. & Page, R., 2001. Strategies to Optimize Protein Expression in E. coli. In *Current Protocols in Protein Science*. John Wiley & Sons, Inc. Available at: <http://dx.doi.org/10.1002/0471140864.ps0524s61>.
- Fukui, S. et al., 2002. Oligosaccharide microarrays for high-throughput detection and specificity assignments of carbohydrate-protein interactions. *Nature biotechnology*, 20(10), pp.1011–1017.
- Ghazarian, H., Idoni, B. & Oppenheimer, S.B., 2011. A glycobiology review: carbohydrates, lectins and implications in cancer therapeutics. *Acta histochemica*, 113(3), pp.236–247. Available at: <http://europepmc.org/abstract/MED/20199800>.
- Glynou, K., Ioannou, P.C. & Christopoulos, T.K., 2003. One-step purification and refolding of recombinant photoprotein aequorin by immobilized metal-ion affinity chromatography. *Protein Expression and Purification*, 27(2), pp.384–

390. Available at: <http://www.scopus.com/inward/record.url?eid=2-s2.0-0037297123&partnerID=40&md5=1616e92cd1ada75dd71ebef6fa202c77>.
- Goldberg, S., 2008. Mechanical/Physical Methods of Cell Disruption and Tissue Homogenization. In A. Posch, ed. *2D PAGE: Sample Preparation and Fractionation SE - 1*. Methods in Molecular Biology<sup>TM</sup>. Humana Press, pp. 3–22. Available at: [http://dx.doi.org/10.1007/978-1-60327-064-9\\_1](http://dx.doi.org/10.1007/978-1-60327-064-9_1).
- Gopal, G. & Kumar, A., 2013. Strategies for the Production of Recombinant Protein in Escherichia coli. *The Protein Journal*, 32(6), pp.419–425. Available at: <http://dx.doi.org/10.1007/s10930-013-9502-5>.
- Gottesman, S., 1990. *Gene Expression Technology*, Elsevier. Available at: <http://www.sciencedirect.com/science/article/pii/007668799085013E> [Accessed February 16, 2014].
- Gottesman, S., 1989. Genetics of Proteolysis in Escherichia Coli. *Annual Review of Genetics*, 23(1), pp.163–198. Available at: <http://dx.doi.org/10.1146/annurev.ge.23.120189.001115>.
- Gout, S., Tremblay, P.-L. & Huot, J., 2008. Selectins and selectin ligands in extravasation of cancer cells and organ selectivity of metastasis. *Clinical & Experimental Metastasis*, 25(4), pp.335–344. Available at: <http://dx.doi.org/10.1007/s10585-007-9096-4>.
- Grant, O.C. et al., 2014. Presentation, presentation, presentation! Molecular-level insight into linker effects on glycan array screening data. *Glycobiology*, 24 (1), pp.17–25. Available at: <http://glycob.oxfordjournals.org/content/24/1/17.abstract>.
- Grodberg, J. & Dunn, J.J., 1988. ompT encodes the Escherichia coli outer membrane protease that cleaves T7 RNA polymerase during purification. *Journal of Bacteriology*, 170 (3), pp.1245–1253. Available at: <http://jb.asm.org/content/170/3/1245.abstract>.
- Gudlaugsson, O. et al., 2003. Attributable mortality of nosocomial candidemia, revisited. *Clinical Infectious Diseases*, 37(9), pp.1172–1177. Available at: <http://www.ncbi.nlm.nih.gov/pubmed/14557960>.
- Gunnarsen, K.S. et al., 2010. Periplasmic expression of soluble single chain T cell receptors is rescued by the chaperone FkpA. *BMC Biotechnology*, 10, p.8. Available at: <http://www.pubmedcentral.nih.gov/articlerender.fcgi?artid=2834602&tool=pmc-entrez&rendertype=abstract>.
- Hagel, L. & Haneskog, L., 2010. Size-exclusion Chromatography. In *eLS*. John Wiley & Sons, Ltd. Available at: <http://dx.doi.org/10.1002/9780470015902.a0002676.pub2>.

- Han, Y. et al., 1997. Biochemical characterization of *Candida albicans* epitopes that can elicit protective and nonprotective antibodies. *Infection and Immunity*, 65(10), pp.4100–4107.
- Han, Y. & Cutler, J.E., 1995. Antibody response that protects against disseminated candidiasis. *Infection and Immunity*, 63(7), pp.2714–2719.
- Han, Y., Riesselman, M.H. & Cutler, J.E., 2000. Protection against Candidiasis by an Immunoglobulin G3 (IgG3) Monoclonal Antibody Specific for the Same Mannotriose as an IgM Protective Antibody T. R. Kozel, ed. *Infection and Immunity*, 68(3), pp.1649–1654. Available at: <http://www.pubmedcentral.nih.gov/articlerender.fcgi?artid=97325&tool=pmcentrez&rendertype=abstract>.
- Handbook, B.S.S., 2003. *version AA*, BR-1005-71, Biacore, Uppsala, Sweden.
- Hansson, G.C. & Zopf, D., 1985. Biosynthesis of the cancer-associated sialyl-Lea antigen. *Journal of Biological Chemistry*, 260 (16), pp.9388–9392. Available at: <http://www.jbc.org/content/260/16/9388.abstract>.
- Haselhorst, T., Weimar, T. & Peters, T., 2001. Molecular recognition of sialyl Lewis(x) and related saccharides by two lectins. *Journal of the American Chemical Society*, 123(43), pp.10705–10714. Available at: [http://www.ncbi.nlm.nih.gov/entrez/query.fcgi?cmd=Retrieve&db=PubMed&dopt=Citation&list\\_uids=11674003](http://www.ncbi.nlm.nih.gov/entrez/query.fcgi?cmd=Retrieve&db=PubMed&dopt=Citation&list_uids=11674003).
- Hazen, K.C. et al., 1991. Differential adherence of hydrophobic and hydrophilic *Candida albicans* yeast cells to mouse tissues. *Infection and Immunity*, 59(3), pp.907–912. Available at: <http://www.pubmedcentral.nih.gov/articlerender.fcgi?artid=258346&tool=pmcentrez&rendertype=abstract>.
- Henrissat, B., 1991. A classification of glycosyl hydrolases based on amino acid sequence similarities. *Biochemical Journal*, 280(Pt 2), pp.309–316. Available at: <http://www.pubmedcentral.nih.gov/articlerender.fcgi?artid=1130547&tool=pmcentrez&rendertype=abstract>.
- Henrissat, B. & Davies, G.J., 2000. Glycoside hydrolases and glycosyltransferases. Families, modules, and implications for genomics. *Plant physiology*, 124(4), pp.1515–1519. Available at: <http://europepmc.org/abstract/MED/11115868>.
- Herrmann, J.E., Hendry, R.M. & Collins, M.F., 1979. Factors involved in enzyme-linked immunoassay of viruses and evaluation of the method for identification of enteroviruses. *Journal of Clinical Microbiology*, 10 (2), pp.210–217. Available at: <http://jcm.asm.org/content/10/2/210.abstract>.
- Hobson, R.P. et al., 2004. Loss of cell wall mannosylphosphate in *Candida albicans* does not influence macrophage recognition. *The Journal of Biological*

- Chemistry*, 279(38), pp.39628–39635. Available at:  
<http://www.ncbi.nlm.nih.gov/pubmed/15271989>.
- Hochuli, E. et al., 1988. Genetic Approach to Facilitate Purification of Recombinant Proteins with a Novel Metal Chelate Adsorbent. *Nature Biotechnology*, 6(11), pp.1321–1325. Available at:  
<http://www.nature.com/nbt/journal/v6/n11/abs/nbt1188-1321.html>.
- Hochuli, E., Döbeli, H. & Schacher, A., 1987. New metal chelate adsorbent selective for proteins and peptides containing neighbouring histidine residues. *Journal Of Chromatography*, 411(0), pp.177–184. Available at:  
<http://linkinghub.elsevier.com/retrieve/pii/S0021967300939694>.
- Hoffmann, A. & Roeder, R.G., 1991. Purification of his-tagged proteins in non-denaturing conditions suggests a convenient method for protein interaction studies. *Nucleic acids research*, 19(22), pp.6337–6338. Available at:  
<http://europepmc.org/abstract/MED/1956801>.
- Holmes, E.H., Ostrander, G.K. & Hakomori, S., 1986. Biosynthesis of the sialyl-Lex determinant carried by type 2 chain glycosphingolipids (IV3NeuAcIII3FucnLc4, VI3NeuAcV3FucnLc6, and VI3NeuAcIII3V3Fuc2nLc6) in human lung carcinoma PC9 cells. *Journal of Biological Chemistry*, 261 (8), pp.3737–3743. Available at:  
<http://www.jbc.org/content/261/8/3737.abstract>.
- Hooper, L. V & Gordon, J.I., 2001. Glycans as legislators of host–microbial interactions: spanning the spectrum from symbiosis to pathogenicity. *Glycobiology*, 11 (2), p.1R–10R. Available at:  
<http://glycob.oxfordjournals.org/content/11/2/1R.abstract>.
- Husby, S. et al., 1985. Increased Non-Specific Binding of Heat-Treated Proteins to Plastic Surfaces Analyzed by ELISA and HPLC-Fractionation. *Journal of Immunoassay*, 6(1-2), pp.95–110. Available at:  
<http://www.tandfonline.com/doi/abs/10.1080/01971528508063023>.
- Huston, J.S. et al., 1988. Protein engineering of antibody binding sites: recovery of specific activity in an anti-digoxin single-chain Fv analogue produced in *Escherichia coli*. *Proceedings of the National Academy of Sciences*, 85 (16), pp.5879–5883. Available at: <http://www.pnas.org/content/85/16/5879.abstract>.
- Ilver, D. et al., 1998. Helicobacter pylori Adhesin Binding Fucosylated Histo-Blood Group Antigens Revealed by Retagging. *Science*, 279 (5349), pp.373–377. Available at: <http://www.sciencemag.org/content/279/5349/373.abstract>.
- Imber, M., Glasgow, L. & Pizzo, S., 1982. Purification of an almond emulsin fucosidase on Cibacron blue-sepharose and demonstration of its activity toward fucose-containing glycoproteins. *J. Biol. Chem.*, 257(14), pp.8205–8210. Available at: <http://www.jbc.org/cgi/content/long/257/14/8205> [Accessed November 23, 2012].

- Intasai, N. et al., 2009. Potent inhibition of OKT3-induced T cell proliferation and suppression of CD147 cell surface expression in HeLa cells by scFv-M6-1B9. *Immunobiology*, 214(6), pp.410–421. Available at: <http://www.sciencedirect.com/science/article/pii/S0171298508001599>.
- Jeong, K.J. & Lee, S.Y., 2002. Excretion of Human  $\beta$ -Endorphin into Culture Medium by Using Outer Membrane Protein F as a Fusion Partner in Recombinant *Escherichia coli*. *Applied and Environmental Microbiology*, 68 (10), pp.4979–4985. Available at: <http://aem.asm.org/content/68/10/4979.abstract>.
- Johnson, B.H. & Hecht, M.H., 1994. Recombinant proteins can be isolated from *E. coli* cells by repeated cycles of freezing and thawing. *Biotechnology Nature Publishing Company*, 12(13), pp.1357–1360. Available at: [http://www.ncbi.nlm.nih.gov/entrez/query.fcgi?db=pubmed&cmd=Retrieve&dopt=AbstractPlus&list\\_uids=7765566](http://www.ncbi.nlm.nih.gov/entrez/query.fcgi?db=pubmed&cmd=Retrieve&dopt=AbstractPlus&list_uids=7765566).
- Johnson, M.A. et al., 2012. Molecular recognition of *Candida albicans* (1 $\rightarrow$ 2)- $\beta$ -mannan oligosaccharides by a protective monoclonal antibody reveals the immunodominance of internal saccharide residues. *The Journal of Biological Chemistry*, pp.1–24. Available at: <http://www.ncbi.nlm.nih.gov/pubmed/22493450>.
- Johnson, S.W. & Alhadef, J.A., 1991. Mammalian alpha-L-fucosidases. *Comparative Biochemistry And Physiology B Comparative Biochemistry*, 99(3), pp.479–488.
- Johnsson, B., Löfås, S. & Lindquist, G., 1991. Immobilization of proteins to a carboxymethyl-dextran-modified gold surface for biospecific interaction analysis in surface plasmon resonance sensors. *Analytical Biochemistry*, 198(2), pp.268–277. Available at: <http://www.sciencedirect.com/science/article/pii/000326979190424R> [Accessed February 6, 2014].
- Kabat, E.A., 1966. The nature of an antigenic determinant. *The Journal of Immunology*, 97(1), pp.1–11.
- Kamena, F. et al., 2008. Synthetic GPI array to study antitoxic malaria response. *Nature chemical biology*, 4(4), pp.238–240.
- Kapust, R.B. & Waugh, D.S., 1999. *Escherichia coli* maltose-binding protein is uncommonly effective at promoting the solubility of polypeptides to which it is fused. *Protein Science*, 8(8), pp.1668–1674. Available at: <http://www.pubmedcentral.nih.gov/articlerender.fcgi?artid=2144417&tool=pmc&entrez&rendertype=abstract>.
- Karsunke, X.Z. et al., 2012. Development of single-chain variable fragment (scFv) antibodies against hapten benzo[a]pyrene: a binding study. *Analytical and Bioanalytical Chemistry*, 402(1), pp.499–507 LA – English. Available at: <http://dx.doi.org/10.1007/s00216-011-5389-1>.



- Katayama, T. et al., 2004. Molecular cloning and characterization of Bifidobacterium bifidum 1,2- $\alpha$ -L-fucosidase (AfcA), a novel inverting glycosidase (Glycoside hydrolase family 95). *Journal Of Bacteriology*, 186(15), pp.4885–4893.
- Kitagawa, H. & Paulson, J.C., 1993. Cloning and Expression of Human Gal $\beta$ 1,3(4)GlcNAc  $\alpha$ 2,3-Sialyltransferase. *Biochemical and Biophysical Research Communications*, 194(1), pp.375–382. Available at: <http://www.sciencedirect.com/science/article/pii/S0006291X83718309>.
- Knecht, S. et al., 2009. Oligohis-tags: mechanisms of binding to Ni<sup>2+</sup>-NTA surfaces. *Journal of Molecular Recognition*, 22(4), pp.270–279. Available at: <http://dx.doi.org/10.1002/jmr.941>.
- Kobata, A., 1982.  $\alpha$ -L-fucosidases from almond emulsin. In V. G. B. T.-M. in Enzymology, ed. *Complex Carbohydrates Part D*. Academic Press, pp. 625–631. Available at: <http://www.sciencedirect.com/science/article/pii/0076687982830619>.
- Kusters, J.G., van Vliet, A.H.M. & Kuipers, E.J., 2006. Pathogenesis of Helicobacter pylori Infection. *Clinical Microbiology Reviews* , 19 (3 ), pp.449–490. Available at: <http://cmr.asm.org/content/19/3/449.abstract>.
- Kyselova, Z. et al., 2008. Breast Cancer Diagnosis and Prognosis through Quantitative Measurements of Serum Glycan Profiles. *Clinical Chemistry* , 54 (7 ), pp.1166–1175. Available at: <http://www.clinchem.org/content/54/7/1166.abstract>.
- Lathe, G.H. & Ruthven, C.R., 1956. The separation of substances and estimation of their relative molecular sizes by the use of columns of starch in water. *Biochemical Journal*, 62(4), pp.665–674. Available at: <http://www.biochemj.org/bj/062/bj0620665.htm>.
- Lee, N., Francklyn, C. & Hamilton, E.P., 1987. Arabinose-induced binding of AraC protein to araI2 activates the araBAD operon promoter. *Proceedings of the National Academy of Sciences* , 84 (24 ), pp.8814–8818. Available at: <http://www.pnas.org/content/84/24/8814.abstract>.
- Lei, S.P. et al., 1987. Characterization of the Erwinia carotovora pelB gene and its product pectate lyase. *Journal of Bacteriology* , 169 (9 ), pp.4379–4383. Available at: <http://jb.asm.org/content/169/9/4379.abstract>.
- Leong, M.K. et al., 2007. Selection and characterization of lipase abzyme from phage displayed antibody libraries. *Biochemical and Biophysical Research Communications*, 361(3), pp.567–573. Available at: <http://www.sciencedirect.com/science/article/pii/S0006291X07014544>.
- Li, F. & Aitken, R., 2004. Cloning of porcine scFv antibodies by phage display and expression in Escherichia coli. *Veterinary Immunology and Immunopathology*,

- 97(1–2), pp.39–51. Available at:  
<http://www.sciencedirect.com/science/article/pii/S0165242703001879>.
- Li, Y. et al., 2002. Cloning and hemolysin-mediated secretory expression of a codon-optimized synthetic human interleukin-6 gene in *Escherichia coli*. *Protein Expression and Purification*, 25(3), pp.437–447. Available at:  
<http://www.sciencedirect.com/science/article/pii/S1046592802000281>  
 [Accessed February 18, 2014].
- Lichty, J.J. et al., 2005. Comparison of affinity tags for protein purification. *Protein expression and purification*, 41(1), pp.98–105. Available at:  
<http://www.sciencedirect.com/science/article/pii/S1046592805000276>  
 [Accessed January 22, 2014].
- Liedberg, B., Nylander, C. & Lundström, I., 1995. Biosensing with surface plasmon resonance — how it all started. *Biosensors and Bioelectronics*, 10(8), pp.i–ix. Available at:  
<http://www.sciencedirect.com/science/article/pii/0956566395969652> [Accessed February 11, 2014].
- Lim, K.-P., Li, H. & Nathan, S., 2004. Expression and purification of a recombinant scFv towards the exotoxin of the pathogen, *Burkholderia pseudomallei*. *Journal of microbiology Seoul Korea*, 42(2), pp.126–132. Available at:  
<http://www.ncbi.nlm.nih.gov/pubmed/15357306>.
- Listinsky, J.J., Siegal, G.P. & Listinsky, C.M., 2011. The emerging importance of  $\alpha$ -L-fucose in human breast cancer: a review. *American journal of translational research*, 3(4), pp.292–322. Available at:  
<http://www.pubmedcentral.nih.gov/articlerender.fcgi?artid=3158734&tool=pmc&rendertype=abstract>.
- Liu, Z.-X. et al., 2005. Identification of single-chain antibody fragments specific against SARS-associated coronavirus from phage-displayed antibody library. *Biochemical and Biophysical Research Communications*, 329(2), pp.437–444. Available at:  
<http://www.sciencedirect.com/science/article/pii/S0006291X05002263>.
- Madigan, M.T., 2005. Plasmids as Cloning Vectors. In *Brock Biology of Microorganisms*. SciELO Espana, pp. 256 – 289.
- Madigan, Michael T; Martinko, J.M., 2005. Essentials of Immunology. In *Brock Biology of Microorganisms*. SciELO Espana.
- Magnani, J.L., 2004. The discovery, biology, and drug development of sialyl Lea and sialyl Lex. *Archives of Biochemistry and Biophysics*, 426(2), pp.122–131. Available at: <http://www.ncbi.nlm.nih.gov/pubmed/15158662>.
- Makvandi-Nejad, S. et al., 2011. Selection and expression of recombinant single domain antibodies from a hyper-immunized library against the hapten

- azoxystrobin. *Journal of Immunological Methods*, 373(1–2), pp.8–18. Available at: <http://www.sciencedirect.com/science/article/pii/S0022175911001761>.
- Malik, P. et al., 1996. The  $\alpha(1,3)$ Fucosyltransferase Fuc-TVII Controls Leukocyte Trafficking through an Essential Role in L-, E-, and P-selectin Ligand Biosynthesis. *Cell*, 86(4), pp.643–653. Available at: <http://linkinghub.elsevier.com/retrieve/pii/S0092867400801373>.
- Malhotra, A., 2009. Tagging for Protein Expression. In R. R. B. and M. P. D. B. T.-M. in Enzymology, ed. *Guide to Protein Purification, 2nd Edition*. Academic Press, pp. 239–258. Available at: <http://www.sciencedirect.com/science/article/pii/S0076687909630160>.
- Manimala, J.C. et al., 2007. High-throughput carbohydrate microarray profiling of 27 antibodies demonstrates widespread specificity problems. *Glycobiology*, 17(8), p.17C–23C. Available at: <http://glycob.oxfordjournals.org/content/17/8/17C.abstract>.
- Mayer, M. & Buchner, J., 2004. Refolding of inclusion body proteins. *Methods in Molecular Medicine*, 94(3), pp.239–254. Available at: <http://www.ncbi.nlm.nih.gov/pubmed/14959834>.
- Maynard, J. & Georgiou, G., 2000. ANTIBODY ENGINEERING. *Annual Review of Biomedical Engineering*, 2(1), pp.339–376. Available at: <http://dx.doi.org/10.1146/annurev.bioeng.2.1.339>.
- Miano, M. et al., 2001. Four year follow-up of a case of fucosidosis treated with unrelated donor bone marrow transplantation. *Bone marrow transplantation*, 27(7), pp.747–751. Available at: <http://europepmc.org/abstract/MED/11360116>.
- Michalski, J.-C. & Klein, A., 1999. Glycoprotein lysosomal storage disorders:  $\alpha$ - and  $\beta$ -mannosidosis, fucosidosis and  $\alpha$ -N-acetylgalactosaminidase deficiency. *Biochimica et Biophysica Acta (BBA) - Molecular Basis of Disease*, 1455(2-3), pp.69–84. Available at: <http://www.sciencedirect.com/science/article/pii/S0925443999000770> [Accessed February 17, 2014].
- Mohanty, A.K. & Wiener, M.C., 2004. Membrane protein expression and production: effects of polyhistidine tag length and position. *Protein Expression and Purification*, 33(2), pp.311–325. Available at: <http://www.sciencedirect.com/science/article/pii/S1046592803003401>.
- Movva, N.R., Nakamura, K. & Inouye, M., 1980. Amino acid sequence of the signal peptide of ompA protein, a major outer membrane protein of Escherichia coli. *Journal of Biological Chemistry*, 255(1), pp.27–29. Available at: <http://www.jbc.org/content/255/1/27.abstract>.
- Müller, S. & Hanisch, F.-G., 2002. Recombinant MUC1 Probe Authentically Reflects Cell-specific O-Glycosylation Profiles of Endogenous Breast Cancer Mucin: HIGH DENSITY AND PREVALENT CORE 2-BASED

- GLYCOSYLATION . *Journal of Biological Chemistry* , 277 (29 ) , pp.26103–26112. Available at: <http://www.jbc.org/content/277/29/26103.abstract>.
- Nallamsetty, S. et al., 2005. Gateway vectors for the production of combinatorially-tagged His6-MBP fusion proteins in the cytoplasm and periplasm of *Escherichia coli*. *Protein Science*, 14(12), pp.2964–2971. Available at: <http://www.pubmedcentral.nih.gov/articlerender.fcgi?artid=2253240&tool=pmc-entrez&rendertype=abstract>.
- Narita, T. et al., 1993. Association of expression of blood group-related carbohydrate antigens with prognosis in breast cancer. *Cancer*, 71(10), pp.3044–3053. Available at: [http://dx.doi.org/10.1002/1097-0142\(19930515\)71:10<3044::AID-CNCR2820711026>3.0.CO](http://dx.doi.org/10.1002/1097-0142(19930515)71:10<3044::AID-CNCR2820711026>3.0.CO).
- Natsuka, S. et al., 1994. Molecular cloning of a cDNA encoding a novel human leukocyte alpha-1,3-fucosyltransferase capable of synthesizing the sialyl Lewis x determinant. *Journal of Biological Chemistry* , 269 (24 ) , pp.16789–16794. Available at: <http://www.jbc.org/content/269/24/16789.abstract>.
- Neufeld, E.F., 1991. Lysosomal storage diseases. *Annual review of biochemistry*, 60, pp.257–280. Available at: <http://europepmc.org/abstract/MED/1883197>.
- Nielsen, U.B. et al., 2006. A novel assay for monitoring internalization of nanocarrier coupled antibodies. *BMC Immunology*, 7, p.24. Available at: <http://www.pubmedcentral.nih.gov/articlerender.fcgi?artid=1633733&tool=pmc-entrez&rendertype=abstract>.
- Nitz, M. et al., 2002. The unique solution structure and immunochemistry of the *Candida albicans* beta -1,2-mannopyranan cell wall antigens. *The Journal of Biological Chemistry*, 277(5), pp.3440–3446. Available at: <http://www.ncbi.nlm.nih.gov/pubmed/11700318>.
- Occhiodoro, T. et al., 1992. Correction of alpha-L-fucosidase deficiency in fucosidosis fibroblasts by retroviral vector-mediated gene transfer. *Human gene therapy*, 3(4), pp.365–369. Available at: <http://europepmc.org/abstract/MED/1525209>.
- Okajima, T. et al., 1999. Molecular Cloning of a Novel  $\alpha$ 2,3-Sialyltransferase (ST3Gal VI) That Sialylates Type II Lactosamine Structures on Glycoproteins and Glycolipids. *Journal of Biological Chemistry* , 274 (17 ) , pp.11479–11486. Available at: <http://www.jbc.org/content/274/17/11479.abstract>.
- Palmer, I. & Wingfield, P.T., 2004. Preparation and extraction of insoluble (inclusion-body) proteins from *Escherichia coli*. *Current protocols in protein science editorial board John E Coligan et al*, Chapter 6, p.Unit 6.3. Available at: <http://www.ncbi.nlm.nih.gov/pubmed/18429271>.
- Le Pendu, J. et al., 2001. ABH and Lewis histo-blood group antigens in cancer. *APMIS*, 109(1), pp.9–26. Available at: <http://dx.doi.org/10.1111/j.1600-0463.2001.tb00011.x>.

- Pfaller, M.A. et al., 2001. International surveillance of bloodstream infections due to *Candida* species: frequency of occurrence and in vitro susceptibilities to fluconazole, ravuconazole, and voriconazole of isolates collected from 1997 through 1999 in the SENTRY antimicrobial surv. *Journal of Clinical Microbiology*, 39(9), pp.3254–3259. Available at: [http://www.ncbi.nlm.nih.gov/entrez/query.fcgi?cmd=Retrieve&db=PubMed&dopt=Citation&list\\_uids=11526159](http://www.ncbi.nlm.nih.gov/entrez/query.fcgi?cmd=Retrieve&db=PubMed&dopt=Citation&list_uids=11526159).
- Phillips, T.A., VanBogelen, R.A. & Neidhardt, F.C., 1984. Ion gene product of *Escherichia coli* is a heat-shock protein. *Journal of Bacteriology*, 159 (1), pp.283–287. Available at: <http://jb.asm.org/content/159/1/283.abstract>.
- Porath, J., 1960. Gel filtration of proteins, peptides and amino acids. *Biochimica et Biophysica Acta*, 39(2), pp.193–207. Available at: <http://www.sciencedirect.com/science/article/pii/0006300260901530>.
- Porath, J. et al., 1975. Metal chelate affinity chromatography, a new approach to protein fractionation. *Nature*, 258(5536), pp.598–599. Available at: <http://adsabs.harvard.edu/abs/1975Natur.258..598P>.
- Porath, J. & Flodin, P.R., 1959. Gel Filtration: A Method for Desalting and Group Separation. *Nature*, 183(4676), pp.1657–1659. Available at: <http://dx.doi.org/10.1038/1831657a0>.
- Prinz, W.A. et al., 1997. The Role of the Thioredoxin and Glutaredoxin Pathways in Reducing Protein Disulfide Bonds in the *Escherichia coli* Cytoplasm. *Journal of Biological Chemistry*, 272 (25), pp.15661–15667. Available at: <http://www.jbc.org/content/272/25/15661.abstract>.
- Pryor, K.D. & Leiting, B., 1997. High-Level Expression of Soluble Protein in *Escherichia coli* Using a His6-Tag and Maltose-Binding-Protein Double-Affinity Fusion System. *Protein Expression and Purification*, 10(3), pp.309–319. Available at: <http://www.sciencedirect.com/science/article/pii/S1046592897907592>.
- Pusztai, A. et al., 1988. Isolation of soybean trypsin inhibitors by affinity chromatography on anhydrotrypsin-Sepharose 4B. *Analytical Biochemistry*, 172(1), pp.108–112. Available at: <http://www.sciencedirect.com/science/article/pii/0003269788904186> [Accessed February 9, 2014].
- Qi, Y. et al., 2009. Selection of Anti-Sulfadimidine Specific ScFvs from a Hybridoma Cell by Eukaryotic Ribosome Display. *PLoS ONE*, 4(7), p.e6427. Available at: <http://dx.doi.org/10.1371/journal.pone.0006427>.
- Ravn, V. & Dabelsteen, E., 2000. Tissue distribution of histo-blood group antigens. *APMIS*, 108(1), pp.1–28. Available at: <http://dx.doi.org/10.1034/j.1600-0463.2000.d01-1.x>.

- Renkonen, J., Paavonen, T. & Renkonen, R., 1997. Endothelial and epithelial expression of sialyl Lewisx and sialyl Lewisia in lesions of breast carcinoma. *International Journal of Cancer*, 74(3), pp.296–300. Available at: [http://dx.doi.org/10.1002/\(SICI\)1097-0215\(19970620\)74:3<296::AID-IJC11>3.0.CO](http://dx.doi.org/10.1002/(SICI)1097-0215(19970620)74:3<296::AID-IJC11>3.0.CO).
- Rich, R.L. & Myszka, D.G., 2007. Higher-throughput, label-free, real-time molecular interaction analysis. *Analytical biochemistry*, 361(1), pp.1–6. Available at: <http://www.sciencedirect.com/science/article/pii/S0003269706008037> [Accessed February 4, 2014].
- Riggs, P., 2001. Expression and purification of maltose-binding protein fusions. *Current protocols in molecular biology edited by Frederick M Ausubel et al*, Chapter 16(1994), p.Unit16.6. Available at: <http://www.pubmedcentral.nih.gov/articlerender.fcgi?artid=2494979&tool=pmc-entrez&rendertype=abstract>.
- Riggs, P., 2000. Expression and purification of recombinant proteins by fusion to maltose-binding protein. *Molecular Biotechnology*, 15(1), pp.51–63. Available at: <http://dx.doi.org/10.1385/MB:15:1:51>.
- Rillahan, C.D. & Paulson, J.C., 2011. Glycan Microarrays for Decoding the Glycome. *Annual Review of Biochemistry*, 80(1), pp.797–823. Available at: <http://dx.doi.org/10.1146/annurev-biochem-061809-152236>.
- Rini, J.M., Esko, J.D. & Varki, A., 2009. Glycosyltransferases and Glycan-processing Enzymes. In A. Varki et al., eds. *Essentials of Glycobiology*. Cold Spring Harbor Laboratory Press, pp. 63 – 73.
- Routzahn, K. & Waugh, D., 2002. Differential effects of supplementary affinity tags on the solubility of MBP fusion proteins. *Journal of Structural and Functional Genomics*, 2(2), pp.83–92. Available at: <http://dx.doi.org/10.1023/A:1020424023207>.
- Sachdev, D. & Chirgwin, J.M., 1998a. Order of Fusions between Bacterial and Mammalian Proteins Can Determine Solubility in *Escherichia coli*. *Biochemical and Biophysical Research Communications*, 244(3), pp.933–937. Available at: <http://www.sciencedirect.com/science/article/pii/S0006291X98983656>.
- Sachdev, D. & Chirgwin, J.M., 1998b. Solubility of Proteins Isolated from Inclusion Bodies Is Enhanced by Fusion to Maltose-Binding Protein or Thioredoxin. *Protein Expression and Purification*, 12(1), pp.122–132. Available at: <http://www.sciencedirect.com/science/article/pii/S1046592897908263>.
- Sahdev, S., Khattar, S. & Saini, K., 2008. Production of active eukaryotic proteins through bacterial expression systems: a review of the existing biotechnology strategies. *Molecular and Cellular Biochemistry*, 307(1-2), pp.249–264. Available at: <http://dx.doi.org/10.1007/s11010-007-9603-6>.

- Sakurama, H. et al., 2012. Differences in the Substrate Specificities and Active-Site Structures of Two  $\alpha$ -L-Fucosidases (Glycoside Hydrolase Family 29) from *Bacteroides thetaiotaomicron*. *Bioscience, Biotechnology, and Biochemistry*, 76(5), pp.1022–1024.
- Saldova, R. et al., 2007. Ovarian cancer is associated with changes in glycosylation in both acute-phase proteins and IgG. *Glycobiology*, 17(12), pp.1344–1356. Available at: <http://www.ncbi.nlm.nih.gov/pubmed/17884841>.
- Salfeld, J.G., 2007. Isotype selection in antibody engineering. *Nature biotechnology*, 25(12), pp.1369–1372. Available at: <http://europepmc.org/abstract/MED/18066027>.
- Sano, M., Hayakawa, K. & Kato, I., 1992. Purification and characterization of alpha-L-fucosidase from *Streptomyces* species. *The Journal of biological chemistry*, 267(3), pp.1522–7. Available at: <http://www.ncbi.nlm.nih.gov/pubmed/1730698>.
- Sasaki, K. et al., 1994. Expression cloning of a novel alpha 1,3-fucosyltransferase that is involved in biosynthesis of the sialyl Lewis x carbohydrate determinants in leukocytes. *Journal of Biological Chemistry*, 269 (20 ), pp.14730–14737. Available at: <http://www.jbc.org/content/269/20/14730.abstract>.
- Scawen, M.D. & Hammond, P.M., 2000. Downstream processing: Protein extraction and purification. In J. M. Walker & R. Rapley, eds. *Molecular Biology and Biotechnology* (4). The Royal Society of Chemistry, pp. 461–496. Available at: <http://dx.doi.org/10.1039/9781847551498-00461>.
- Schroeder, H.W. & Cavacini, L., 2010. Structure and function of immunoglobulins. *The Journal of allergy and clinical immunology*, 125(2 Suppl 2), pp.S41–52. Available at: <http://www.sciencedirect.com/science/article/pii/S0091674909014651> [Accessed January 22, 2014].
- Schwarzer, D. et al., 2009. Proteolytic Release of the Intramolecular Chaperone Domain Confers Processivity to Endosialidase F. *Journal of Biological Chemistry*, 284 (14 ), pp.9465–9474. Available at: <http://www.jbc.org/content/284/14/9465.abstract>.
- Scudder, P. et al., 1990. The isolation by ligand affinity chromatography of a novel form of alpha-L-fucosidase from almond. *J. Biol. Chem.*, 265(27), pp.16472–16477. Available at: <http://www.jbc.org/cgi/content/long/265/27/16472> [Accessed November 24, 2012].
- Seddon, A.M., Curnow, P. & Booth, P.J., 2004. Membrane proteins, lipids and detergents: not just a soap opera. *Biochimica et biophysica acta*, 1666(1-2), pp.105–17. Available at: <http://www.sciencedirect.com/science/article/pii/S0005273604001610> [Accessed January 22, 2014].

- Sedov, S.A. et al., 2011. Lysis of *Escherichia coli* cells by lysozyme: discrimination between adsorption and enzyme action. *Colloids and surfaces. B, Biointerfaces*, 88(1), pp.131–3. Available at: <http://www.sciencedirect.com/science/article/pii/S0927776511003705> [Accessed February 12, 2014].
- Shaikh, F.A. et al., 2013. Identifying the Catalytic Acid/Base in GH29  $\alpha$ -L-Fucosidase Subfamilies. *Biochemistry*, 52(34), pp.5857–5864. Available at: <http://dx.doi.org/10.1021/bi400183q>.
- Sharon, N., 2008. Lectins: past, present and future. *Biochemical Society transactions*, 36(Pt 6), pp.1457–1460. Available at: <http://europepmc.org/abstract/MED/19021575>.
- Sharon, N. & Lis, H., 2004. History of lectins: from hemagglutinins to biological recognition molecules. *Glycobiology*, 14 (11), p.53R–62R. Available at: <http://glycob.oxfordjournals.org/content/14/11/53R.abstract>.
- Shirano, Y. & Shibata, D., 1990. Low temperature cultivation of *Escherichia coli* carrying a rice lipoxygenase L-2 cDNA produces a soluble and active enzyme at a high level. *FEBS Letters*, 271(1-2), pp.128–130. Available at: <http://www.sciencedirect.com/science/article/pii/001457939080388Y> [Accessed February 17, 2014].
- Sigal, G.B. et al., 1996. A Self-Assembled Monolayer for the Binding and Study of Histidine-Tagged Proteins by Surface Plasmon Resonance. *Analytical Chemistry*, 68(3), pp.490–497. Available at: <http://dx.doi.org/10.1021/ac9504023>.
- Smith, D.F., Song, X. & Cummings, R.D., 2010. Use of glycan microarrays to explore specificity of glycan-binding proteins. *Methods in enzymology*, 480, pp.417–44. Available at: <http://www.sciencedirect.com/science/article/pii/S0076687910800333> [Accessed January 27, 2014].
- Sørensen, H.P. & Mortensen, K.K., 2005. Soluble expression of recombinant proteins in the cytoplasm of *Escherichia coli*. *Microbial cell factories*, 4(1), p.1. Available at: <http://www.microbialcellfactories.com/content/4/1/1> [Accessed January 21, 2014].
- Stellwagen, E., 2009. Chapter 23 Gel Filtration. In R. R. B. and M. P. D. B. T.-M. in *Enzymology*, ed. *Guide to Protein Purification, 2nd Edition*. Academic Press, pp. 373–385. Available at: <http://www.sciencedirect.com/science/article/pii/S0076687909630238>.
- Studier, F.W., 2005. Protein production by auto-induction in high density shaking cultures. *Protein Expression and Purification*, 41(1), pp.207–234. Available at: <http://linkinghub.elsevier.com/retrieve/pii/S1046592805000264>.



- Sulzenbacher, G. et al., 2004. Crystal structure of *Thermotoga maritima* alpha-L-fucosidase. Insights into the catalytic mechanism and the molecular basis for fucosidosis. *The Journal of Biological Chemistry*, 279(13), pp.13119–13128.
- Tarling, C.A. et al., 2003. Identification of the catalytic nucleophile of the family 29 alpha-L-fucosidase from *Thermotoga maritima* through trapping of a covalent glycosyl-enzyme intermediate and mutagenesis. *The Journal of Biological Chemistry*, 278(48), pp.47394–47399. Available at: <http://www.jbc.org/cgi/content/abstract/278/48/47394>.
- Terpe, K.K., 2003. Overview of tag protein fusions: from molecular and biochemical fundamentals to commercial systems. *Applied Microbiology and Biotechnology*, 60(5), pp.523–533. Available at: <http://libgate.library.nuigalway.ie/login?url=http://search.proquest.com/docview/733005956?accountid=12899>.
- Todorovska, A. et al., 2001. Design and application of diabodies, triabodies and tetrabodies for cancer targeting. *Journal of Immunological Methods*, 248(1–2), pp.47–66. Available at: <http://www.sciencedirect.com/science/article/pii/S0022175900003422>.
- Tong, L. et al., 2000. Extracellular expression, purification, and characterization of a winter flounder antifreeze polypeptide from *Escherichia coli*. *Protein expression and purification*, 18(2), pp.175–81. Available at: <http://www.sciencedirect.com/science/article/pii/S1046592899911762> [Accessed February 17, 2014].
- Turner, P., Holst, O. & Karlsson, E.N., 2005. Optimized expression of soluble cyclomaltodextrinase of thermophilic origin in *Escherichia coli* by using a soluble fusion-tag and by tuning of inducer concentration. *Protein expression and purification*, 39(1), pp.54–60. Available at: <http://www.sciencedirect.com/science/article/pii/S1046592804003274> [Accessed February 17, 2014].
- Varki, A. et al., 2009. Discovery and classification of glycan-binding proteins. In A. Varki et al., eds. *Essentials of Glycobiology*. Cold Spring Harbor Laboratory Press, pp. 375 – 386.
- Varki, A., 1994. Review Selectin ligands. *Cancer*, 91(August), pp.7390–7397.
- Vasina, J.A. & Baneyx, F., 1997. Expression of aggregation-prone recombinant proteins at low temperatures: a comparative study of the *Escherichia coli* cspA and tac promoter systems. *Protein expression and purification*, 9(2), pp.211–8. Available at: <http://www.sciencedirect.com/science/article/pii/S1046592896906786> [Accessed February 17, 2014].
- Vasina, J.A. & Baneyx, F., 1996. Recombinant protein expression at low temperatures under the transcriptional control of the major *Escherichia coli* cold

- shock promoter *cspA*. *Applied and Environmental Microbiology*, 62 (4), pp.1444–1447. Available at: <http://aem.asm.org/content/62/4/1444.abstract>.
- Vogt Jr., R. V et al., 1987. Quantitative differences among various proteins as blocking agents for ELISA microtiter plates. *Journal of Immunological Methods*, 101(1), pp.43–50. Available at: <http://www.sciencedirect.com/science/article/pii/0022175987902146>.
- De Vries, T., Knegt, R.M.A., et al., 2001. Fucosyltransferases: structure/function studies. *Glycobiology*, 11 (10), p.119R–128R. Available at: <http://glycob.oxfordjournals.org/content/11/10/119R.abstract>.
- De Vries, T., Storm, J., et al., 2001. Production of soluble human  $\alpha$ 3-fucosyltransferase (FucT VII) by membrane targeting and in vivo proteolysis. *Glycobiology*, 11 (9), pp.711–717. Available at: <http://glycob.oxfordjournals.org/content/11/9/711.abstract>.
- Wang, C.-C. et al., 2009. Glycans on influenza hemagglutinin affect receptor binding and immune response. *Proceedings of the National Academy of Sciences*, 106 (43), pp.18137–18142. Available at: <http://www.pnas.org/content/106/43/18137.abstract>.
- Wang, D. et al., 2007. Photogenerated glycan arrays identify immunogenic sugar moieties of *Bacillus anthracis* exosporium. *PROTEOMICS*, 7(2), pp.180–184. Available at: <http://dx.doi.org/10.1002/pmic.200600478>.
- Wang, J.-W., Asnani, A. & Auzanneau, F.-I., 2010. Synthesis of a BSA-Lex glycoconjugate and recognition of Lex analogues by the anti-Lex monoclonal antibody SH1: The identification of a non-cross reactive analogue. *Bioorganic & Medicinal Chemistry*, 18(20), pp.7174–7185. Available at: <http://www.sciencedirect.com/science/article/pii/S0968089610007856>.
- Weis, W.I. & Drickamer, K., 1996. Structural Basis of Lectin-Carbohydrate Recognition. *Annual Review of Biochemistry*, 65(1), pp.441–473. Available at: <http://dx.doi.org/10.1146/annurev.bi.65.070196.002301>.
- Weisser, N.E. & Hall, J.C., 2009. Applications of single-chain variable fragment antibodies in therapeutics and diagnostics. *Biotechnology Advances*, 27(4), pp.502–520. Available at: <http://www.sciencedirect.com/science/article/pii/S0734975009000548>.
- Wenzel, R.P., 1995. *Nosocomial candidemia: risk factors and attributable mortality.*, Oxford University Press. Available at: <http://cid.oxfordjournals.org/content/20/6/1531.short>.
- Werner, M.H. et al., 1994. Refolding proteins by gel filtration chromatography. *FEBS Letters*, 345(2–3), pp.125–130. Available at: <http://www.sciencedirect.com/science/article/pii/0014579394004013>.

- Willems, P.J. et al., 1999. Spectrum of mutations in fucosidosis. *European Journal of Human Genetics*, 7(1), p.60. Available at: <http://search.ebscohost.com/login.aspx?direct=true&db=a9h&AN=8854537&site=ehost-live>.
- William Studier, F. et al., 1990. *Gene Expression Technology*, Elsevier. Available at: <http://www.sciencedirect.com/science/article/pii/007668799085008C> [Accessed January 22, 2014].
- Wilson, I.A. & Stanfield, R.L., 1994. Antibody-antigen interactions: new structures and new conformational changes. *Current Opinion in Structural Biology*, 4(6), pp.857–867. Available at: <http://www.sciencedirect.com/science/article/pii/0959440X94902674> [Accessed February 5, 2014].
- Yang, Q. et al., 2003. High-level expression of a soluble snake venom enzyme, glosedobin, in *E. coli* in the presence of metal ions. *Biotechnology Letters*, 25(8), pp.607–610. Available at: <http://dx.doi.org/10.1023/A:1023067626846>.
- Yin, J. et al., 2007. Select what you need: a comparative evaluation of the advantages and limitations of frequently used expression systems for foreign genes. *Journal of biotechnology*, 127(3), pp.335–47. Available at: <http://www.sciencedirect.com/science/article/pii/S0168165606006237> [Accessed January 22, 2014].
- Yuan, Q. et al., 1997. Molecular cloning, expression, and characterization of a functional single-chain Fv antibody to the mycotoxin zearalenone. *Applied and Environmental Microbiology*, 63(1), pp.263–269. Available at: <http://aem.asm.org/content/63/1/263.abstract>.
- Yuan, Q. et al., 2009. Screening of high-affinity scFvs from a ribosome displayed library using BIAcore biosensor. *Applied Biochemistry And Biotechnology*, 152(2), pp.224–234. Available at: <http://www.ncbi.nlm.nih.gov/pubmed/18574567>.
- Zale, S.E. & Klibanov, A.M., 1986. Why does ribonuclease irreversibly inactivate at high temperatures? *Biochemistry*, 25(19), pp.5432–5444. Available at: <http://dx.doi.org/10.1021/bi00367a014>.
- Zhu, J., 2012. Mammalian cell protein expression for biopharmaceutical production. *Biotechnology advances*, 30(5), pp.1158–70. Available at: <http://www.sciencedirect.com/science/article/pii/S0734975011001674> [Accessed January 22, 2014].

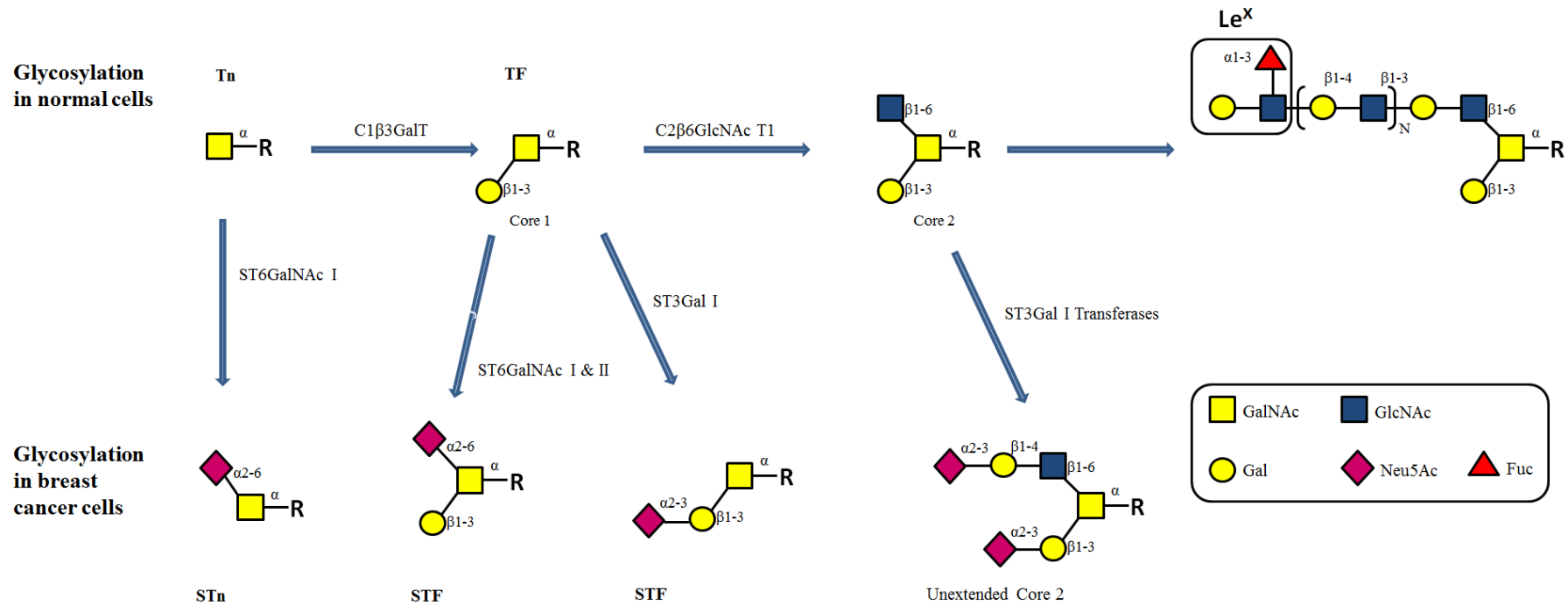
## Chapter 4: Development of Fucosidase as a specific binding protein for fucose

### 4.1 Introduction

#### 4.1.1 Glycosylation

Glycosylation is a type of post-translational modification that involves the addition of glycans onto proteins to form glycoproteins. The glycans can be either O-linked via a Ser or Thr residue or N-linked via an Asn residue. On cell surfaces glycans play different functions, such as facilitating cell-cell interactions, as well as acting as ligands for viral entry and infection, and cell-microbe interactions. Glycans function also depends on the nature of the glycoconjugate and the cell on which they are present (A. Varki; J.B. Lowe 2009). For instance, it has been shown that in cancerous cells a change in the glycosylation results in shorter polylactosamine chains (Müller & Hanisch 2002) and in more sialylated (Cazet et al. 2010) and fucosylated (Listinsky et al. 2011) glycan structures, such as the ones shown in Figure 4.1. Indeed, the proliferation of glycans such as Lewis X ( $Le^x$ ) sialyl Lewis x ( $sLe^x$ ), sialyl Lewis a ( $sLe^a$ ) or Thomsen-Friedenreich antigen (TF antigen) on the cell surfaces has been implicated in different carcinomas (Narita et al. 1993; Cazet et al. 2010; Abd Hamid et al. 2008; Renkonen et al. 1997; Saldova et al. 2007; Arnold et al. 2011).

The overexpression of Lewis antigens;  $Le^a$ ,  $Le^b$ ,  $Le^x$  and  $Le^y$  has been detected in cancerous cells as reviewed by Le Pendu *et al.* in a number of different cancers including lung, thyroid, bladder and ovarian (Le Pendu et al. 2001). Normal breast tissue expresses  $Le^x$  while  $sLe^x$  is usually only present at low intensity (Croce et al. 2007), however, in breast cancer cells there is an overexpression of  $sLe^x$  (Cazet et al. 2010; Abd Hamid et al. 2008). Increased type II carbohydrates and a reduction in type I carbohydrates has been reported in the cancerous portion of breast lesions (Narita et al. 1993). This increase in type II antigens was also linked to a poorer prognosis for patients (Narita et al. 1993) and high levels of  $sLe^x$  expression have been linked to cancer progression (Kyselova et al. 2008). Cancerous cells circulating in blood with  $sLe^x$  present on their surface can bind to the selectins (Renkonen et al. 1997), and along with secondary adhesion mechanisms (Gout et al. 2008) can lead to extravasation into another organ.



**Figure 4.1:** Biosynthesis of glycans in normal and breast cancer cells. The biosynthesis of an O-glycan with terminal Lewis x saccharide in normal glycosylation and the truncated or sialylated tumour associated carbohydrate antigens sialyl-Thomsen-nouvelle (sTn), sialyl Thomsen-Friedenreich (sialyl-TF) and sialylated core 2 glycans. The enzymes involved in the biosynthesis were: Galactosyltransferase – C1β3GalT, N-acetylglucosaminyltransferase - C2β6GlcNAcT1, and sialyltransferases – ST6GalNAc I and ST6GalNAc II.

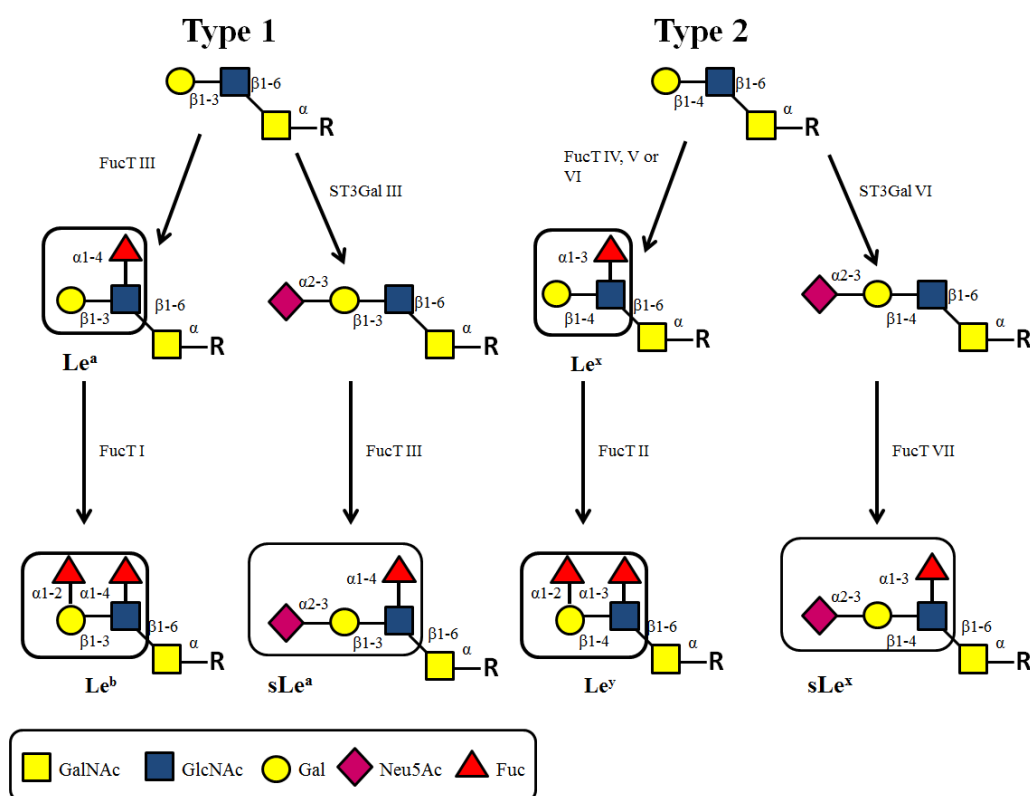
Bacteria and viruses can adhere to specific glycans on human host tissue through pathogen-surface proteins, such as the adhesins or hemagglutinins. For example, the bacterium *Helicobacter pylori* uses the adhesin BabA to adhere to human gastric epithelial cells via Le<sup>b</sup> (Ilver et al. 1998; Boren et al. 1993). Gastric colonisation by *H. pylori* can lead to gastritis, ulcers and even gastric cancer (Kusters et al. 2006).

Normal cell function also exploits protein adhesion to cell-surface glycans. The sLe<sup>x</sup> epitopes are recognised by the carbohydrate-binding proteins E-, P-, and L-selectins which are expressed on endothelial cells, leukocytes and platelets (Cummings & McEver 2009). Selectins are responsible for the normal trafficking of lymphocytes during an inflammation response (Magnani 2004) and also facilitate leukocyte adhesion and rolling on the endothelium (Gout et al. 2008).

#### 4.1.2 Lewis antigen biosynthesis

Most human epithelial tissues express the histo-blood group antigens; Le<sup>a</sup>, Le<sup>b</sup>, sLe<sup>a</sup>, Le<sup>x</sup>, Le<sup>y</sup>, and sLe<sup>x</sup>, which are derived by substitution of type I (Gal $\beta$ 1-3GlcNAc) or type II (Gal $\beta$ 1-4GlcNAc) disaccharides with fucose and sialic acid residues (Ravn & Dabelsteen 2000). The antigens Le<sup>a</sup>, Le<sup>b</sup>, and sLe<sup>a</sup> are derived from type I sequences while Le<sup>x</sup>, Le<sup>y</sup>, and sLe<sup>x</sup> are derived from type II antigens. Le<sup>a</sup> and Le<sup>x</sup> are generated by the addition of a  $\alpha$ 1-4 linked and of a  $\alpha$ 1-3 linked fucose, respectively, to the GlcNAc. Furthermore the addition of a  $\alpha$ 1-2 linked fucose to the Gal of Le<sup>a</sup> and of Le<sup>x</sup> generates Le<sup>b</sup> and Le<sup>y</sup>, respectively (Figure 4.2). During the biosynthesis of sLe<sup>a</sup> and sLe<sup>x</sup>,  $\alpha$ 2-3 linked sialylation of the Gal residue occurs before fucosylation (Hansson & Zopf 1985; Holmes et al. 1986). After this step, the GlcNAc may be fucosylated with either a  $\alpha$ 1-4 linked fucose to give sLe<sup>a</sup>, or a  $\alpha$ 1-3 linked fucose to form sLe<sup>x</sup>. Sialyltransferase ST3Gal III mainly acts on type I rather than type II disaccharides, and is involved in the synthesis of sLe<sup>a</sup> (Kitagawa & Paulson 1993), while ST3Gal VI has a preference for type II disaccharides, and forms the precursor for sLe<sup>x</sup> (Okajima et al. 1999). Fucosyltransferase FucT III is predominantly involved in the addition of  $\alpha$ 1-4 fucose as found in Le<sup>a</sup> and sLe<sup>a</sup> (de Vries, Knegt, et al. 2001; Brazil et al. 2013). FucT IV, FucT V or FucT VI can add  $\alpha$ 1-3 linked fucose to type II disaccharides to form Le<sup>x</sup> or sLe<sup>x</sup> (de Vries, Knegt, et al. 2001),

whereas fucosyltransferase FucT VII is specific for the synthesis of sLe<sup>x</sup>; it only fucosylates the sialylated type II precursor (Sasaki et al. 1994; Natsuka et al. 1994; Malý et al. 1996; de Vries, Storm, et al. 2001). The addition of  $\alpha$ 1-2 linked fucose to Gal to form the Le<sup>b</sup> or Le<sup>y</sup> antigens is carried out by FucT I and FucT II respectively, with FucT I having a preference for type I carbohydrates and FucT II for type II carbohydrates (Cazet et al. 2010).



**Figure 4.2:** Biosynthesis of Lewis antigens: Le<sup>a</sup>, Le<sup>b</sup>, sLe<sup>a</sup>, Le<sup>x</sup>, Le<sup>y</sup> and sLe<sup>x</sup>. The enzymes involved in the synthesis were:  $\alpha$ 1-3/4 fucosyltransferases (FucT) – FucT I, FucT II, FucT III, FucT IV, FucT V, FucT VI or FucT VII and  $\alpha$ 2-3 sialyltransferases – ST3Gal III, ST3Gal IV or ST3Gal VII.

### 4.1.3 Inactive Enzymes as Substrate-Affinity Reagents

Overexpression of Lewis antigens on the surface of cells makes them an interesting target for the development of diagnostic reagents. One approach to developing such reagents involves the conversion of carbohydrate processing enzymes into inactive highly-specific carbohydrate binding proteins. For example, an inactive endo-sialidase can function as a lectin specific for poly 2-8 sialic acid (Schwarzer et al. 2009). A similar concept has also been employed to generate an affinity reagent from inactive trypsin that can be employed for the isolation of trypsin inhibitors (Pusztai et al. 1988). Because these engineered carbohydrate binding proteins are derived directly from enzymes, and display lectin like properties, we named them Lectenz. Enzymes are usually highly selective for the substrates they catalyse. This makes them a more interesting target for development into a reagent with high affinity and specificity. Antibodies are used for detection of glycans but there has been cases of cross reactivity (Manimala et al. 2007) which can be undesirable. Lectins generally have weak affinities (Weis & Drickamer 1996) but due to multivalent interactions can result in increased avidity (Varki et al. 2009; Ghazarian et al. 2011; Dam et al. 2005). Here the enzyme chosen as a potential candidate for conversion to a Lectenz was  $\alpha$ -L-Fucosidase from *Thermotoga maritima* (Sulzenbacher et al. 2004; Tarling et al. 2003), which is the closest bacterial relative to mammalian fucosidase. This enzyme was also chosen as its 3D structure has been reported (Sulzenbacher et al. 2004).

### 4.1.4 $\alpha$ -L-Fucosidase

$\alpha$ -L-Fucosidases (EC 3.2.1.51) are exoglycosidases that are members of the glycoside hydrolase family 29 (GH29) (Henrissat 1991). All known  $\alpha$ -L-Fucosidases are retaining enzymes, and are able to cleave one or more of the following fucose linkages:  $\alpha$ 1-2,  $\alpha$ 1-3,  $\alpha$ 1-4 or  $\alpha$ 1-6. Earlier studies have shown that mammalian  $\alpha$ -L-fucosidases are more active against fucose linked  $\alpha$ 1-2 to Gal, relative to fucose linked  $\alpha$ 1-3,  $\alpha$ 1-4 or  $\alpha$ 1-6 to GlcNAc (Johnson & Alhadeff 1991). The two almond-emulsion fucosidases have different specificities;  $\alpha$ -L-fucosidase I cleaves fucose linked  $\alpha$ 1-3 or  $\alpha$ 1-4, while II cleaves  $\alpha$ 1-2 or  $\alpha$ 1-6 linked fucose



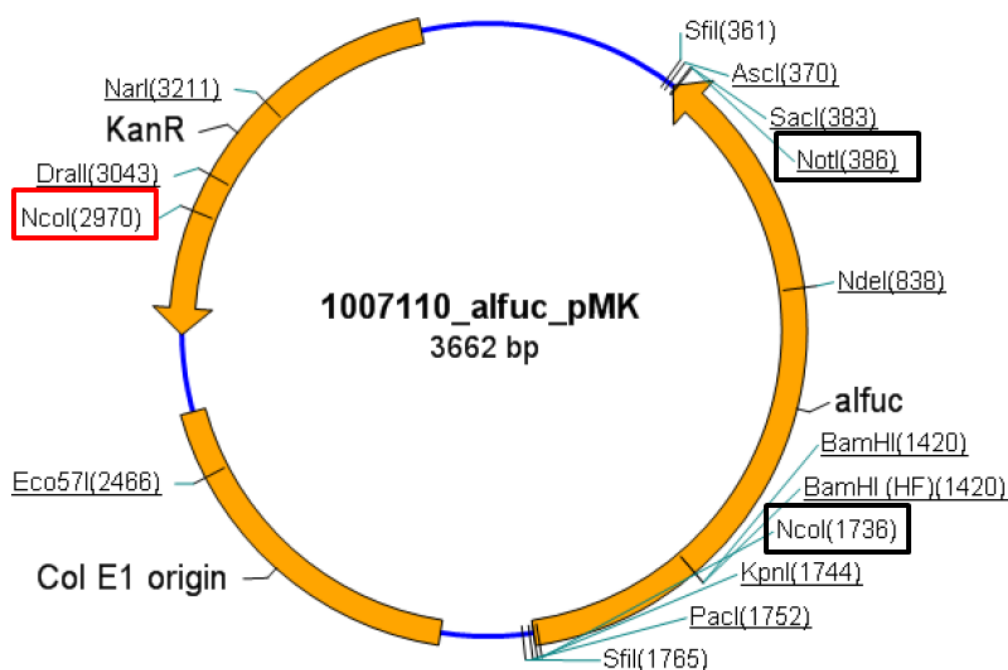
(Scudder et al. 1990; Imber et al. 1982; Kobata 1982). Two  $\alpha$ -L-fucosidases from *Bifidobacterium bifidum* (AfcA and AfcB) have been identified, which are essential for the defucosylation of milk oligosaccharides. AfcA cleaves  $\alpha$ 1-2 linked fucose (Katayama et al. 2004) while AfcB is specific for  $\alpha$ 1-3 and  $\alpha$ 1-4 linkages (Ashida et al. 2009). As in the cases of  $\alpha$ -L-fucosidase I from almond emulsion and AfcB, the fucosidase from *Streptomyces* species 142 only hydrolyses  $\alpha$ 1-3 or  $\alpha$ 1-4 linked fucose, but showed no activity against sLe<sup>a</sup> (Sano et al. 1992).

The  $\alpha$ -L-fucosidase from *Thermotoga maritima* is the closest bacterial relative to mammalian  $\alpha$ -L-fucosidases having 38% identity with human fucosidase (Sulzenbacher et al. 2004). Its crystal structure was determined and it was found that the *T. maritima* is a two-domain protein. The N-terminal has a  $(\beta/\alpha)_8$ -barrel-like fold, with eight parallel  $\beta$ -strands packed around a central axis and surrounded by six  $\alpha$ -helices. The active site is situated in a depression at the C-terminal ends of the  $\beta$ -strands. The C-terminal domain is composed of eight anti-parallel  $\beta$ -strands packed into two  $\beta$ -sheets of five and three, forming a two-layer  $\beta$ -sandwich containing a Greek key motif and small  $\alpha$ -helix (Sulzenbacher et al. 2004). In the crystal structure the  $\alpha$ -L-fucosidase was found to in hexameric arrangement, with two trimers stacked on top of each other. Free cysteine residues were not located close enough to for disulfide bonds. This hexameric state was also observed by size exclusion chromatography suggesting that the hexamer state also prevails in solution. The catalytic nucleophile was identified as the aspartic acid residue 224 (Tarling et al. 2003) and the acid/base catalyst as glutamic acid 266 (Sulzenbacher et al. 2004). It was found that a D224A mutant had a  $10^4$ -fold decrease in activity in comparison to the wild type enzyme. The specificity of this fucosidase for different fucose linkages is not known, which motivated us to study its interaction with glycans containing fucose in a variety of linkages, including the Lewis antigens.

## 4.2 Results & Discussion

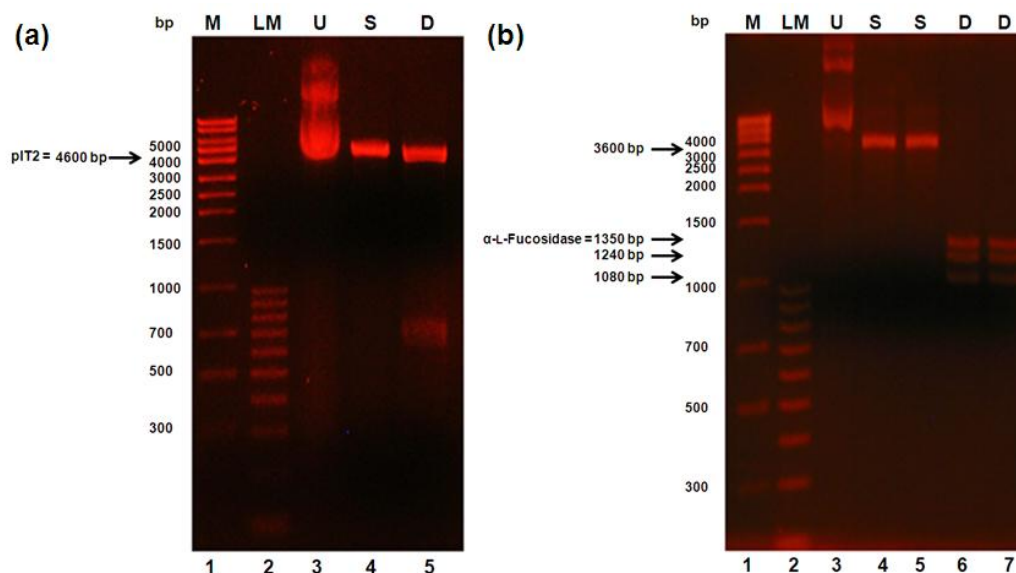
### 4.2.1 Cloning into the pIT2 plasmid vector

The  $\alpha$ -L-fucosidase based on  $\alpha$ -L-fucosidase from *Thermotoga maritima* (Sulzenbacher et al. 2004) was engineered by GeneArt<sup>®</sup> and contained 5' *NcoI* and 3' *NotI* restriction sites. The  $\alpha$ -L-Fucosidase DNA sequence showing the 5' *NcoI* and 3' *NotI* restriction sites and also the protein translation sequence are in Appendix II. It had been cloned into the pMK vector and contained kanamycin resistance. To clone the  $\alpha$ -L-Fucosidase into the pIT2 phagemid vector (Figure 3.5), both the pIT2 vector and pMK were digested with *NcoI* and *NotI* restriction enzymes. For the pMK this should have resulted in two fragments, the plasmid backbone and the  $\alpha$ -L-fucosidase. However, the presence of an unexpected *NcoI* restriction site in the plasmid backbone resulted in three fragments of approximately 1080, 1240 and 1350 base pairs respectively (Figure 4.3) instead of the anticipated two fragments of approximately 1350 and 2320 base pairs.



**Figure 4.3:**  $\alpha$ -L-Fucosidase cloned into the pMK vector from GeneArt<sup>®</sup> containing kanamycin resistance. The requested restriction sites of *NcoI* at the 5' and *NotI* at the 3' ends are highlighted in black. The additional *NcoI* restriction site is highlighted in red.

A 2% agarose gel was used to excise the  $\alpha$ -L-Fucosidase (1350 bp) from the other digested plasmid fragments and to separate the three fragments sufficiently. The pIT2 was separated using a 1% agarose gel as shown in Figure 4.4.



**Figure 4.4:** DNA electrophoresis of (a) a 1% agarose gel showing undigested, linearized and double digested C3.1 pIT2 vector (4.6 kb), and (b) a 2% agarose gel showing undigested, linearized with *NotI* and double digested  $\alpha$ -L-Fucosidase (3.6 kb). Lanes in panel (a): (1) M = molecular weight ladder (300 bp – 10000 bp), (2) LM = low molecular weight ladder (100 bp – 1000 bp), (3) U = undigested plasmid, (4) S = single digested plasmid, and (5) D = double digested plasmid. Lanes in panel (b): (1) M = molecular weight ladder (300 bp – 10000 bp), (2) LM = low molecular weight ladder (100 bp – 1000 bp), (3) U = undigested plasmid, (4 - 5) S = single digested plasmid, and (6 - 7) D = double digested plasmid.

The  $\alpha$ -L-Fucosidase was cloned into the pIT2 vector, using T4 DNA ligase. The ligated products were transformed into non-suppressor *E. coli* HB2151 cells. Ampicillin resistance was used as a selection marker, and colonies were then cultured in LB media. Plasmids were prepared and sequenced with the LMB3 and pHEN sequencing primers (sequences shown in materials) to confirm the  $\alpha$ -L-Fucosidase sequence (Figure 4.5).

```

WT_ALF      MISMKPRYKPDWESLREHTVPKWFDKAKFGIFIHWGIYSVPGWA
ALF         MASMKPRYKPDWESLREHTVPKWFDKAKFGIFIHWGIYSVPGWA
*          *

WT_ALF      TPTGELGKVPMDAWFFQNPYAEWYENSLRIKESPTWEYHVKTYG
ALF         TPTGELGKVPMDAWFFQNPYAEWYENSLRIKESPTWEYHVKTYG
*          *

WT_ALF      ENFEYEKPADLFTAEEKWDPQEWADLFKKAGAKYVIPTTKHHDGF
ALF         ENFEYEKPADLFTAEEKWDPQEWADLFKKAGAKYVIPTTKHHDGF
*          *

WT_ALF      CLWGTKYTDFN SVKRGPKRDLVGD LAKAVREAGLRFVYYSGGL
ALF         CLWGTKYTDFN SVKRGPKRDLVGD LAKAVREAGLRFVYYSGGL
*          *

WT_ALF      DWRFTTEPIRYPEDLSYIRPNTY EYADYAYKQVMELVDLYLPDV
ALF         DWRFTTEPIRYPEDLSYIRPNTY EYADYAYKQVMELVDLYLPDV
*          *

WT_ALF      LWNDMGWPEK GKEDLKYLFAYYYNKHPEGSVNDRWGVPHWDFKT
ALF         LWNDMGWPEK GKEDLKYLFAYYYNKHPEGSVNDRWGVPHWDFKT
*          *

WT_ALF      AEYHVNYPGDLPGYKWEFTRGIGLSFGYNRNEGPEHMLSVEQLV
ALF         AEYHVNYPGDLPGYKWEFTRGIGLSFGYNRNEGPEHMLSVEQLV
*          *

WT_ALF      YTLVDVVSKGGNLLLNVGPKGDGTIPDLQKERLLGLGEWLRKYG
ALF         YTLVDVVSKGGNLLLNVGPKGDGTIPDLQKERLLGLGEWLRKYG
*          *

WT_ALF      DAIYGTSVWERCCA KTEDGTEIRFTRKCNRI FVIFLGIP TGEKI
ALF         DAIYGTSVWERCCA KTEDGTEIRFTRKCNRI FVIFLGIP TGEKI
*          *

WT_ALF      VIEDLNL SAGTVRHF LTGERLSFKNVGKNLEITVPK LLETDSI
ALF         VIEDLNL SAGTVRHF LTGERLSFKNVGKNLEITVPK LLETDSI
*          *

WT_ALF      TLVLEAVEE-----
ALF         TLVLEAVEEAAAHHHHHH
*          *

```

**Figure 4.5:** Sequence alignment of *Thermotoga maritima*  $\alpha$ -L-Fucosidase (WT\_ALF) with the synthesized  $\alpha$ -L-Fucosidase (ALF) in the pIT2 vector

#### 4.2.2 Generation of the D224A and D224N mutants

The catalytic nucleophile of the *Thermotoga maritima*  $\alpha$ -L-Fucosidase was identified as the aspartic acid residue 224 (D224) by Tarling *et al.* (Tarling *et al.* 2003), and it was found that mutation of this residue to an alanine, resulted in a  $10^4$ -fold lower activity in comparison to the wild type enzyme. Based on this identification of the catalytic nucleophile, we aimed to generate two inactive mutants of the wild type  $\alpha$ -L-Fucosidase by replacing the catalytic nucleophile residue Asp 224, with an alanine (D224A) as a comparison to the mutant generated by (Tarling *et al.* 2003) and an asparagine (D224N) which would have a similar structural configuration to the original aspartic acid residue. The generation of these mutants was carried out via site-directed mutagenesis, using the Invitrogen Platinum<sup>®</sup> Pfx DNA polymerase. While a 3-step cycling protocol was successful to generate the D224N mutant, it was found that a 2-step cycling protocol with a final concentration of 2X PCR<sub>x</sub> Enhancer Solution was the optimal condition to generate the D224A mutant. The products of the site-directed mutagenesis reactions were transformed into *E. coli* HB2151 cells. Ampicillin resistance was used as a selection marker, and colonies were then cultured in LB media. Plasmids were prepared and sequenced with the LMB3 and pHEN sequencing primers (sequences shown in materials) and the D224A and D224N sequences confirmed (Figure 4.6).

```

WT_ALF      NTY EYADYAYKQVMELVDLYLPDVLWN DMGWPERGKEDLKYLFA
D224A      NTY EYADYAYKQVMELVDLYLPDVLWN AMGWPERGKEDLKYLFA
D224N      NTY EYADYAYKQVMELVDLYLPDVLWN NMGWPERGKEDLKYLFA
*****

```

**Figure 4.6:** Partial sequence alignment, of *Thermotoga maritima*  $\alpha$ -L-Fucosidase (WT\_ALF) with the D224A and D224N mutants

### 4.2.3 Expression of the D224A/D224N mutants

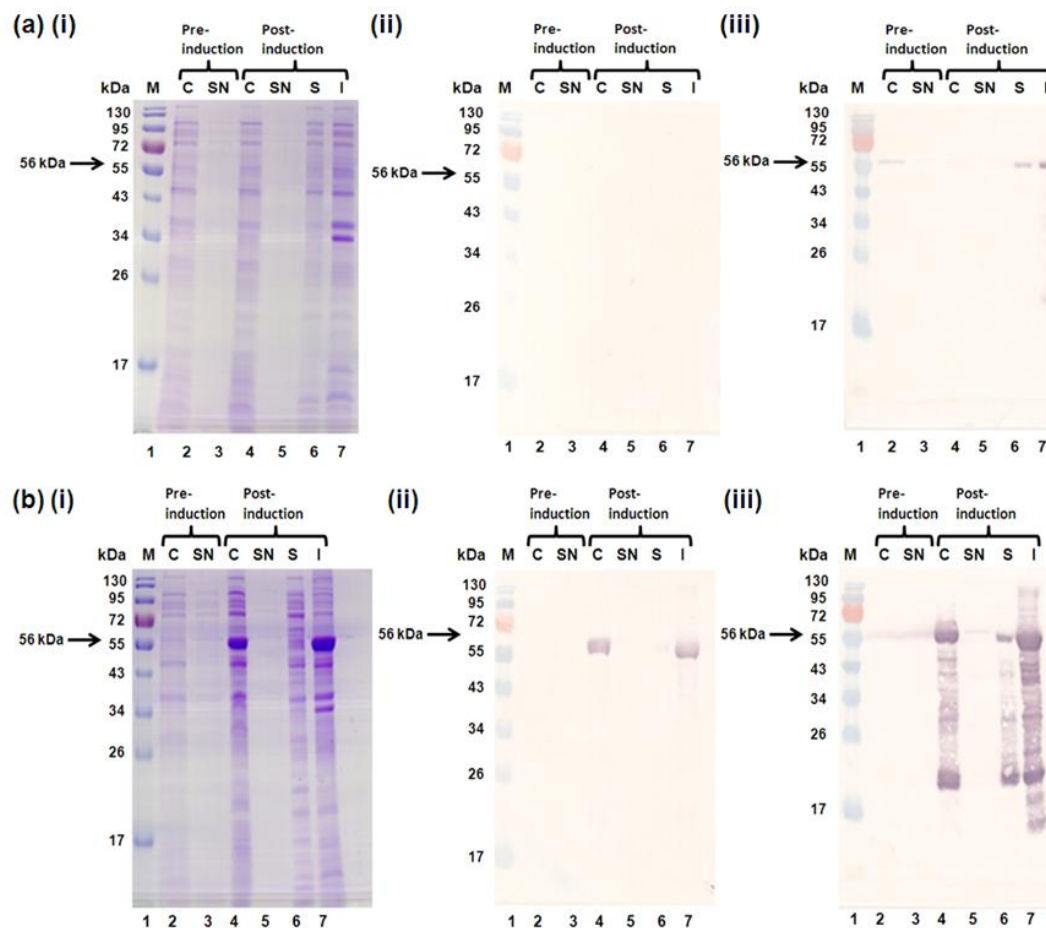
Test expressions of both the D224A and D224N mutants were carried out at 18 °C and 37 °C. After reaching the required OD, the cells were induced with 1 mM IPTG and expression was continued overnight at 18 °C or for 4 hours at 37 °C. Aliquots of the crude culture and culture supernatant, pre- and post-induction, and the soluble and insoluble fractions were analysed by SDS-PAGE and western blot. Samples were boiled in reducing sample buffer and electrophoresed on 12% SDS-PAGE gels. The approximate molecular weight of the D224A and D224N mutants as detected by SDS-PAGE was 55 kDa. Theoretical molecular weights were calculated using the ExPASy ProtParam tool (Artimo et al. 2012) and results are shown in Table 4.1.

**Table 4.1:** Theoretical molecular weights of D224A and D224N  $\alpha$ -L-Fucosidase mutants

Mutant	Theoretical Molecular Weight
D224A	54853 Da
D224N	54896 Da

There was no visible band present in analysis by SDS-PAGE at 55 kDa for the D224A mutant when expressed at 18 °C as shown in lanes 4 – 7, panel (a)(i) in Figure 4.7. To detect if there was any of the D224A protein present, western blot analysis was carried out using both an anti-penta His antibody and an anti myc-tag antibody. This resulted in no detection of protein expression at 18 °C using the penta-His antibody, as shown in panel (a)(ii) in Figure 4.7, although the anti myc-tag antibody detected some protein in both the soluble and insoluble fractions in lane 6 & 7, in panel (a)(iii) of Figure 4.7. Although there was detection of protein in panel (a)(iii), due to the corresponding band on the SDS-PAGE (panel (a)(i), Figure 4.7) being faint, it would suggest that there was very little expression of the mutant at this temperature, which would be difficult to purify in sufficient yield for further analysis. In comparison to expression at 18 °C, there was visible overexpression of the D224A mutant when expressed at 37 °C as shown in lane 4, panel (b)(i), Figure 4.7. However the majority of the protein expressed was present in insoluble protein in the form of inclusion bodies as shown in lane 7, panel (b)(i) in Figure 4.7. The expression of the D224A mutant in inclusion bodies was confirmed by western blot

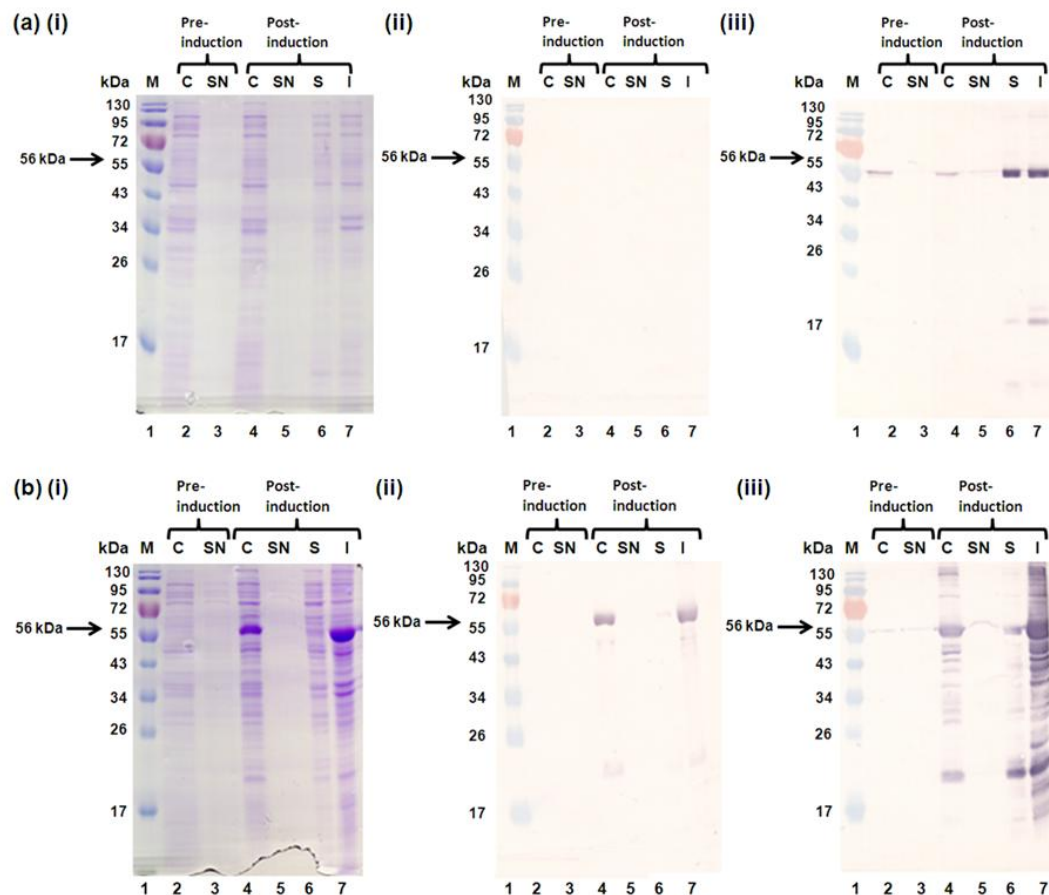
analysis as shown in lane 7 in panel (b)(ii) in Figure 4.7, using the anti-penta His antibody and in lane 7 in panel (b)(iii) in Figure 4.7 using the anti-myc tag antibody.



**Figure 4.7:** SDS-PAGE and western blot analysis of the D224A mutant expressed at 18 °C and 37 °C. (a)(i) SDS-PAGE of D224A expression at 18 °C, (a)(ii) western blot of D224A expression at 18 °C, with detection using an anti-penta His antibody, (a)(iii) western blot of D224A expression at 18 °C, with detection using an anti myc-tag antibody, (b)(i) SDS-PAGE of D224A expression at 37 °C, (b)(ii) western blot of D224A expression at 37 °C, with detection using an anti-penta His antibody, and (b)(iii) western blot of D224A expression at 37 °C, with detection using an anti myc-tag antibody. Lanes (1) molecular weight ladder, (2) crude culture pre-induction with IPTG, (3) culture supernatant pre-induction with IPTG, (4) crude culture post-induction, (5) culture supernatant post-induction, (6) soluble fraction, (7) insoluble fraction.

The D224N mutant behaved in a similar way to the D224A mutant when expression was carried out at 18 °C and 37 °C. There was no visible overexpression of the D224N mutant at 18 °C when analysed by SDS-PAGE as shown in lanes 4 – 7, panel (a)(i) in Figure 4.8. Western blot analysis was used to detect if there was any D224N present using both an anti-penta His antibody and an anti myc-tag antibody. There was no detection of protein expression at 18 °C using the penta-His antibody, as shown in panel (a)(ii) in Figure 4.8, although the anti myc-tag antibody detected some protein in both the soluble and insoluble fractions in lane 6 & 7, in panel (a)(iii) of Figure 4.8. Although there was detection of protein in panel (a)(iii), due to the faint corresponding band on the SDS-PAGE (panel (a)(i), Figure 4.7), it would suggest that there was very little expression of the mutant at this temperature, which would be difficult to purify in sufficient yield for further analysis. In comparison to expression at 18 °C, there was visible overexpression of the D224N mutant when expressed at 37 °C as shown in lane 4, panel (b)(i), Figure 4.8. Unfortunately, the majority of the protein expressed was present in insoluble protein in the form of inclusion bodies as shown in lane 7, panel (b)(i) in Figure 4.8. Analysis by western blot was carried out using both the anti-penta His antibody and also the anti myc-tag antibody to confirm the protein present was the D224N mutant. The D224N present in inclusion bodies can be seen in lane 7 in panel (b)(ii) in Figure 4.8, using the anti-penta His antibody and in lane 7 in panel (b)(iii) in Figure 4.8 using the anti-myc tag antibody. Both mutants expressed in very low yields when expressed at 18 °C, and due to this would not be a suitable method of expression. Also when expressed at 37 °C both mutants were present as insoluble protein in inclusion bodies. Although proteins have been successfully refolded and purified from inclusion bodies (Mayer & Buchner 2004), this method was not chosen for the purification of the D224A and D224N mutants, as the binding specificity of the  $\alpha$ -L-Fucosidase is not known, and the purification of the mutants from soluble protein would be preferred.





**Figure 4.8:** SDS-PAGE and western blot analysis of the D224N mutant expressed at 18 °C and 37 °C. (a)(i) SDS-PAGE of D224N expression at 18 °C, (a)(ii) western blot of D224N expression at 18 °C, with detection using an anti-penta His antibody, (a)(iii) western blot of D224N expression at 18 °C, with detection using an anti myc-tag antibody, (b)(i) SDS-PAGE of D224N expression at 37 °C, (b)(ii) western blot of D224N expression at 37 °C, with detection using an anti-penta His antibody, and (b)(iii) western blot of D224N expression at 37 °C, with detection using an anti myc-tag antibody. Lanes (1) molecular weight ladder, (2) crude culture pre-induction with IPTG, (3) culture supernatant pre-induction with IPTG, (4) crude culture post-induction, (5) culture supernatant post-induction, (6) soluble fraction, (7) insoluble fraction.

#### 4.2.4 Cloning into the *pMAL-c5x* expression vector

Overexpression of recombinant proteins in *E.coli* can lead to the formation of insoluble protein aggregates called inclusion bodies. This was observed for both of the  $\alpha$ -L-Fucosidase mutants. One method to overcome protein aggregation is by solubilisation of the inclusion bodies with denaturing agents, followed by refolding the protein to its native state. Within this approach, the initial step is to isolate the inclusion bodies from other cell components by centrifugation (Mayer & Buchner 2004). Cells can be disrupted in a French press, or by sonication, or by treatment with lysozyme, or DNase I (Mayer & Buchner 2004; De Bernardez Clark 1998). The inclusion bodies are then washed with buffers containing EDTA, chaotropic agents or detergents to help remove contaminants. For the solubilisation of inclusion bodies, there are several different methods that can be used, including treatment at low or high pH, addition of organic solvents, or detergents, or increased temperature. Some proteins in the presence of low or high pH retain less of their structure, while in organic solvents proteins are partially unfolded. The use of high temperatures for unfolding proteins may lead to irreversible denaturation (Zale & Klibanov 1986). The use of denaturing agents such as 6 M guanidine hydrochloride or 8 M urea are the most common (Palmer & Wingfield 2004). Denaturation of the proteins is also usually carried out in the presence of a reducing agent, such as  $\beta$ -mercaptoethanol or dithiothritol to reduce any cysteines (Palmer & Wingfield 2004; De Bernardez Clark 1998; Mayer & Buchner 2004).

To refold the solubilised protein, the concentration of denaturing agent needs to be reduced, for example, by dilution, dialysis or gel filtration (Palmer & Wingfield 2004; De Bernardez Clark 1998). Dilution involves a large ratio of renaturation buffer usually 10 – 100 fold. The denatured protein can also be refolded by dialysis against renaturation buffer. This is a slower process and may also be a cause of some aggregation if the protein is exposed to intermediate concentrations of denaturing buffer for an extended time. Another method described by Werner et al (Werner et al. 1994), consists of refolding via gel filtration, also known as “on-column refolding”. The protein in denaturing buffer is added to a column, and the refolding buffer is used as the mobile phase. Transport of the protein through the column

facilitates in refolding the protein and also in separating the correctly folded protein from any remaining protein aggregates.

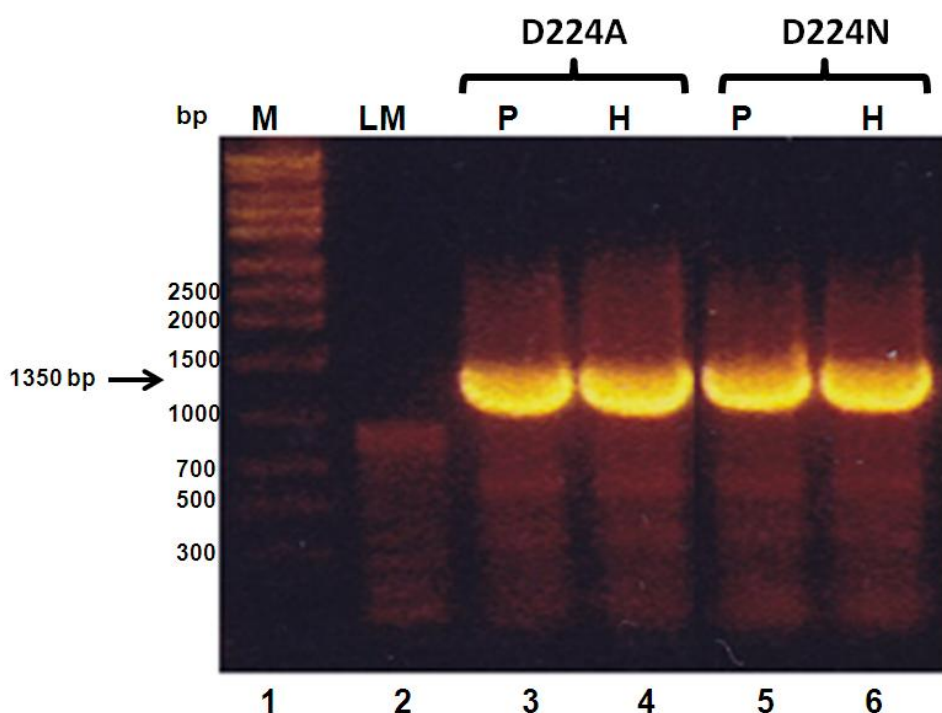
Glynou et al. reported a one-step purification and refolding of His-tagged apoaequorin (Glynou et al. 2003). The solubilised lysate was incubated with Ni-NTA agarose slurry, after which the urea was removed with a linear gradient of 6 M – 0 M urea. To remove any non-specific proteins, the column was washed with 20 mM imidazole, followed by elution with 200 mM imidazole.

It is assumed that protein from inclusion bodies when solubilised and refolded will be in its native state. This requires secondary confirmation, such as by a functional binding or enzyme activity assay. However, as the specificity of the  $\alpha$ -L-Fucosidase is not known, confirming binding of the inactive mutants was not a practical option. Instead, it was decided that an alternative method than isolations from inclusion bodies followed by refolding, should be used. In fact, we chose to improve the  $\alpha$ -L-Fucosidase mutants' solubility by expressing them as fusion proteins.

There are a number of different proteins that can be used to enhance the solubility of their fusion partner. Some of these include thioredoxin, glutathione S-transferase and maltose binding protein (MBP) (Esposito & Chatterjee 2006). As reported by Kapust and Waugh (Kapust & Waugh 1999), MBP was a more effective solubilising agent when tested with six different proteins that form inclusion bodies. The position of the MBP on either the N- or C-terminus has been shown to have an effect on the solubility of the fusion protein. For example, when the MBP was present at the N-terminus of the fusion with pepsinogen or procathepsin D, there was soluble expression (Sachdev & Chirgwin 1998a), whereas when fused to the C-terminal of pepsinogen or procathepsin D the fusion would result in inclusion body formation (Sachdev & Chirgwin 1998b).

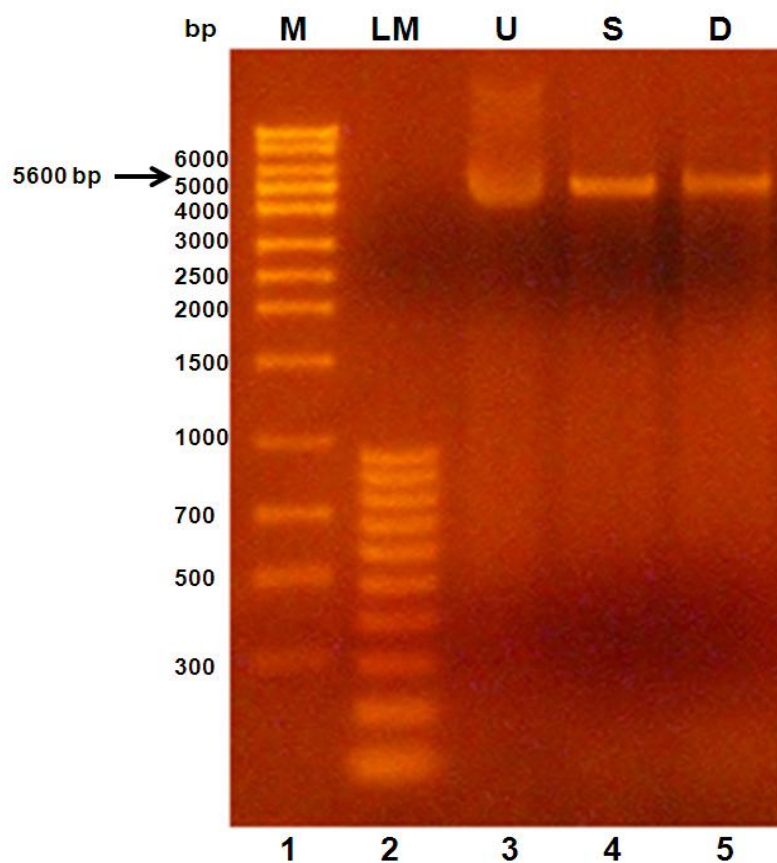
The commercially available pMAL vectors from New England Biolabs, are maltose binding protein vectors that can be used for the expression of fusion proteins containing a N-terminal maltose binding protein. There are vectors available that either directs expression to the cytoplasm (pMAL-c vectors) or the periplasm (pMAL-p). A number of different options for cleavage sites in the pMAL vectors are available, these include: factor Xa, enterokinase, and genease I (Riggs 2000; Fox &

Waugh 2003; Riggs 2001). We decided to clone the mutants into the pMAL-c5x vector. This would introduce the MBP to the N-terminus of the mutants with a factor Xa cleavage site. The MBP acts both, as a solubility enhancer, and as an affinity tag. Indeed MBP has a strong affinity for amylose, so this could potentially be utilized as a method for purification, as well as for detection by western blot when probed with anti-MBP antibodies. We wanted to introduce a His-tag at the C-terminal of the mutants to be used during purification as well as for detection of the  $\alpha$ -L-Fucosidase mutants following cleavage from the maltose binding protein. To clone in the mutants into the pMAL-c5X, both the D224A and D224N mutants were amplified with the introduction of a penta- or hex-His tag and an *EcoRI* restriction site at the C-terminal as shown in Figure 4.9.



**Figure 4.9:** Amplification of the D224A/D224N mutants with a penta- His tag and *EcoRI* restriction site or a hexa-His tag and *EcoRI* restriction sites. Lanes: (1) M = molecular weight ladder (300 – 10000 bp), (2) LM = low molecular weight ladder (100 – 1000 bp), (3) P = penta-His tag and *EcoRI* restriction site, (4) H = hexa-His tag and *EcoRI* restriction site, (5) P = penta-His tag and *EcoRI* restriction site and (6) H = hexa-His tag and *EcoRI* restriction site.

After purification, the amplified D224A/D224N mutant products (data not shown) were digested with the *NcoI* and *EcoRI* restriction enzymes along with the pMAL-c5X plasmid (Figure 4.10). The ligation reactions were transformed into BL21 *E. coli* cells, and plated on LB agar plates supplemented with carbenicillin. Colonies were picked and cultured, and successful ligation reactions were confirmed by sequencing of the plasmid DNA. The D224N  $\alpha$ -L-Fucosidase mutant was successfully cloned into the pMAL-c5x vector with a pentahistidine tag, as confirmed by sequencing, and this clone was used for all subsequent work.



**Figure 4.10:** DNA electrophoresis of a 1% agarose gel showing undigested linearized and double digested pMAL-c5x vector (5.6kb). Lanes: (1) M = molecular weight ladder (300 bp – 10000 bp), (2) LM = low molecular weight ladder (100 bp – 1000 bp), (3) U = undigested pMAL-c5x vector, (4) S = single digested pMAL-c5X and (5) D = double digested pMAL-c5x vector.

#### 4.2.5 Expression of the D224N-MBP fusion protein

The D224N-5His-MBP fusion protein was expressed in *E. coli* BL21 cells at 37 °C for 4 hours after induction with 1 mM IPTG. The BL21 cells were re-suspended in lysis buffer and were treated with lysozyme, DNase I and PMSF. After disruption of the cells by sonication, the cell lysate was centrifuged to separate the soluble fraction from the insoluble fraction. The lysate was sterile filtered before purification. There was both soluble and insoluble expression of the D224N-5His-MBP fusion protein which was present at 95 kDa on a 12% reducing SDS-PAGE gel as shown in lane 4 and 5 respectively in Figure 4.11. Theoretical molecular weight of the D224N-5His-MBP fusion protein was calculated using the ExPASy ProtParam tool (Artimo et al. 2012) and results are shown in Table 4.3.

**Table 4.2:** Theoretical molecular weights of D224N-5His-MBP fusion and the D224N-5His after cleavage from MBP

<b>Protein</b>	<b>Theoretical Molecular Weight</b>
D224N-5His-MBP	95340 Da
D224N-5His	52847 Da

Initially the D224N-5His-MBP was purified using amylose resin (Riggs 2001). The lysate was added to amylose resin and eluted with 10 mM maltose. For the D224N-5His-MBP fusion protein, this purification method gave a low yield with the majority of the protein found in the flow through and wash steps (data not shown). Binding of maltose binding proteins to amylose resin is not always sufficient and can result in low yield or purity (Routzahn & Waugh 2002; Pryor & Leiting 1997; Nallamsetty et al. 2005).

As an alternative, purification of the D224N-5His-MBP fusion protein was carried out by IMAC. The sterile filtered cell lysate was diluted with binding buffer (IMAC A buffer, containing 10 mM imidazole) and loaded onto a nickel charged 5 ml HisTrap column. The column was washed with elution buffer (IMAC B containing 500 mM imidazole) to remove some of the contaminating proteins and equilibrate

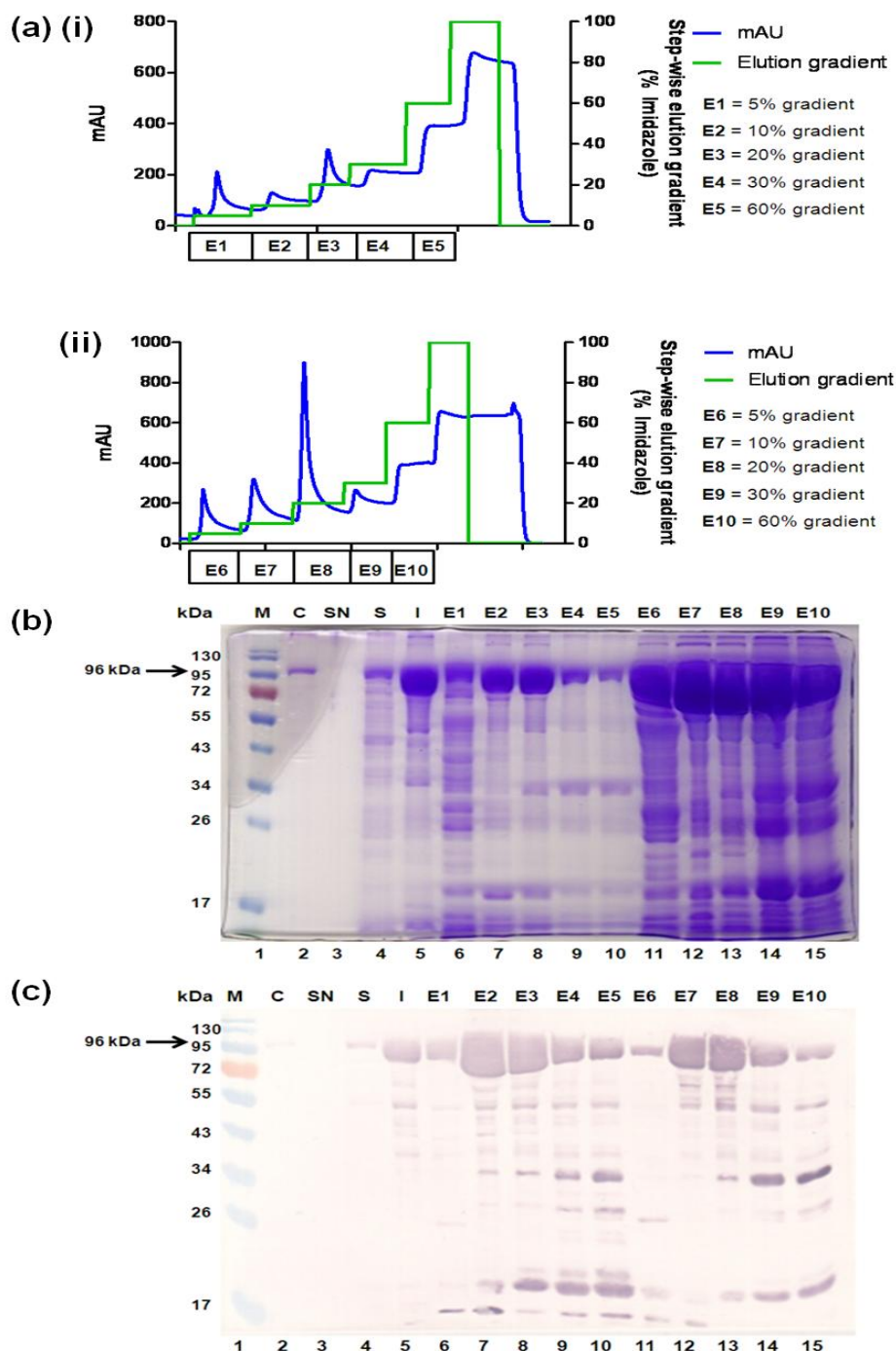
the baseline. Elution of the protein was done using a stepwise gradient and IMAC B, containing 500 mM imidazole. A typical chromatograph for the initial round of purification is shown in panel (a)(ii) in Figure 4.11 and the SDS-PAGE analysis of the eluted fractions is shown in lanes 11 – 15, in Figure 4.11. This showed the presence of a lot of contaminating proteins which may have been due to the presence of native *E. coli* proteins that have high affinities for divalent ions such as nickel (Bolanos-Garcia & Davies 2006). When analysed on a reducing 12 % SDS-PAGE gel, it was found that some of the D224N-5His-MBP protein was present in the flow-through from the initial purification (data not shown). This flow-through was then re-loaded onto the HisTrap column for further purification by IMAC as described previously. A typical chromatograph for the second round of purification is shown in panel (a)(i) in Figure 4.11 and the SDS-PAGE analysis of the eluted fractions is shown in lanes 6 – 10, in Figure 4.11. After the initial two round of IMAC, all the eluted fractions were pooled together and purified again by IMAC but using a 1 ml HisTrap column. The third round of IMAC improved the purity of the D224N-5His-MBP, but there were still some contaminating bands that needed to be removed before cleavage of the maltose binding protein from the D224N  $\alpha$ -L-fucosidase. A typical chromatograph for the third round of purification is shown in panel (a) in Figure 4.121 and the SDS-PAGE analysis of the eluted fractions is shown in lanes 2 – 6, in panel (b) in Figure 4.12.

Western blot analysis of all eluted fractions from the first rounds of IMAC were carried out and the blots were probed with either an anti-penta His or anti-MBP antibody. The anti-His mAb detected the presence of the D224N-5His-MBP at 97 kDa as shown in panel (c) in Figure 4.11 and in panel (c) in Figure 4.12. The anti-MBP Ab also detected the D224N-5His-MBP (data not shown) but it was also cross-reactive and detected a number of other proteins. This was seen more when the blocking reagent for the western blot was either bovine serum albumin or skim milk powder. It was found that 1% fish gelatin in PBS was a more effective blocking reagent. For all further western blot analysis, anti-His tag mAb was chosen to probe the blots, with fish gelatin used as a blocking reagent.

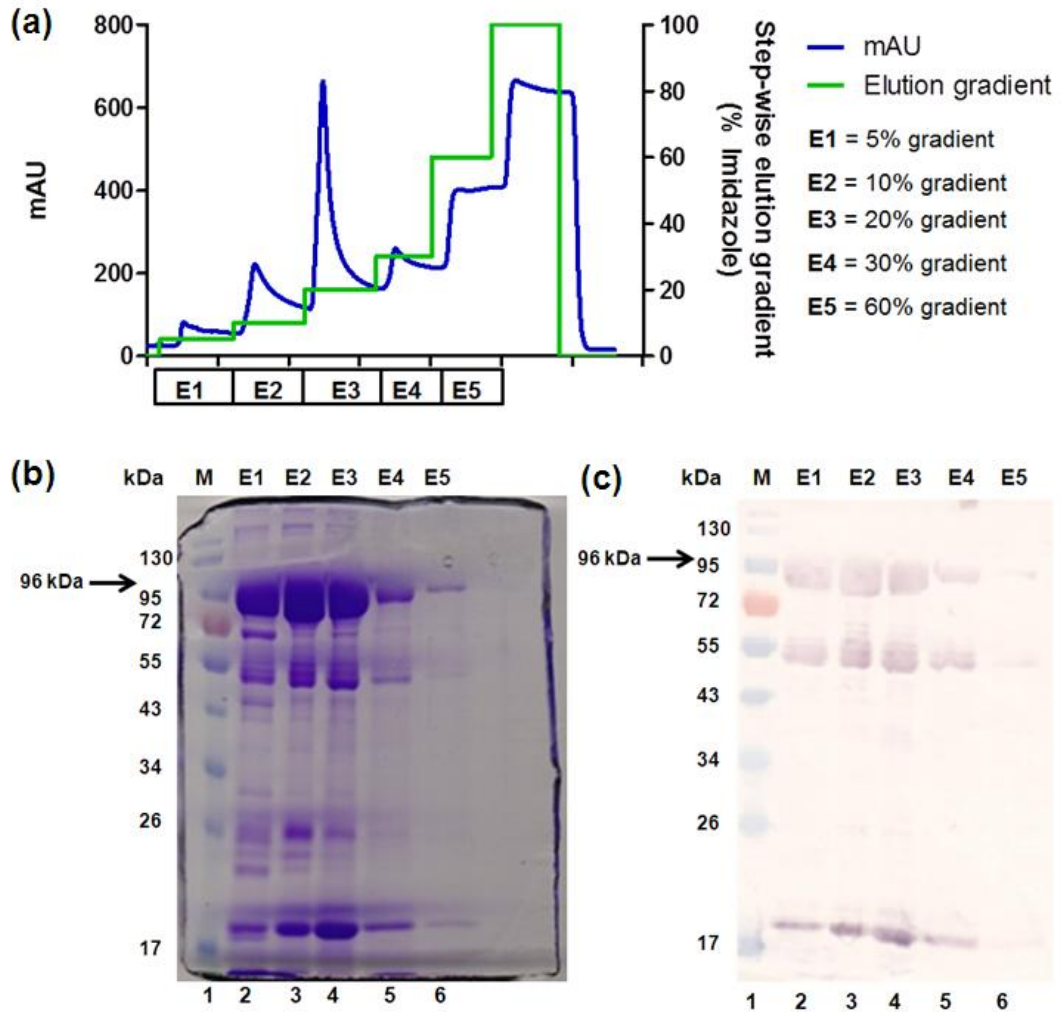
As a final polishing step, the D224N-5His-MBP was purified using SEC. The pooled IMAC purified protein was concentrated to approximately 500  $\mu$ l and loaded onto a

Superdex™ 75 10/300 GL column. As the protein was transported through the column, the D224N-5His-MBP was found to elute at approximately 8.5 ml after injection. A typical chromatograph for the SEC of D224N-5His-MBP is shown in panel (a) in Figure 4.13. Aliquots from the eluted fractions were analysed on 12% reducing SDS-PAGE gels as shown in lanes 2 – 15 in panel (b) in Figure 4.13.

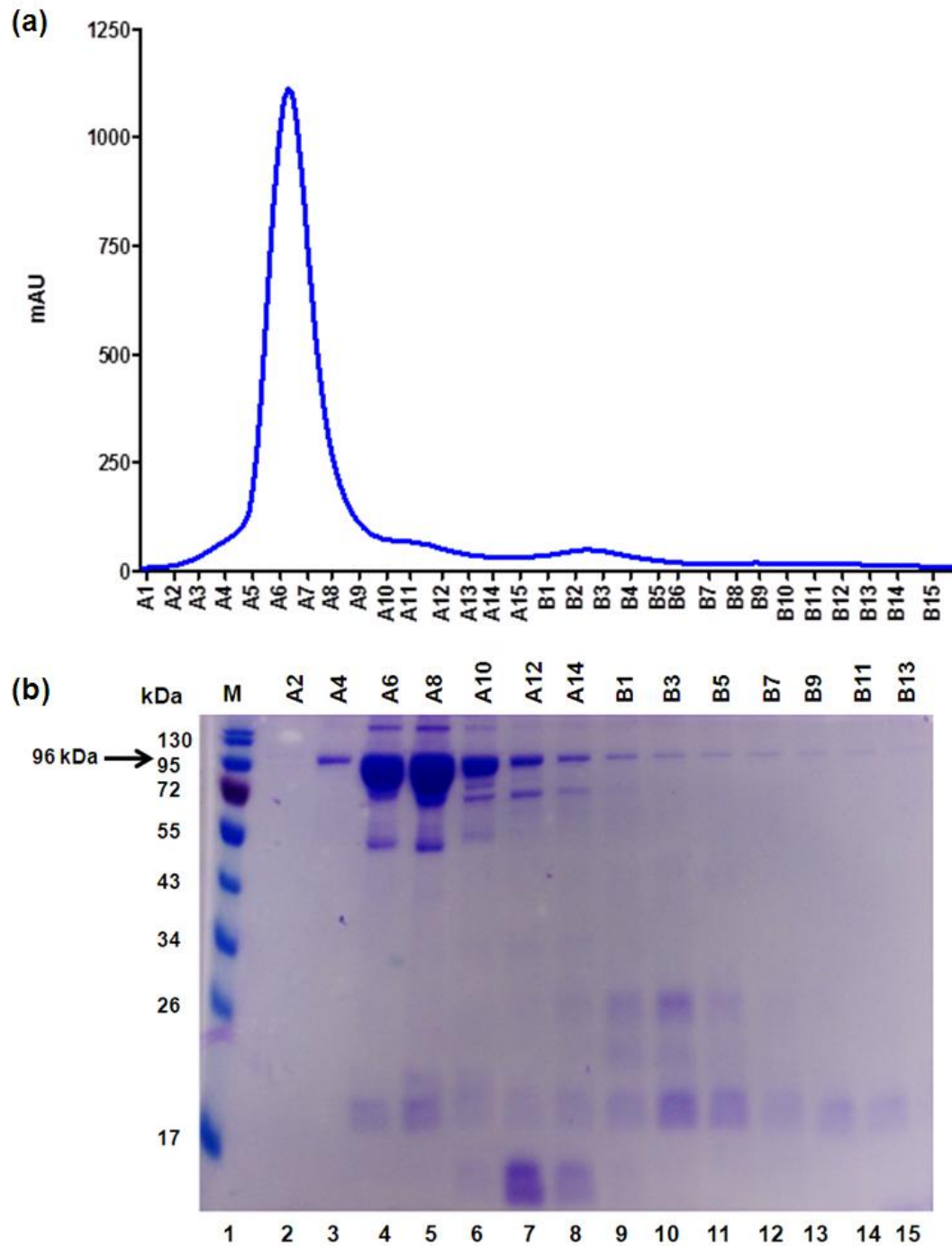




**Figure 4.11:** Purification of the D224N-5His-MBP using IMAC chromatography and analysis by SDS-PAGE and Western blot. (a) A typical chromatograph showing the eluted fractions after (i) 2<sup>nd</sup> round of IMAC, (ii) 1<sup>st</sup> round of IMAC. (b) SDS-PAGE and (c) western blot analysis of D224N-5His-MBP after IMAC. Lanes: (1) M = molecular weight ladder (kDa), (2) C = crude fraction, (3) SN = culture supernatant, (4) S = soluble fraction, (5) I = insoluble fraction, (6 – 10) E1 – E10 = eluted fractions and correspond to the chromatographs in panel (a).



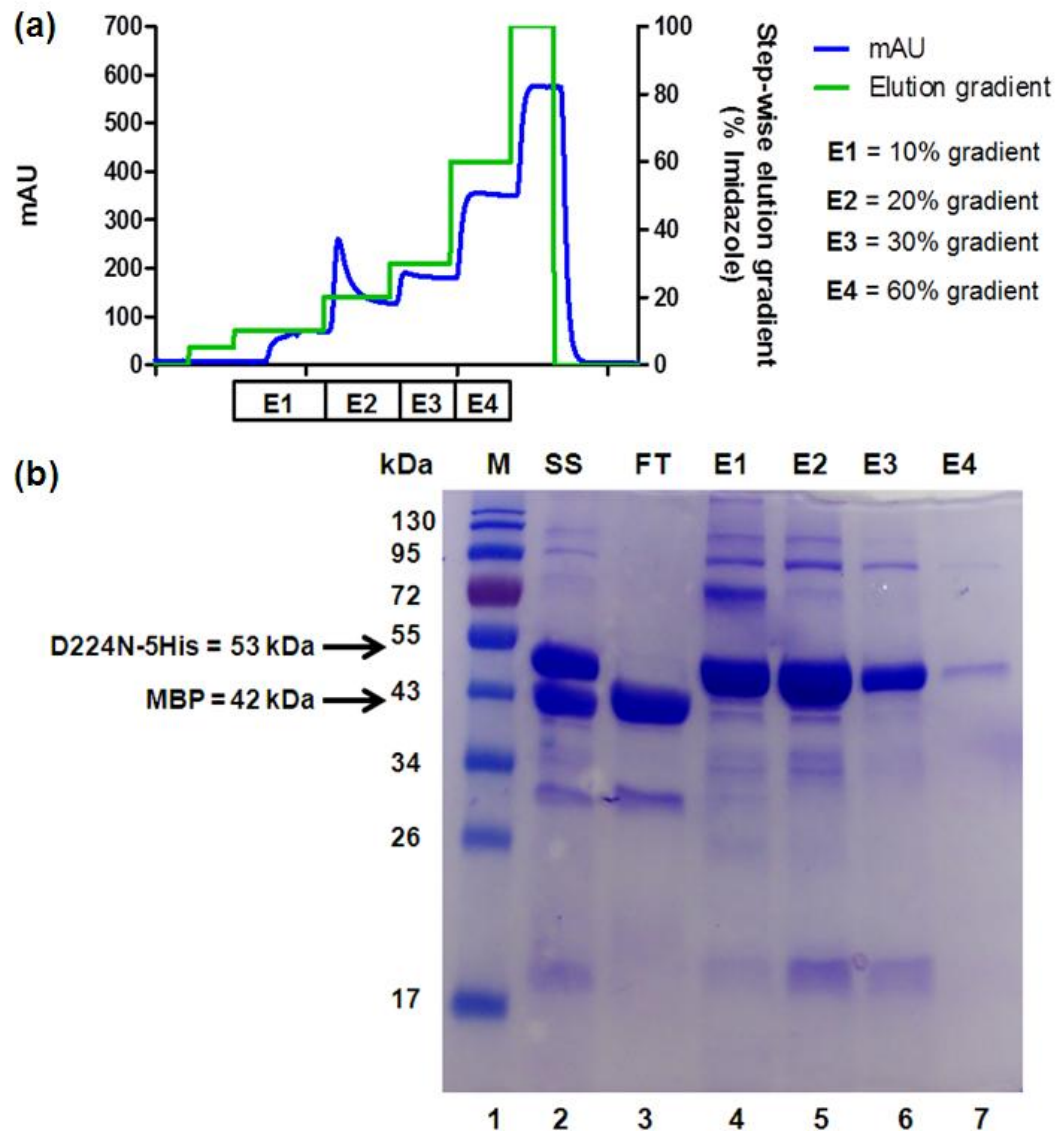
**Figure 4.12:** Purification of the D224N-5His-MBP using IMAC chromatography and analysis by SDS-PAGE and Western blot. (a) A typical chromatograph showing the eluted fractions after 3<sup>rd</sup> round of IMAC. (b) SDS-PAGE and (c) western blot analysis of D224N-5His-MBP after IMAC. Lanes: (1) M = molecular weight ladder (kDa), (2 – 6) E1 – E5 = eluted fractions and correspond to the chromatograph in panel (a).



**Figure 4.13:** Purification of the D224N-5His-MBP using SEC chromatography and analysis by SDS-PAGE. (a) A typical chromatograph showing the eluted fractions. (b) SDS-PAGE of D224N-5His-MBP after SEC. Lanes (1) M = molecular weight ladder (kDa), (2 – 15) each lane corresponds to an eluted fraction on the chromatograph in part (a).

#### 4.2.6 Cleavage of D224N-5His-MBP with Factor Xa

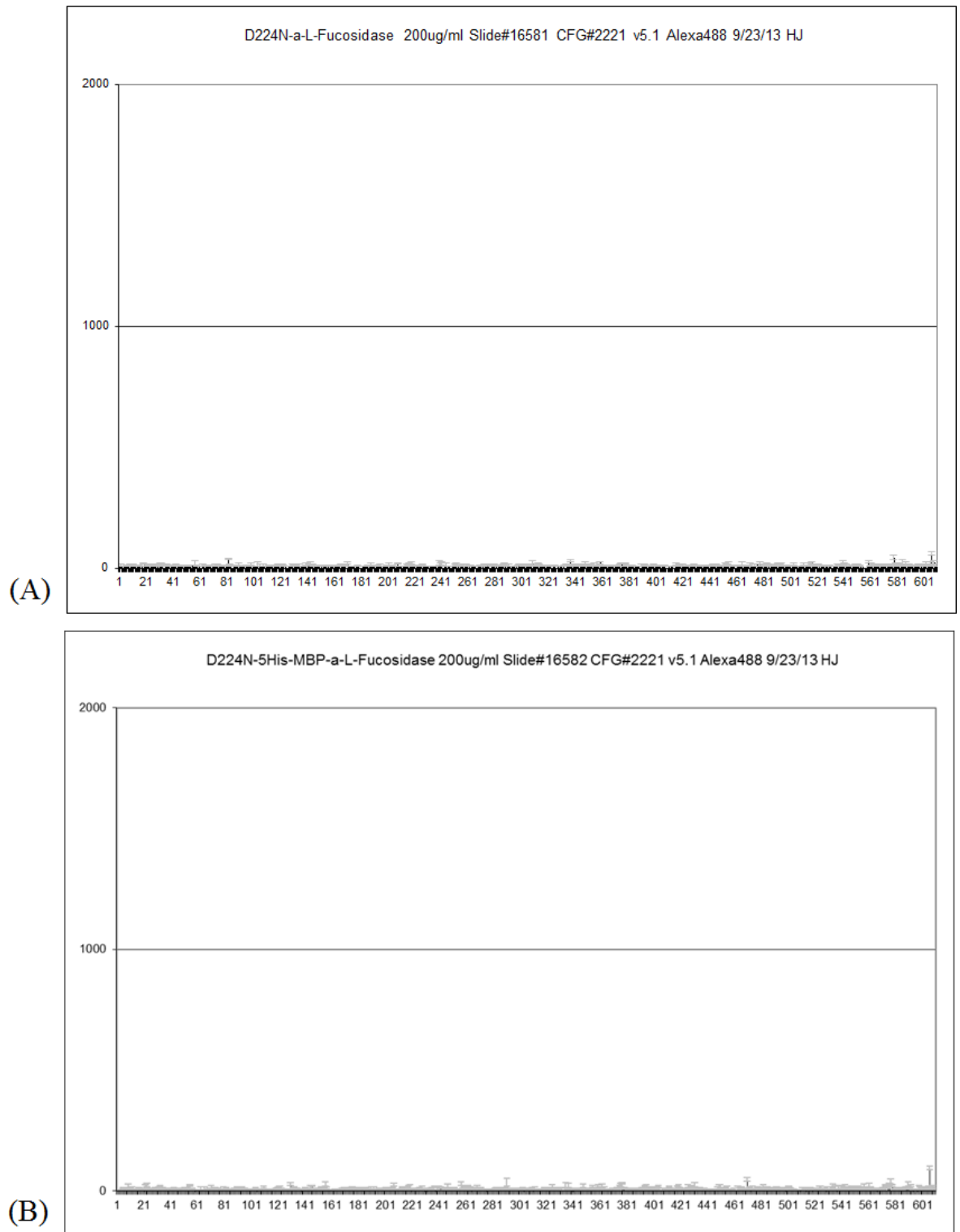
The factor Xa protease was used to cleave the MBP from the D224N-5His. Factor Xa recognises the four amino acid sequence Ile – Glu (Asp) – Gly – Arg, which is present between the MBP and D224N-5His, and cleaves after the arginine residue (Riggs 2001). The fusion protein was incubated with the factor Xa at a ratio of 50 µg fusion to 1 µg factor Xa. After incubation for 24 hours the cleavage reaction was analysed by SDS-PAGE to see if the cleavage had gone to completion. If the cleavage was not complete the reaction was incubated for a further 24 hours. The cleavage of the MBP from the D224N-5His resulted in two bands when visualised on an SDS-PAGE gel at 42 kDa and 53 kDa, corresponding to the MBP and D224N-5His respectively as shown in lane 2, in panel (b) in Figure 4.14. Separation of the MBP from the D224N-5His was done via IMAC and a typical chromatograph is shown in panel (a) in Figure 4.14. The MBP which has no affinity for the HisTrap column was found in the flow through as shown in lane 3, in panel (b) in Figure 4.14) while the D224N-5His bound to the column. A competitive step wise gradient with imidazole was used to elute the protein from the column and the eluted fractions were analysed by SDS-PAGE as shown in lanes 4 – 7, in panel (b) in Figure 4.14.



**Figure 4.14:** Separation of D224N-5His from MBP using IMAC chromatography and analysis by SDS-PAGE. (a) A typical chromatograph showing the eluted fractions after separation of the D224N-5His from MBP. (b) SDS-PAGE analysis of D224N-5His separation from MBP after IMAC. Lanes (1) M = molecular weight ladder (kDa), (2) SS = starting cleaved sample, (3) FT = flow through containing MBP, (4 – 7) E1 – E4 = eluted fractions containing D224N-5His and correspond to the chromatograph in panel (a).

#### 4.2.7 Glycan array screening

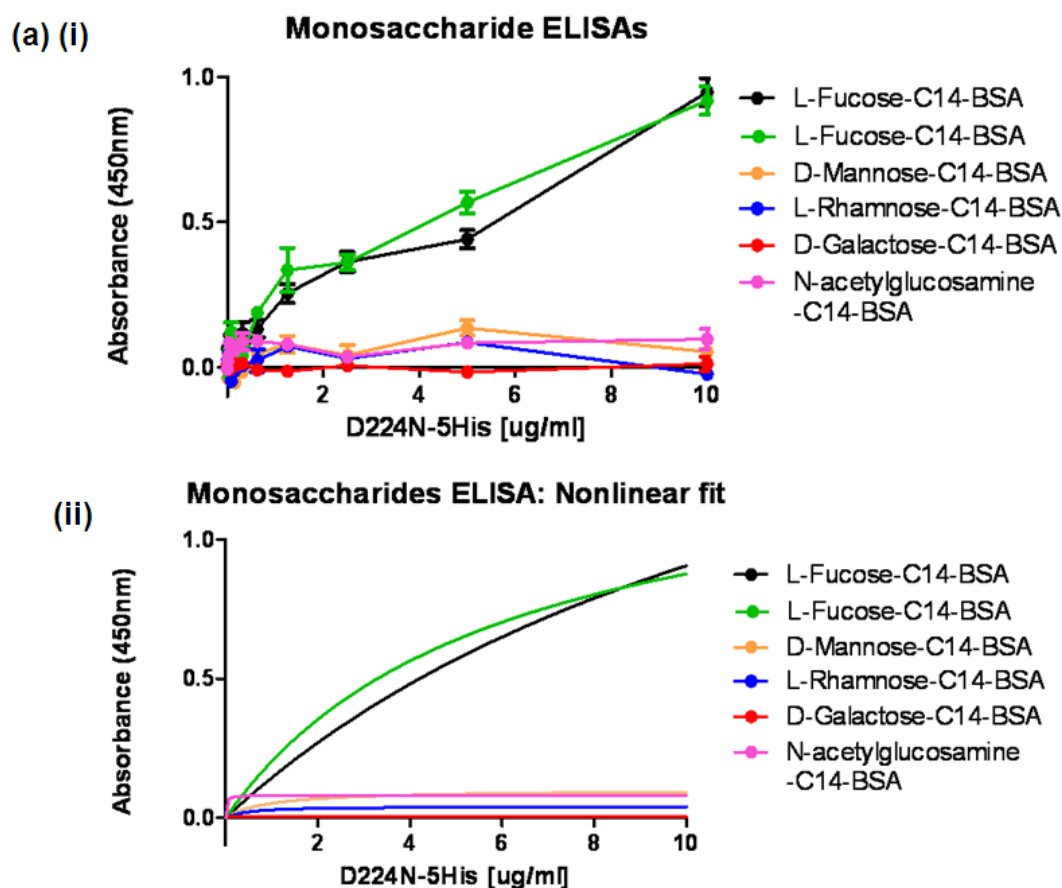
As the specificity of the D224N-5His  $\alpha$ -L-Fucosidase is not known, both the D224N-5His and the D224N-5His-MBP fusion proteins were screened against the glycan array, (Version 5.1) at the Consortium for Functional Glycomics (CFG, <http://www.functionalglycomics.org/>). This array consists of 610 glycans, both natural and synthetic that are attached via a number of different linkers on microscope slides. The D224N-5His and the D224N-5His-MBP fusion were screened at concentrations of 200  $\mu$ g/ml on the micro array, and were visualized via a fluorescently labelled anti-His tag antibody. Unfortunately, as shown in Figure 4.15 neither the D224N-5His nor the D224N-5His-MBP fusion protein showed appreciable binding to any of the glycans on the array (data included on CD-ROM). There are a number of reasons why neither sample bound to the array. It is possible that none of the 204 fucose-containing glycans were natural substrates for the fucosidase, and therefore did not bind to the inactive mutants. It is also possible that the affinity of the inactive mutants was simply too low for the binding to be detected. Alternatively, during the time taken for the proteins to arrive at the CFG, approximately 4 days, the samples may have degraded or otherwise become inactive. There are many other potential reasons for an inconclusive result. The conditions used during the screening of the proteins on the array such as protein or antibody concentrations may not have been optimal. The length and orientation of the linker used to attach the glycans to the chip can also affect the presentation of the glycans on the array leading to false negative results (Grant et al. 2014).



**Figure 4.15:** Graphical representation showing no binding by either (A) D224N-5His  $\alpha$ -L-Fucosidase or (B) D224N-5His-MBP fusion to the glycan array. The x-axis numbers correspond to the glycan numbering in Appendix IV, and the y-axis is the relative fluorescence units measured.

#### 4.2.8 Enzyme linked immunosorbent assay (ELISA)

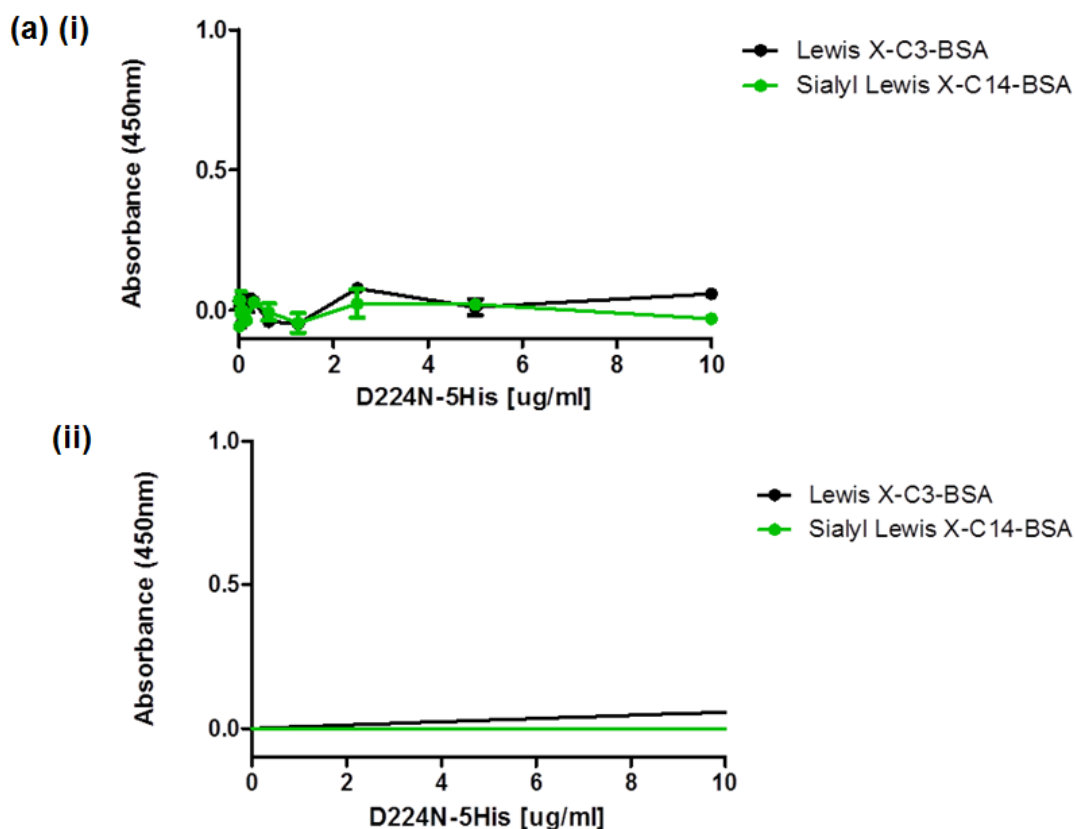
As there was no positive binding of the D224N-5His to any glycans on the array at the CFG, we decided to look for the binding of the D224N-5His mutant to various monosaccharides conjugated to BSA via a C14 linker using an ELISA assay. We used an indirect ELISA and have shown that the D224N-5His mutant binds to L-fucose, black and green circles in Figure 4.16, but not to L-rhamnose (blue circles), an epimer of fucose as shown in Figure 4.16. There was also no binding detected for the monosaccharides D-mannose (orange circles), D-galactose (red circles) or N-acetylglucosamine (pink circles). These results confirmed that the protein was active and bound specifically to fucose in comparison to the other monosaccharides tested.



**Figure 4.16:** ELISA assay testing binding of D224N-5His to various monosaccharides conjugated to BSA via a C14 linker. (a)(i) showing the raw data and (a)(ii) showing a non-linear fit of the data.



We are interested in studying the binding of fucosidase to Lewis x and sialyl Lewis x. Based on computational data carried out in our group, it has been predicted that the fucosidase will bind to Lewis x but not to the sialylated version, sialyl Lewis x. To test this we used an indirect ELISA to determine if the D224N-5His would bind to Lewis or sialyl Lewis x BSA conjugates. The sialyl Lewis x was conjugated to the BSA via a C14 linker while the Lewis x was conjugated via a C3 linker. As shown in Figure 4.17, there was no binding detected to the fucosidase to either the Lewis x or sialyl Lewis x. As the fucosidase was expected to bind the Lewis x, it is possible that the C3 linker which is shorter than a C14 linker may result in the fucosidase not binding to the lewis x. However the lack of binding detected for the sialyl Lewis x is in agreement with the computational data and as it was conjugated via a C14 linker like the monosaccharide conjugates, this is thought to be a true non-binding event.



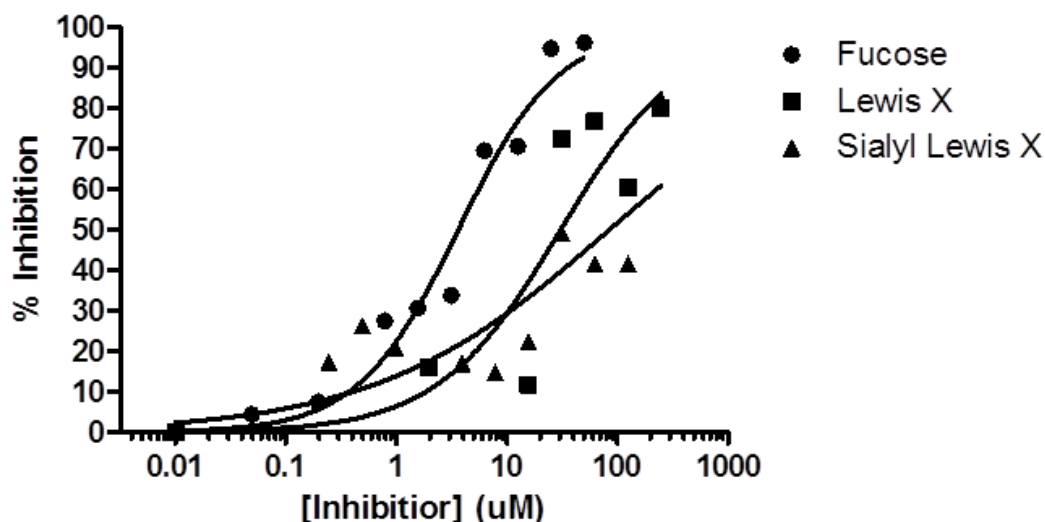
**Figure 4.17:** ELISA assay testing binding of D224N-5His to Lewis x and sialyl Lewis x conjugated to BSA via a C3 and C14 linker respectively. (a)(i) showing the raw data and (a)(ii) showing a non-linear fit of the data.

Due to the difference in linker length between the Lewis x and the sialyl Lewis x BSA conjugates, we also tried to determine binding for the fucosidase to biotinylated Lewis x and sialyl Lewis x using streptavidin coated plates. A 96-well plate precoated with streptavidin and preblocked was coated with biotinylated Lewis x and sialyl Lewis x at 5  $\mu\text{g/ml}$ . This was then incubated with the D224N-5His  $\alpha$ -L-Fucosidase and appropriate antibodies for detection. However, for each ELISA, the background values detected were high, and after background subtraction, the values were only within the noise region. This issue was initially thought to be a blocking problem, or experimental error. The ELISAs were repeated and tested with different blocking conditions, coating concentrations and a conjugated  $\alpha$ -penta-His horseradish peroxidase Ab. For all ELISAs, although done in triplicate, the measured absorbance values varied significantly, as did the background values. Subsequently, it was found that our goat  $\alpha$ -mouse horseradish peroxidase conjugated Ab was binding non-specifically to the ELISA plate. Since our Abs were binding non-specifically with the ELISA plate it was decided to examine binding using inhibition ELISAs and surface plasmon resonance (SPR) studies.

Inhibition ELISAs were carried out using (1) L-fucose, (2) Lewis x and (3) sialyl Lewis x as inhibitors. Plates were coated with L-Fucose-C14-BSA. A solution containing 50  $\mu\text{l}$  of D224N-5His  $\alpha$ -L-Fucosidase (20  $\mu\text{g/ml}$ ) was added to each well with 50  $\mu\text{l}$  of L-Fucose, Lewis x or sialyl Lewis x in various concentrations (0  $\mu\text{M}$  – 500  $\mu\text{M}$ ) to determine their potential to inhibit the binding of D224N-5His  $\alpha$ -L-Fucosidase to L-Fucose. The percentage inhibition for each inhibitor was determined and plotted against inhibitor concentration as shown in Figure 4.18 and from the best fit to the data the  $\text{IC}_{50}$  for each inhibitor was determined and is shown in Table 4.3.

**Table 4.3:** Inhibition data for D224N-5His  $\alpha$ -L-Fucosidase with inhibitors 1 – 3.

	<b>Inhibitor</b>	<b><math>\text{IC}_{50}</math></b>
<b>1</b>	L-Fucose	3.6 $\mu\text{M}$
<b>2</b>	Lewis x	30.6 $\mu\text{M}$
<b>3</b>	Sialyl lewis x	84.1 $\mu\text{M}$

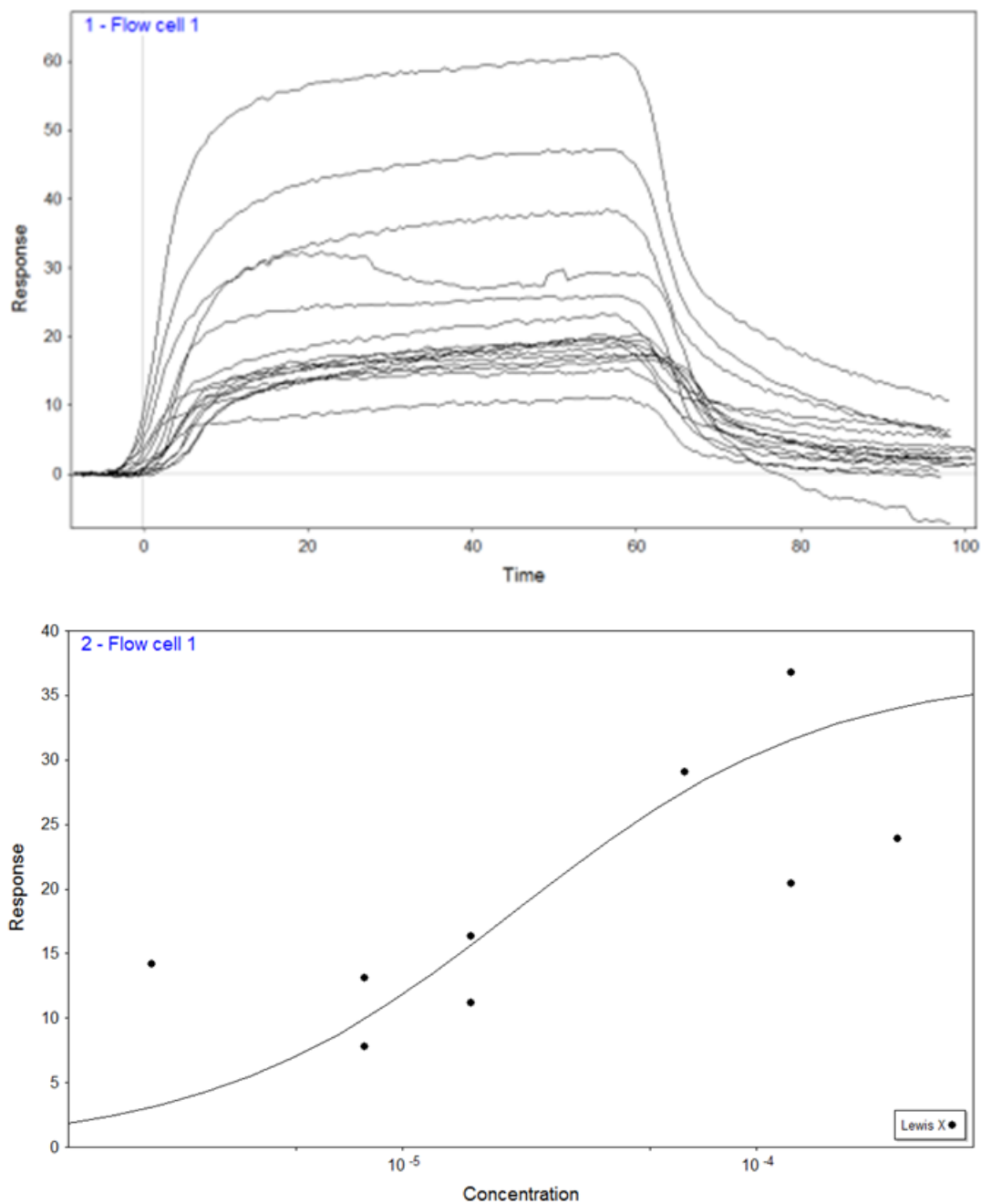


**Figure 4.18:** Inhibition ELISA assay of D224N-5His with fucose, Lewis x and sialyl Lewis x.  $IC_{50}$  values were determined from the curves.

L-Fucose was the best inhibitor with an  $IC_{50}$  value of  $3.6 \mu\text{M}$  which was 9- and 23-fold higher than D224N-5His  $\alpha$ -L-Fucosidase's affinity for Lewis x and sialyl Lewis x at  $30.6 \mu\text{M}$  and  $84.1 \mu\text{M}$  respectively (Table 4.3). The lower affinity of the  $\alpha$ -L-Fucosidase for sialyl Lewis x is expected as the sialic acid has been shown to clash in computational data in our group (unpublished).

#### 4.2.9 Surface plasmon resonance studies

To determine initial dissociation constants for the trisaccharide  $Le^x$  and tetrasaccharide  $sLe^x$ , the D224N-5His  $\alpha$ -L-Fucosidase was coated onto a dextran sensor chip. The  $Le^x$  and  $sLe^x$  saccharides were passed over the chip to obtain association and dissociation curves. The binding curve and fit for  $Le^x$  to D224N-5His  $\alpha$ -L-Fucosidase are shown in Figure 4.17. The  $Le^x$  was found to have a dissociation constant ( $K_D$ ) of  $19.1 \pm 7 \mu\text{M}$ . There was no measurable binding of the  $sLe^x$  to the D224N-5His  $\alpha$ -L-Fucosidase. This initial data is in agreement with the predicted computational data (unpublished) that suggests that the  $\alpha$ -L-Fucosidase is specific for  $Le^x$  and not  $sLe^x$ .



**Figure 4.19:** Surface plasmon resonance of D224N-5His binding to Lewis X ( $19.1 \pm 7 \mu\text{M}$ ) at equilibrium. Representative sensograms (top panels) and fits of the response at equilibrium (bottom panels) from the SPR binding assays.

### 4.3 Conclusions and Future Work

#### 4.3.1 Conclusions

The  $\alpha$ -L-Fucosidase from *Thermotoga maritima* has been cloned, expressed, purified and its binding preferences examined. Fucosidases are known to cleave non-reducing terminal fucose residues from larger glycans. This fucosidase is the closest bacterial relative to mammalian  $\alpha$ -L-Fucosidase, with 38% sequence identity (Sulzenbacher et al. 2004). The catalytic nucleophile of the  $\alpha$ -L-Fucosidase, aspartic acid residue 224 (Tarling et al. 2003), was mutated to alanine and asparagine residues to generate two inactive mutants, D224A and D224N respectively. The D224A mutant has been shown previously to have a 10000-fold reduction in activity in comparison to the wild-type enzyme (Tarling et al. 2003). Both mutants were expressed mainly as insoluble protein. Fusion of the D224N-5His mutant with MBP enabled soluble expression of the chimera protein. Subsequently, the MBP was cleaved and D224N-5His isolated via IMAC.

Although screening of both the D224N-5His and D224N-5His-MBP fusion proteins against the CFG glycan arrays failed to detect any appreciable binding, ELISA assays indicated that the D224N-5His bound to the L-fucose monosaccharide. We have also shown that fucosidase is specific for L-fucose in comparison to a number of other monosaccharides including L-rhamnose, D-mannose, D-galactose and N-acetylglucosamine where no binding was detected via ELISA. Binding preference to Lewis x and sialyl Lewis x was also examined via ELISA, where it was shown that there was no binding to either. Although there was no binding to Lewis x, this is thought to be due to the short length of the linker (C3-linker) in comparison to the C-14 linker that was used to conjugate the monosaccharides and sialyl Lewis x to BSA. It was not possible to determine if the fucosidase would bind to Lewis x via ELISA as it we could not source Lewis x conjugated to BSA with a C14 linker. Inhibition ELISA assays were carried out with L-fucose, Lewis x and sialyl Lewis x, with the fucosidase having the strongest affinity for fucose and weakest affinity for sialyl Lewis x. Subsequently, SPR experiments were performed to determine whether D224N-5His bound to Le<sup>x</sup> and sLe<sup>x</sup>, and to quantify any measurable dissociation constants for these ligands. For Le<sup>x</sup>, a  $K_D$  of  $19.1 \pm 7 \mu\text{M}$  was determined, which shows that D224N-5His has a ten-fold stronger affinity for Le<sup>x</sup> than have other

fucose-binding proteins, such as the lectins *Lotus tetragonolobus* A (225  $\mu\text{M}$ ) or *Aleuria aurantia* agglutinin, (220  $\mu\text{M}$ ) (Haselhorst et al. 2001). There was no measurable binding detected for sLe<sup>x</sup>, suggesting that sialylation blocks ligand binding, and that this fucosidase must therefore act prior to sialylation.

Recently the GH29  $\alpha$ -L-Fucosidases have been classified into two subfamilies, based on phylogenetic analysis. Members of the GH29-A family, which include both the human and bacterial (*T. maritima*)  $\alpha$ -L-Fucosidases, have more relaxed substrate specificity in comparison to  $\alpha$ -L-Fucosidases in the GH29-B family, including those from *Streptomyces* species. and *Bifidobacterium bifidum* which act on either  $\alpha$ 1-3 or  $\alpha$ 1-4 linked fucose (Sakurama et al. 2012). So far, we have determined that D224N-5His, will bind to Le<sup>x</sup> ( $\alpha$ 1-3 linked fucose) but its broader substrate specificity is not fully known.

The specificity of D224N-5His for Le<sup>x</sup> over sLe<sup>x</sup> suggests that this inactive mutant of the fucosidase might be useful as a reagent for detecting the presence of Le<sup>x</sup> on cell surfaces. Lewis antigens are present on normal cells, but the over expression of them can be markers of diseases such as cancer. Le Pendu *et al.* have reviewed the overexpression of the Lewis antigens; Le<sup>a</sup>, Le<sup>b</sup>, Le<sup>x</sup> and Le<sup>y</sup> in a number of different cancers including lung, thyroid, bladder and ovarian (Le Pendu et al. 2001). In addition, gastric colonisation by *Helicobacter pylori* can in some cases lead to gastritis, ulcers and gastric cancer (Kusters et al. 2006). For adhesion to the human gastric epithelium cells, *H. pylori* binds to Le<sup>b</sup> through the blood group antigen-binding adhesin (BabA) (Ilver et al. 1998; Boren et al. 1993). The Lewis antigens Le<sup>a</sup>, Le<sup>b</sup>, Le<sup>x</sup> and Le<sup>y</sup> could therefore also be interesting targets for the development of a high affinity anti-adhesin reagent, perhaps based on D224N-5His.

### 4.3.2 *Future Work*

We are interested in studying the interactions between  $\alpha$ -L-Fucosidase and the Lewis antigens Le<sup>a</sup>, Le<sup>b</sup>, Le<sup>x</sup> and Le<sup>y</sup>. The linkages that should be tested are Le<sup>a</sup> ( $\alpha$ 1-4), Le<sup>b</sup> ( $\alpha$ 1-2/ $\alpha$ 1-4), Le<sup>x</sup> ( $\alpha$ 1-3) and Le<sup>y</sup> ( $\alpha$ 1-2/ $\alpha$ 1-4). This could be tested using inhibition ELISA assays to determine if there was inhibition of  $\alpha$ -L-fucosidase binding to L-fucose and also via SPR. Screening of the  $\alpha$ -L-fucosidase against a glycans array is another method that could be used to determine specificity. This would allow for the  $\alpha$ -L-fucosidase binding specificity to be examined against a much larger number of glycan structures. After the specificity of the fucosidase is known, it could potentially be engineered via site-saturation mutagenesis and phage display to generate a library of proteins, which could be screened for higher affinity and specificity for a target of interest.

## References

- A. Varki; J.B. Lowe, 2009. Biological Roles of Glycans. In A. Varki et al., eds. *Essentials of Glycobiology*. Cold Spring Harbor (NY): Cold Spring Harbor Laboratory Press, pp. 75 – 88. Available at: <http://www.ncbi.nlm.nih.gov/books/NBK1897/>.
- Abd Hamid, U.M. et al., 2008. A strategy to reveal potential glycan markers from serum glycoproteins associated with breast cancer progression. *Glycobiology*, 18(12), pp.1105–1118. Available at: <http://www.ncbi.nlm.nih.gov/pubmed/18818422>.
- Arnold, J.N. et al., 2011. Novel glycan biomarkers for the detection of lung cancer. *Journal of Proteome Research*, 10(4), pp.1755–1764. Available at: <http://www.ncbi.nlm.nih.gov/pubmed/21214223>.
- Artimo, P. et al., 2012. ExPASy: SIB bioinformatics resource portal. *Nucleic Acids Research*, 40 (W1), pp.W597–W603. Available at: <http://nar.oxfordjournals.org/content/40/W1/W597.abstract>.
- Ashida, H. et al., 2009. Two distinct alpha-L-fucosidases from *Bifidobacterium bifidum* are essential for the utilization of fucosylated milk oligosaccharides and glycoconjugates. *Glycobiology*, 19(9), pp.1010–1017. Available at: <http://ovidsp.ovid.com/ovidweb.cgi?T=JS&NEWS=N&PAGE=fulltext&AN=0002513-200909000-00012&D=ovftj>.
- De Bernardez Clark, E., 1998. Refolding of recombinant proteins. *Current Opinion in Biotechnology*, 9(2), pp.157–163. Available at: <http://www.sciencedirect.com/science/article/pii/S0958166998801092>.
- Bolanos-Garcia, V.M. & Davies, O.R., 2006. Structural analysis and classification of native proteins from *E. coli* commonly co-purified by immobilised metal affinity chromatography. *Biochimica et Biophysica Acta (BBA) - General Subjects*, 1760(9), pp.1304–1313. Available at: <http://www.sciencedirect.com/science/article/pii/S0304416506000894>.
- Boren, T. et al., 1993. Attachment of *Helicobacter pylori* to human gastric epithelium mediated by blood group antigens. *Science*, 262 (5141), pp.1892–1895. Available at: <http://www.sciencemag.org/content/262/5141/1892.abstract>.
- Brazil, J.C. et al., 2013.  $\alpha$ 3/4 Fucosyltransferase 3–Dependent Synthesis of Sialyl Lewis A on CD44 Variant Containing Exon 6 Mediates Polymorphonuclear Leukocyte Detachment from Intestinal Epithelium during Transepithelial Migration. *The Journal of Immunology*. Available at: <http://www.jimmunol.org/content/early/2013/09/25/jimmunol.1301307.abstract>.
- Cazet, A. et al., 2010. Tumour-associated carbohydrate antigens in breast cancer. *Breast cancer research*: BCR, 12(3), p.204. Available at: <http://breast-cancer-research.com/content/12/3/204> [Accessed October 20, 2013].



- Croce, M. et al., 2007. Lewis x is highly expressed in normal tissues: A comparative immunohistochemical study and literature revision. *Pathology & Oncology Research*, 13(2), pp.130–138. Available at: <http://dx.doi.org/10.1007/BF02893488>.
- Cummings, R.D. & McEver, R.P., 2009. C-type Lectins. In A. Varki et al., eds. *Essentials of Glycobiology*. Cold Spring Harbor (NY): Cold Spring Harbor Laboratory Press. Available at: <http://www.ncbi.nlm.nih.gov/books/NBK1943/>.
- Dam, T.K. et al., 2005. Galectins Bind to the Multivalent Glycoprotein Asialofetuin with Enhanced Affinities and a Gradient of Decreasing Binding Constants†. *Biochemistry*, 44(37), pp.12564–12571. Available at: <http://dx.doi.org/10.1021/bi051144z>.
- Esposito, D. & Chatterjee, D.K., 2006. Enhancement of soluble protein expression through the use of fusion tags. *Current Opinion in Biotechnology*, 17(4), pp.353–358. Available at: <http://www.sciencedirect.com/science/article/pii/S0958166906000875>.
- Fox, J.D. & Waugh, D.S., 2003. Maltose-binding protein as a solubility enhancer. *Methods In Molecular Biology Clifton Nj*, 205, pp.99–117. Available at: <http://www.ncbi.nlm.nih.gov/pubmed/12491882>.
- Ghazarian, H., Idoni, B. & Oppenheimer, S.B., 2011. A glycobiology review: carbohydrates, lectins and implications in cancer therapeutics. *Acta histochemica*, 113(3), pp.236–247. Available at: <http://europepmc.org/abstract/MED/20199800>.
- Glynou, K., Ioannou, P.C. & Christopoulos, T.K., 2003. One-step purification and refolding of recombinant photoprotein aequorin by immobilized metal-ion affinity chromatography. *Protein Expression and Purification*, 27(2), pp.384–390. Available at: <http://www.scopus.com/inward/record.url?eid=2-s2.0-0037297123&partnerID=40&md5=1616e92cd1ada75dd71ebef6fa202c77>.
- Gout, S., Tremblay, P.-L. & Huot, J., 2008. Selectins and selectin ligands in extravasation of cancer cells and organ selectivity of metastasis. *Clinical & Experimental Metastasis*, 25(4), pp.335–344. Available at: <http://dx.doi.org/10.1007/s10585-007-9096-4>.
- Grant, O.C. et al., 2014. Presentation, presentation, presentation! Molecular-level insight into linker effects on glycan array screening data. *Glycobiology*, 24 (1), pp.17–25. Available at: <http://glycob.oxfordjournals.org/content/24/1/17.abstract>.
- Hansson, G.C. & Zopf, D., 1985. Biosynthesis of the cancer-associated sialyl-Lea antigen. *Journal of Biological Chemistry*, 260 (16), pp.9388–9392. Available at: <http://www.jbc.org/content/260/16/9388.abstract>.
- Haselhorst, T., Weimar, T. & Peters, T., 2001. Molecular recognition of sialyl Lewis(x) and related saccharides by two lectins. *Journal of the American*

- Chemical Society*, 123(43), pp.10705–10714. Available at:  
[http://www.ncbi.nlm.nih.gov/entrez/query.fcgi?cmd=Retrieve&db=PubMed&dopt=Citation&list\\_uids=11674003](http://www.ncbi.nlm.nih.gov/entrez/query.fcgi?cmd=Retrieve&db=PubMed&dopt=Citation&list_uids=11674003).
- Henrissat, B., 1991. A classification of glycosyl hydrolases based on amino acid sequence similarities. *Biochemical Journal*, 280(Pt 2), pp.309–316. Available at:  
<http://www.pubmedcentral.nih.gov/articlerender.fcgi?artid=1130547&tool=pmc&entrez&rendertype=abstract>.
- Holmes, E.H., Ostrander, G.K. & Hakomori, S., 1986. Biosynthesis of the sialyl-Lex determinant carried by type 2 chain glycosphingolipids (IV3NeuAcIII3FucnLc4, VI3NeuAcV3FucnLc6, and VI3NeuAcIII3V3Fuc2nLc6) in human lung carcinoma PC9 cells. *Journal of Biological Chemistry*, 261 (8), pp.3737–3743. Available at:  
<http://www.jbc.org/content/261/8/3737.abstract>.
- Ilver, D. et al., 1998. Helicobacter pylori Adhesin Binding Fucosylated Histo-Blood Group Antigens Revealed by Retagging. *Science*, 279 (5349), pp.373–377. Available at: <http://www.sciencemag.org/content/279/5349/373.abstract>.
- Imber, M., Glasgow, L. & Pizzo, S., 1982. Purification of an almond emulsin fucosidase on Cibacron blue-sepharose and demonstration of its activity toward fucose-containing glycoproteins. *J. Biol. Chem.*, 257(14), pp.8205–8210. Available at: <http://www.jbc.org/cgi/content/long/257/14/8205> [Accessed November 23, 2012].
- Johnson, S.W. & Alhadeff, J.A., 1991. Mammalian alpha-L-fucosidases. *Comparative Biochemistry And Physiology B Comparative Biochemistry*, 99(3), pp.479–488.
- Kapust, R.B. & Waugh, D.S., 1999. Escherichia coli maltose-binding protein is uncommonly effective at promoting the solubility of polypeptides to which it is fused. *Protein Science*, 8(8), pp.1668–1674. Available at:  
<http://www.pubmedcentral.nih.gov/articlerender.fcgi?artid=2144417&tool=pmc&entrez&rendertype=abstract>.
- Katayama, T. et al., 2004. Molecular cloning and characterization of Bifidobacterium bifidum 1,2-alpha-L-fucosidase (AfcA), a novel inverting glycosidase (Glycoside hydrolase family 95). *Journal Of Bacteriology*, 186(15), pp.4885–4893.
- Kitagawa, H. & Paulson, J.C., 1993. Cloning and Expression of Human Galβ1,3(4)GlcNAc α2,3-Sialyltransferase. *Biochemical and Biophysical Research Communications*, 194(1), pp.375–382. Available at:  
<http://www.sciencedirect.com/science/article/pii/S0006291X83718309>.
- Kobata, A., 1982. α-1-fucosidases from almond emulsin. In V. G. B. T.-M. in Enzymology, ed. *Complex Carbohydrates Part D*. Academic Press, pp. 625–

631. Available at:

<http://www.sciencedirect.com/science/article/pii/S0076687982830619>.

Kusters, J.G., van Vliet, A.H.M. & Kuipers, E.J., 2006. Pathogenesis of *Helicobacter pylori* Infection. *Clinical Microbiology Reviews* , 19 (3 ), pp.449–490.

Available at: <http://cmr.asm.org/content/19/3/449.abstract>.

Kyselova, Z. et al., 2008. Breast Cancer Diagnosis and Prognosis through Quantitative Measurements of Serum Glycan Profiles. *Clinical Chemistry* , 54 (7 ), pp.1166–1175. Available at:

<http://www.clinchem.org/content/54/7/1166.abstract>.

Listinsky, J.J., Siegal, G.P. & Listinsky, C.M., 2011. The emerging importance of  $\alpha$ -L-fucose in human breast cancer: a review. *American journal of translational research*, 3(4), pp.292–322. Available at:

<http://www.pubmedcentral.nih.gov/articlerender.fcgi?artid=3158734&tool=pmc&entrez&rendertype=abstract>.

Magnani, J.L., 2004. The discovery, biology, and drug development of sialyl Lea and sialyl Lex. *Archives of Biochemistry and Biophysics*, 426(2), pp.122–131.

Available at: <http://www.ncbi.nlm.nih.gov/pubmed/15158662>.

Malý, P. et al., 1996. The  $\alpha(1,3)$ Fucosyltransferase Fuc-TVII Controls Leukocyte Trafficking through an Essential Role in L-, E-, and P-selectin Ligand Biosynthesis. *Cell*, 86(4), pp.643–653. Available at:

<http://linkinghub.elsevier.com/retrieve/pii/S0092867400801373>.

Manimala, J.C. et al., 2007. High-throughput carbohydrate microarray profiling of 27 antibodies demonstrates widespread specificity problems. *Glycobiology* , 17 (8 ), p.17C–23C. Available at:

<http://glycob.oxfordjournals.org/content/17/8/17C.abstract>.

Mayer, M. & Buchner, J., 2004. Refolding of inclusion body proteins. *Methods in Molecular Medicine*, 94(3), pp.239–254. Available at:

<http://www.ncbi.nlm.nih.gov/pubmed/14959834>.

Müller, S. & Hanisch, F.-G., 2002. Recombinant MUC1 Probe Authentically Reflects Cell-specific O-Glycosylation Profiles of Endogenous Breast Cancer Mucin: HIGH DENSITY AND PREVALENT CORE 2-BASED GLYCOSYLATION . *Journal of Biological Chemistry* , 277 (29 ), pp.26103–26112. Available at: <http://www.jbc.org/content/277/29/26103.abstract>.

Nallamsetty, S. et al., 2005. Gateway vectors for the production of combinatorially-tagged His6-MBP fusion proteins in the cytoplasm and periplasm of *Escherichia coli*. *Protein Science*, 14(12), pp.2964–2971. Available at:

<http://www.pubmedcentral.nih.gov/articlerender.fcgi?artid=2253240&tool=pmc&entrez&rendertype=abstract>.

Narita, T. et al., 1993. Association of expression of blood group-related carbohydrate antigens with prognosis in breast cancer. *Cancer*, 71(10), pp.3044–3053.

Available at: [http://dx.doi.org/10.1002/1097-0142\(19930515\)71:10<3044::AID-CNCR2820711026>3.0.CO](http://dx.doi.org/10.1002/1097-0142(19930515)71:10<3044::AID-CNCR2820711026>3.0.CO).

- Natsuka, S. et al., 1994. Molecular cloning of a cDNA encoding a novel human leukocyte alpha-1,3-fucosyltransferase capable of synthesizing the sialyl Lewis x determinant. *Journal of Biological Chemistry*, 269 (24), pp.16789–16794. Available at: <http://www.jbc.org/content/269/24/16789.abstract>.
- Okajima, T. et al., 1999. Molecular Cloning of a Novel  $\alpha$ 2,3-Sialyltransferase (ST3Gal VI) That Sialylates Type II Lactosamine Structures on Glycoproteins and Glycolipids. *Journal of Biological Chemistry*, 274 (17), pp.11479–11486. Available at: <http://www.jbc.org/content/274/17/11479.abstract>.
- Palmer, I. & Wingfield, P.T., 2004. Preparation and extraction of insoluble (inclusion-body) proteins from Escherichia coli. *Current protocols in protein science editorial board John E Coligan et al*, Chapter 6, p.Unit 6.3. Available at: <http://www.ncbi.nlm.nih.gov/pubmed/18429271>.
- Le Pendu, J. et al., 2001. ABH and Lewis histo-blood group antigens in cancer. *APMIS*, 109(1), pp.9–26. Available at: <http://dx.doi.org/10.1111/j.1600-0463.2001.tb00011.x>.
- Pryor, K.D. & Leiting, B., 1997. High-Level Expression of Soluble Protein in Escherichia coli Using a His6-Tag and Maltose-Binding-Protein Double-Affinity Fusion System. *Protein Expression and Purification*, 10(3), pp.309–319. Available at: <http://www.sciencedirect.com/science/article/pii/S1046592897907592>.
- Pusztai, A. et al., 1988. Isolation of soybean trypsin inhibitors by affinity chromatography on anhydrotrypsin-Sepharose 4B. *Analytical Biochemistry*, 172(1), pp.108–112. Available at: <http://www.sciencedirect.com/science/article/pii/0003269788904186> [Accessed February 9, 2014].
- Ravn, V. & Dabelsteen, E., 2000. Tissue distribution of histo-blood group antigens. *APMIS*, 108(1), pp.1–28. Available at: <http://dx.doi.org/10.1034/j.1600-0463.2000.d01-1.x>.
- Renkonen, J., Paavonen, T. & Renkonen, R., 1997. Endothelial and epithelial expression of sialyl Lewis x and sialyl Lewis a in lesions of breast carcinoma. *International Journal of Cancer*, 74(3), pp.296–300. Available at: [http://dx.doi.org/10.1002/\(SICI\)1097-0215\(19970620\)74:3<296::AID-IJC11>3.0.CO](http://dx.doi.org/10.1002/(SICI)1097-0215(19970620)74:3<296::AID-IJC11>3.0.CO).
- Riggs, P., 2001. Expression and purification of maltose-binding protein fusions. *Current protocols in molecular biology edited by Frederick M Ausubel et al*, Chapter 16(1994), p.Unit 16.6. Available at: <http://www.pubmedcentral.nih.gov/articlerender.fcgi?artid=2494979&tool=pmc-entrez&rendertype=abstract>.

- Riggs, P., 2000. Expression and purification of recombinant proteins by fusion to maltose-binding protein. *Molecular Biotechnology*, 15(1), pp.51–63. Available at: <http://dx.doi.org/10.1385/MB:15:1:51>.
- Routzahn, K. & Waugh, D., 2002. Differential effects of supplementary affinity tags on the solubility of MBP fusion proteins. *Journal of Structural and Functional Genomics*, 2(2), pp.83–92. Available at: <http://dx.doi.org/10.1023/A:1020424023207>.
- Sachdev, D. & Chirgwin, J.M., 1998a. Order of Fusions between Bacterial and Mammalian Proteins Can Determine Solubility in *Escherichia coli*. *Biochemical and Biophysical Research Communications*, 244(3), pp.933–937. Available at: <http://www.sciencedirect.com/science/article/pii/S0006291X98983656>.
- Sachdev, D. & Chirgwin, J.M., 1998b. Solubility of Proteins Isolated from Inclusion Bodies Is Enhanced by Fusion to Maltose-Binding Protein or Thioredoxin. *Protein Expression and Purification*, 12(1), pp.122–132. Available at: <http://www.sciencedirect.com/science/article/pii/S1046592897908263>.
- Sakurama, H. et al., 2012. Differences in the Substrate Specificities and Active-Site Structures of Two  $\alpha$ -L-Fucosidases (Glycoside Hydrolase Family 29) from *Bacteroides thetaiotaomicron*. *Bioscience, Biotechnology, and Biochemistry*, 76(5), pp.1022–1024.
- Saldova, R. et al., 2007. Ovarian cancer is associated with changes in glycosylation in both acute-phase proteins and IgG. *Glycobiology*, 17(12), pp.1344–1356. Available at: <http://www.ncbi.nlm.nih.gov/pubmed/17884841>.
- Sano, M., Hayakawa, K. & Kato, I., 1992. Purification and characterization of alpha-L-fucosidase from *Streptomyces* species. *The Journal of biological chemistry*, 267(3), pp.1522–7. Available at: <http://www.ncbi.nlm.nih.gov/pubmed/1730698>.
- Sasaki, K. et al., 1994. Expression cloning of a novel alpha 1,3-fucosyltransferase that is involved in biosynthesis of the sialyl Lewis x carbohydrate determinants in leukocytes. *Journal of Biological Chemistry*, 269 (20), pp.14730–14737. Available at: <http://www.jbc.org/content/269/20/14730.abstract>.
- Schwarzer, D. et al., 2009. Proteolytic Release of the Intramolecular Chaperone Domain Confers Processivity to Endosialidase F. *Journal of Biological Chemistry*, 284 (14), pp.9465–9474. Available at: <http://www.jbc.org/content/284/14/9465.abstract>.
- Scudder, P. et al., 1990. The isolation by ligand affinity chromatography of a novel form of alpha-L-fucosidase from almond. *J. Biol. Chem.*, 265(27), pp.16472–16477. Available at: <http://www.jbc.org/cgi/content/long/265/27/16472> [Accessed November 24, 2012].

- Sulzenbacher, G. et al., 2004. Crystal structure of *Thermotoga maritima* alpha-L-fucosidase. Insights into the catalytic mechanism and the molecular basis for fucosidosis. *The Journal of Biological Chemistry*, 279(13), pp.13119–13128.
- Tarling, C.A. et al., 2003. Identification of the catalytic nucleophile of the family 29 alpha-L-fucosidase from *Thermotoga maritima* through trapping of a covalent glycosyl-enzyme intermediate and mutagenesis. *The Journal of Biological Chemistry*, 278(48), pp.47394–47399. Available at: <http://www.jbc.org/cgi/content/abstract/278/48/47394>.
- Varki, A. et al., 2009. Discovery and classification of glycan-binding proteins. In A. Varki et al., eds. *Essentials of Glycobiology*. Cold Spring Harbor Laboratory Press, pp. 375 – 386.
- De Vries, T., Knegt, R.M.A., et al., 2001. Fucosyltransferases: structure/function studies. *Glycobiology*, 11 (10), p.119R–128R. Available at: <http://glycob.oxfordjournals.org/content/11/10/119R.abstract>.
- De Vries, T., Storm, J., et al., 2001. Production of soluble human  $\alpha$ 3-fucosyltransferase (FucT VII) by membrane targeting and in vivo proteolysis. *Glycobiology*, 11 (9), pp.711–717. Available at: <http://glycob.oxfordjournals.org/content/11/9/711.abstract>.
- Weis, W.I. & Drickamer, K., 1996. Structural Basis of Lectin-Carbohydrate Recognition. *Annual Review of Biochemistry*, 65(1), pp.441–473. Available at: <http://dx.doi.org/10.1146/annurev.bi.65.070196.002301>.
- Werner, M.H. et al., 1994. Refolding proteins by gel filtration chromatography. *FEBS Letters*, 345(2–3), pp.125–130. Available at: <http://www.sciencedirect.com/science/article/pii/0014579394004013>.
- Zale, S.E. & Klibanov, A.M., 1986. Why does ribonuclease irreversibly inactivate at high temperatures? *Biochemistry*, 25(19), pp.5432–5444. Available at: <http://dx.doi.org/10.1021/bi00367a014>.

## Chapter 5: General Conclusions

We were interested in a number of different carbohydrate-binding proteins including three scFvs specific for the same epitope on the cell surface of *C. albicans* and an inactive carbohydrate-processing enzyme. The aim of the project was to express, purify and characterize the binding specificities of these different carbohydrate binding proteins.

An IgG3 mAb, C3.1, was previously found to be specific for the same  $\beta$ -1,2-mannan epitope on the cell surface of *C. albicans* as an IgM, B6.1. These two antibodies differed by only six amino acid residues in the variable heavy chain. As well as differing by only six amino acids, these antibodies are unique due to their higher affinity for smaller di- and trisaccharides over larger tetra- to hexasaccharides (Nitz et al. 2002). We were interested in the effect these differences in amino acids had on the binding preference of the antibodies. Of the six amino acids, there are four mutations that occur in the framework regions, which are usually considered the scaffold region of an antibody. These regions display the complementary determining regions which are responsible for antigen binding. The other two mutations occur in the complementary determining region 3, which has been shown previously to contribute the most to antigen binding (Wilson & Stanfield 1994).

To study this, we engineered a single-chain variable fragment antibody of the C3.1 based on the variable heavy and light chains of the C3.1 IgG3 mAb. This scFv was then used as template DNA to generate the B6.1 and S100R scFvs via site-directed mutagenesis, along with a number of mutants with different point mutations. The C3.1, B6.1 and S100R scFvs were all expressed in *E. coli* and purified using IMAC and SEC, with their purity determined with SDS-PAGE. The scFvs were all present as a double band on SDS-PAGE, and this is consistent with the presence of a pelB leader sequence, although this has not been confirmed directly. To determine if the scFvs were active, ELISA assays were used to show that the three scFvs bound to the cell wall extract of *C. albicans*. We used SPR to study the affinity of the scFvs for di-, tri- and tetra-  $\beta$ 1,2-mannosides. The results of the C3.1 scFv have been published previously by our group and the scFv showed a similar trend to ELSIA  $IC_{50}$  data, with stronger affinities for smaller saccharides. The S100R scFv had its strongest affinity for the tri- and tetrasaccharide, and its lowest affinity for the

disaccharide. The S100R scFv mutation appeared to favour the slightly larger tri- and tetrasaccharide over the disaccharide. Interestingly, the S100R mutation was present in the variable heavy, FWR3 region, which is generally considered as a scaffold region, and not involved as much in antigen binding. This residue however is close to the variable heavy, CDR3 region, which contribute the most to antigen binding. The B6.1 scFv showed a similar trend to the C3.1 scFv and S100R scFv in having a strong affinity for the trisaccharide, although it was not possible to test it with the di- or tetrasaccharide. Unlike the B6.1 IgM which had a 2-fold lower affinity for the trisaccharide in comparison to the C3.1 IgG3, both the B6.1 scFv and C3.1 scFvs had similar affinities for the trisaccharide,  $18.9 \pm 3.0 \mu\text{M}$  and  $18.0 \pm 0.3 \mu\text{M}$  respectively.

It would be interesting to study the reason the scFvs are all present as double bands on SDS-PAGE gels, as well as detection of both bands on western blots with both an anti-His and anti-myc tag antibodies. All SDS-PAGE analysis was carried out on 12% non-reducing gels, so to determine if the scFvs are folded correctly could be determined by running a reducing SDS-PAGE gel. If this resulted in a single band on the gel, it would be suggestive of incorrectly folded protein. However, if both bands were still present in a reducing gel, it would indicate that there was an alternative reason for the presence of the two bands. As the scFvs all elute from the size exclusion column at a volume in agreement with the presence of monomeric scFvs, there may be a different reason for the double bands observed. The scFvs were found in the culture supernatant in *E. coli* HB2151 cells when induction is carried out for prolonged periods. This lengthy induction period may cause the cells to be under stress and weaken the cell membrane, resulting in the scFv proteins produced to leak from the cells before cleavage of the pelB leader sequence. The pelB leader sequence is approximately 2000 Da and based on the molecular weights of the bands observed on the SDS-PAGE gels, could account for the difference in the two bands if the proteins are folded correctly. To determine if the pelB leader sequence was present, analysis could be carried out by mass spectrometry to sequence the proteins. We are also interested in studying the interactions between the different subclone point mutations and the di-, tri- and tetrasaccharides, to determine which mutations are necessary for binding to smaller saccharides, as well as to quantify the contributions from residues associated with maturation of the IgM (B6.1) to IgG (C3.1). In



particular it would be interesting to determine how the N56D and T60A mutations would change the binding affinities as these are the only residues present in a complementary determining region. The other four amino acid mutations Q5K, S79T, V81I and A90V are all present in the framework regions 1 and 3, and normally these are considered scaffold regions which display the CDRs for antigen binding but have no role in antigen binding.

The carbohydrate-processing enzyme  $\alpha$ -L-Fucosidase from *T. maritima* (Sulzenbacher et al. 2004) is the closest bacterial relative to mammalian  $\alpha$ -L-Fucosidase. The binding specificity of this enzyme is not known and we are interested in studying this. It is known that  $\alpha$ -L-Fucosidase enzymes cleave terminal fucose residues, but some have differing specificities for linkages such as a preference for  $\alpha$ 1-3/ $\alpha$ 1-4 linked fucose over  $\alpha$ 1-2/ $\alpha$ 1-6 linked fucose (Ashida et al. 2009). We were interested in studying the linkage specificity of the  $\alpha$ -L-Fucosidase, as its potential to differentiate between linkages could make it an interesting target for the development of diagnostic reagents. There are a number of fucose containing glycans that have been shown to be overexpressed in different cancers such as Le<sup>a</sup>, Le<sup>b</sup>, Le<sup>x</sup>, Le<sup>y</sup>, sLe<sup>a</sup> and sLe<sup>x</sup> and also some bacteria use the presence of Lewis antigens on normal tissue as a method to adhere and colonise the gut in humans. The synthesis pathway for the Lewis antigens and the sialylated Lewis a and x are well understood (Cazet et al. 2010), but the degradation pathway of these sialylated glycans are not known. The degradation can proceed in two possible ways, either defucosylation followed by de-sialylation, or vice versa. Determining the specificity of the  $\alpha$ -L-Fucosidase would help provide an indication into which order these glycans are degraded.

We engineered  $\alpha$ -L-Fucosidase based on the  $\alpha$ -L-Fucosidase from *Thermotoga maritima*. Site-directed mutagenesis was used to generate two inactive mutants based on a previous report identifying the aspartic acid residue 224 as being the catalytic nucleophile (Tarling et al. 2003). At this time it was also known that mutating this residue to an alanine resulted in a 1000-fold decrease in activity in comparison to the wild type enzyme. The  $\alpha$ -L-Fucosidase mutants were then expressed in *E. coli* where they were found to form inclusion bodies. To overcome this, the D224N  $\alpha$ -L-Fucosidase mutant was expressed as a fusion protein with MBP to enable soluble expression.

After purification, the MBP was cleaved and subsequently separated from the D224N-5His  $\alpha$ -L-Fucosidase via IMAC.

Initially we screened both the D224N-5His and D224N-5His-MBP fusion proteins against the CFG glycan array, but this failed to detect any appreciable binding to any glycans. There is a number of possible reasons for this including inactivation of the protein, clash of the protein with the surface of the array, low affinity of the  $\alpha$ -L-Fucosidase for any glycan present on the array, or due to lack of optimisation of conditions for screening the protein. Subsequently, ELISA assays were used to determine specificity for the  $\alpha$ -L-Fucosidase. We have also shown that fucosidase is specific for L-fucose in comparison to a number of other monosaccharides including L-rhamnose, D-mannose, D-galactose and N-acetylglucosamine where no binding was detected via ELISA. Binding preference to Lewis x and sialyl Lewis x were also examined via ELISA, where it was shown that there was no binding to either. Although there was no binding to Lewis x, this is thought to be due to the short length of the linker (C3-linker) in comparison to the C-14 linker that was used to conjugate the monosaccharides and sialyl Lewis x to BSA. It was not possible to determine if the fucosidase would bind to Lewis x via ELISA as we could not source Lewis x conjugated to BSA with a C14 linker. Inhibition ELISA assays were carried out with L-fucose, Lewis x and sialyl Lewis x, with the fucosidase having the strongest affinity for fucose and weakest affinity for sialyl Lewis x. SPR experiments were performed to determine whether D224N-5His bound to Le<sup>x</sup> and sLe<sup>x</sup>, and to quantify any measurable dissociation constants for these ligands. For Le<sup>x</sup>, a  $K_D$  of  $19.1 \pm 7 \mu\text{M}$  was determined, which shows that D224N-5His has a ten-fold stronger affinity for Le<sup>x</sup> over reported values for other fucose-binding proteins, such as the lectins *Lotus tetragonolobus* A (225  $\mu\text{M}$ ) or *Aleuria aurantia* agglutinin, (220  $\mu\text{M}$ )(Haselhorst et al. 2001). There was no measurable binding detected for sLe<sup>x</sup>, suggesting that sialylation blocks ligand binding, and that this fucosidase must therefore act prior to sialylation.

Recently the GH29  $\alpha$ -L-Fucosidases have been classified into two subfamilies, based on phylogenetic analysis. Members of the GH29-A family, which include both the human and bacterial (*T. maritima*)  $\alpha$ -L-Fucosidases, have more relaxed substrate specificity in comparison to  $\alpha$ -L-Fucosidases in the GH29-B family, including those

from *Streptomyces* species and *Bifidobacterium bifidum* which act on either  $\alpha$ 1-3 or  $\alpha$ 1-4 linked fucose (Sakurama et al. 2012; Shaikh et al. 2013). So far, we have determined that D224N-5His, will bind to Le<sup>x</sup> ( $\alpha$ 1-3 linked fucose) but its broader substrate specificity is not fully known.

The specificity of D224N-5His for Le<sup>x</sup> over sLe<sup>x</sup> suggests that this inactive mutant of the fucosidase might be useful as a reagent for detecting the presence of Le<sup>x</sup> on cell surfaces. Lewis antigens are present on normal cells, but the over expression of them can be markers of diseases such as cancer. Le Pendu *et al.* have reviewed the overexpression of the Lewis antigens; Le<sup>a</sup>, Le<sup>b</sup>, Le<sup>x</sup> and Le<sup>y</sup> in a number of different cancers including lung, thyroid, bladder and ovarian (Le Pendu et al. 2001). In addition, gastric colonisation by *Helicobacter pylori* can in some cases lead to gastritis, ulcers and gastric cancer (Kusters et al. 2006). For adhesion to the human gastric epithelium cells, *H. pylori* binds to Le<sup>b</sup> through the blood group antigen-binding adhesin (BabA). The Lewis antigens Le<sup>a</sup>, Le<sup>b</sup>, Le<sup>x</sup> and Le<sup>y</sup> could therefore also be interesting targets for the development of a high affinity anti-adhesin reagent, for example based on D224N-5His.

As the full specificity of the  $\alpha$ -L-Fucosidase is still not known we would be interested in studying the interactions between  $\alpha$ -L-Fucosidase and the Lewis antigens Le<sup>a</sup>, Le<sup>b</sup>, Le<sup>x</sup> and Le<sup>y</sup>. The linkages that would be tested are Le<sup>a</sup> ( $\alpha$ 1-4), Le<sup>b</sup> ( $\alpha$ 1-2/ $\alpha$ 1-4), Le<sup>x</sup> ( $\alpha$ 1-3) and Le<sup>y</sup> ( $\alpha$ 1-2/ $\alpha$ 1-4). This could be tested using inhibition ELISA assays to determine if there was inhibition of  $\alpha$ -L-fucosidase binding to L-fucose and also via SPR. Screening of the  $\alpha$ -L-fucosidase against a glycans array is another method that could be used to determine specificity. This would allow for the  $\alpha$ -L-fucosidase binding specificity to be examined against a much larger number of glycan structures. After the specificity of the fucosidase is known, it could potentially be engineered via site-saturation mutagenesis and phage display to generate a library of proteins, which could be screened for higher affinity and specificity for a target of interest.

## References

- Ashida, H. et al., 2009. Two distinct alpha-L-fucosidases from *Bifidobacterium bifidum* are essential for the utilization of fucosylated milk oligosaccharides and glycoconjugates. *Glycobiology*, 19(9), pp.1010–1017. Available at: <http://ovidsp.ovid.com/ovidweb.cgi?T=JS&NEWS=N&PAGE=fulltext&AN=0002513-200909000-00012&D=ovftj>.
- Cazet, A. et al., 2010. Tumour-associated carbohydrate antigens in breast cancer. *Breast cancer research*: BCR, 12(3), p.204. Available at: <http://breast-cancer-research.com/content/12/3/204> [Accessed October 20, 2013].
- Haselhorst, T., Weimar, T. & Peters, T., 2001. Molecular recognition of sialyl Lewis(x) and related saccharides by two lectins. *Journal of the American Chemical Society*, 123(43), pp.10705–10714. Available at: [http://www.ncbi.nlm.nih.gov/entrez/query.fcgi?cmd=Retrieve&db=PubMed&dopt=Citation&list\\_uids=11674003](http://www.ncbi.nlm.nih.gov/entrez/query.fcgi?cmd=Retrieve&db=PubMed&dopt=Citation&list_uids=11674003).
- Kusters, J.G., van Vliet, A.H.M. & Kuipers, E.J., 2006. Pathogenesis of *Helicobacter pylori* Infection. *Clinical Microbiology Reviews*, 19 (3), pp.449–490. Available at: <http://cmr.asm.org/content/19/3/449.abstract>.
- Nitz, M. et al., 2002. The unique solution structure and immunochemistry of the *Candida albicans* beta -1,2-mannopyranan cell wall antigens. *The Journal of Biological Chemistry*, 277(5), pp.3440–3446. Available at: <http://www.ncbi.nlm.nih.gov/pubmed/11700318>.
- Le Pendu, J. et al., 2001. ABH and Lewis histo-blood group antigens in cancer. *APMIS*, 109(1), pp.9–26. Available at: <http://dx.doi.org/10.1111/j.1600-0463.2001.tb00011.x>.
- Sakurama, H. et al., 2012. Differences in the Substrate Specificities and Active-Site Structures of Two  $\alpha$ -L-Fucosidases (Glycoside Hydrolase Family 29) from *Bacteroides thetaiotaomicron*. *Bioscience, Biotechnology, and Biochemistry*, 76(5), pp.1022–1024.
- Shaikh, F.A. et al., 2013. Identifying the Catalytic Acid/Base in GH29  $\alpha$ -L-Fucosidase Subfamilies. *Biochemistry*, 52(34), pp.5857–5864. Available at: <http://dx.doi.org/10.1021/bi400183q>.
- Sulzenbacher, G. et al., 2004. Crystal structure of *Thermotoga maritima* alpha-L-fucosidase. Insights into the catalytic mechanism and the molecular basis for fucosidosis. *The Journal of Biological Chemistry*, 279(13), pp.13119–13128.
- Tarling, C.A. et al., 2003. Identification of the catalytic nucleophile of the family 29 alpha-L-fucosidase from *Thermotoga maritima* through trapping of a covalent glycosyl-enzyme intermediate and mutagenesis. *The Journal of Biological Chemistry*, 278(48), pp.47394–47399. Available at: <http://www.jbc.org/cgi/content/abstract/278/48/47394>.

Wilson, I.A. & Stanfield, R.L., 1994. Antibody-antigen interactions: new structures and new conformational changes. *Current Opinion in Structural Biology*, 4(6), pp.857–867. Available at:  
<http://www.sciencedirect.com/science/article/pii/0959440X94902674>  
[Accessed February 5, 2014].

**Appendix I: C3.1 scFv Nucleotide and protein sequence including restriction sites**

Name of the gene **C3.1\_scFv**  
 optimized for **Escherichia coli**

Map



1 GAGCGGAAGGCCCATGAGGCCAGTTAATTAAGAGGTACCATGGCCCAGGTGCAGCTGCAG  
 -----+-----+-----+-----+-----+-----+-----+  
 CTCGCCTTCCGGGTACTCCGGTCAATTAATTCTCCATGGTACCGGGTCCACGTCGACGTC  
 M\_A\_Q\_V\_Q\_L\_Q\_

61 GAATCTGGCGGTGGTCTGGTTCAGCCGGGTGGCAGCATGAAACTGAGCTGCGTGGCGAGC  
 -----+-----+-----+-----+-----+-----+-----+  
 CTTAGACCGCCACCAGACCAAGTCGGCCCACCGTCGTACTIONTTGACTCGACGCACCGCTCG  
 E\_S\_G\_G\_G\_L\_V\_Q\_P\_G\_G\_S\_M\_K\_L\_S\_C\_V\_A\_S\_

121 GAATTTACCTTTAACAACACTATTGGATGAACTGGGTGCGTCAGAGCCCCGAAAAGGCCTG  
 -----+-----+-----+-----+-----+-----+-----+  
 CTTAAATGGAATTTGTTGATAACCTACTTGACCCACGCAGTCTCGGGCCTTTTTCCGGAC  
 E\_F\_T\_F\_N\_N\_Y\_W\_M\_N\_W\_V\_R\_Q\_S\_P\_E\_K\_G\_L\_

181 GAATGGGTGGCGGAAATTCGTCTGAAAAGCAACAACACTATGCGACCCATTATGCGGAAAGC  
 -----+-----+-----+-----+-----+-----+-----+  
 CTTACCCACCGCCTTTAAGCAGACTTTTCGTTGTTGATACGCTGGGTAATACGCCTTTTCG  
 E\_W\_V\_A\_E\_I\_R\_L\_K\_S\_N\_N\_Y\_A\_T\_H\_Y\_A\_E\_S\_

241 GTGAAAGGCCGTTTTACCATTAGCCGTGATGATAGCAAAGCAGCGTGTATCTGCAGATG  
 -----+-----+-----+-----+-----+-----+-----+  
 CACTTTCCGGCAAAATGGTAATCGGCACACTACTATCGTTTTTCGTCGCACATAGACGTCTAC  
 V\_K\_G\_R\_F\_T\_I\_S\_R\_D\_D\_S\_K\_S\_S\_V\_Y\_L\_Q\_M\_

301 AACAACCTGCGTGCGGAAGATACCGCATTATTATTATGCACCAGCAACGTGGCGATGGAT  
 -----+-----+-----+-----+-----+-----+-----+  
 TTGTTGGACGCACGCCTTCTATGGCCGTAATAATAACGTGGTTCGTTGCACCGCTACCTA  
 N\_N\_L\_R\_A\_E\_D\_T\_G\_I\_Y\_Y\_C\_T\_S\_N\_V\_A\_M\_D\_

361 TATTGGGGCCAGGGCACCACCGTTACCGTGAGCAGCGGTGGCGGAGGGAGCGGTGGTGGC  
 -----+-----+-----+-----+-----+-----+-----+  
 ATAACCCCGGTCCCGTGGTGGCAATGGCACTCGTCGCCACCGCCTCCCTCGCCACCACCG  
 Y\_W\_G\_Q\_G\_T\_T\_V\_T\_V\_S\_S\_G\_G\_G\_G\_S\_G\_G\_G\_

GGCTCTGGCGGCGGTGGCAGCGATATTGAACTGACCCAGTCTCCGGCGATTATGAGCGCG  
 421 -----+-----+-----+-----+-----+-----+-----+  
 CCGAGACCGCCGCCACCGTCGCTATAACTTGACTGGGTGAGAGGCCGCTAATACTCGCGC  
 G \_ S \_ G \_ G \_ G \_ G \_ S \_ D \_ I \_ E \_ L \_ T \_ Q \_ S \_ P \_ A \_ I \_ M \_ S \_ A \_

BspMI  
 SmaI PstI

AGCCCCGGTGAAAAAGTGACCCTGACCTGCAGCGCGAGCAGCAGCGTGACCTATATGTTT  
 481 -----+-----+-----+-----+-----+-----+-----+  
 TCGGGCCCACTTTTTCACTGGGACTGGACGTCGCGCTCGTTCGTCGCACTGGATATACAAA  
 S \_ P \_ G \_ E \_ K \_ V \_ T \_ L \_ T \_ C \_ S \_ A \_ S \_ S \_ S \_ V \_ T \_ Y \_ M \_ F \_  
 TGGTATCAGCAGAAACCGGGCAGCAGCCCGCTCTGCTGATTTATGATACCAGCAACCTG  
 541 -----+-----+-----+-----+-----+-----+-----+  
 ACCATAGTCGTCTTTGGCCCGTCGTCGGGCGCAGACGACTAAATACTATGGTCGTTGGAC  
 W \_ Y \_ Q \_ Q \_ K \_ P \_ G \_ S \_ S \_ P \_ R \_ L \_ L \_ I \_ Y \_ D \_ T \_ S \_ N \_ L \_

GCCAGCGGTGTGCCGGTGCGTTTTAGCGGCAGCGGTAGCGGCACCAGCTATAGCCTGACC  
 601 -----+-----+-----+-----+-----+-----+-----+  
 CGGTGCCACACGGCCACGCAAATCGCCGTCGCCATCGCCGTGGTCGATATCGGACTGG  
 A \_ S \_ G \_ V \_ P \_ V \_ R \_ F \_ S \_ G \_ S \_ G \_ S \_ G \_ T \_ S \_ Y \_ S \_ L \_ T \_

ATTAGCCGCATGGAAGCGGAAGATGCGGCGACCTATTATTGCCAGCAGTGGAGCAATAGC  
 661 -----+-----+-----+-----+-----+-----+-----+  
 TAATCGGCGTACCTTCGCCTTCTACGCCGCTGGATAATAACGGTCGTCACCTCGTTATCG  
 I \_ S \_ R \_ M \_ E \_ A \_ E \_ D \_ A \_ A \_ T \_ Y \_ Y \_ C \_ Q \_ Q \_ W \_ S \_ N \_ S \_

NotI  
 EagI  
 EagI SacI

CCGCGCACCTTTGGCGGTGGCACCAAACCTGAAATTAAGGCTAATAAGCGCCGCGAGC  
 721 -----+-----+-----+-----+-----+-----+-----+  
 GGCGCGTGGAACCGCCACCGTGGTTTTGACCTTTAATTTCCGATTATTGCGCGGCGCTCG  
 P \_ R \_ T \_ F \_ G \_ G \_ G \_ T \_ K \_ L \_ E \_ I \_ K \_ G \_ \* \_ \* \_

AscI  
 BssHII StuI

TCATGGCGCGCCTAGGCCTTGACGGCCTTCCGCCA  
 781 -----+-----+-----+-----+-----+-----+-----+  
 AGTACCGCGCGGATCCGGAACCTGCCGGAAGGCGGT

## Appendix II: $\alpha$ -L-Fucosidase Nucleotide and protein sequence including restriction sites

Name of the gene  **$\alpha$ -L-Fuc** Map  
 optimized for Escherichia coli



NcoI

PacI      KpnI

1 TGAAGGAAGGCCCATGAGGCCAGTTAATTAAGAGGTACCATGGCAAGCATGAAACCGCG  
 -----+-----+-----+-----+-----+-----+-----+  
 ACTTTCCTTCCGGGTACTCCGGTCAATTAATTCTCCATGGTACCGTTCGTA C T T T G G C G C  
M \_ A \_ S \_ M \_ K \_ P \_ R \_

61 TTATAAACCGGATTGGGAAAGCCTGCGTGAACATACCGTTCCGAAATGGTTTGATAAAGC  
 -----+-----+-----+-----+-----+-----+-----+  
 AATATTTGGCCTAACCCCTTTCGGACGCACTTGTATGGCAAGGCTTTACCAA C T A T T T T C G  
 Y \_ K \_ P \_ D \_ W \_ E \_ S \_ L \_ R \_ E \_ H \_ T \_ V \_ P \_ K \_ W \_ F \_ D \_ K \_ A \_

AgeI

121 CAAATTCGGCATT T T T T A T T C A T T G G G G C A T T T A T A G C G T T C C G G G T T G G G C A A C C C C G A C  
 -----+-----+-----+-----+-----+-----+-----+  
 GTTTAAGCCGTAAAAATAAGTAACCCCGTAAATATCGCAAGGCCCAACCCGTTGGGGCTG  
 K \_ F \_ G \_ I \_ F \_ I \_ H \_ W \_ G \_ I \_ Y \_ S \_ V \_ P \_ G \_ W \_ A \_ T \_ P \_ T \_

181 CGGTGAAC T G G G T A A A G T T C C G A T G G A T G C A T G G T T T T T T C A G A A T C C G T A T G C C G A A T G  
 -----+-----+-----+-----+-----+-----+-----+  
 GCCACTTGACCCATTTCAAGGCTACCTACGTACCAAAAAAGTCTTAGGCATACGGCTTAC  
 G \_ E \_ L \_ G \_ K \_ V \_ P \_ M \_ D \_ A \_ W \_ F \_ F \_ Q \_ N \_ P \_ Y \_ A \_ E \_ W \_

241 GTATGAAAATAGCCTGCGCATTAAAGAAAGCCCGACCTGGGAATATCATGTTAAAACCTA  
 -----+-----+-----+-----+-----+-----+-----+  
 CATACTTTTATCGGACGCGTAATTTCTTTTCGGGCTGGACCCTTATAGTACAATTTTGGAT  
 Y \_ E \_ N \_ S \_ L \_ R \_ I \_ K \_ E \_ S \_ P \_ T \_ W \_ E \_ Y \_ H \_ V \_ K \_ T \_ Y \_

BamHI

301 TGGCGAAAATTTTGAATATGAAAATTTGCCGACCTGTTTACCGCAGAAAATGGGATCC  
 -----+-----+-----+-----+-----+-----+-----+  
 ACCGCTTTTAAAACCTTATACTTTTAAACGGCTGGACAAATGGCGTCTTTTACCCTAGG  
 \_ G \_ E \_ N \_ F \_ E \_ Y \_ E \_ K \_ F \_ A \_ D \_ L \_ F \_ T \_ A \_ E \_ K \_ W \_ D \_ P \_

361 GCAAGAATGGGCAGACCTGTTTAAAAAAGCCGGTGCCAAATATGTTATTCCGACCACCAA  
 -----+-----+-----+-----+-----+-----+-----+  
 CGTTCTTACCCGTCTGGACAAATTTTTCGGCCACGGTTTATACAATAAGGCTGGTGGTT  
 \_ Q \_ E \_ W \_ A \_ D \_ L \_ F \_ K \_ K \_ A \_ G \_ A \_ K \_ Y \_ V \_ I \_ P \_ T \_ T \_ K \_

421 ACATCATGATGGTTTTTGTCTGTGGGGCACCAAATACACCGATTTTAATAGCGTTAAACG  
 -----+-----+-----+-----+-----+-----+-----+  
 TGTAGTACTACCAAAACAGACACCCCGTGGTTTATGTGGCTAAAATTATCGCAATTTGC  
 \_ H \_ H \_ D \_ G \_ F \_ C \_ L \_ W \_ G \_ T \_ K \_ Y \_ T \_ D \_ F \_ N \_ S \_ V \_ K \_ R \_



## BspMI

CGGTCCGAAACGTGATCTGGTTGGTGTGATCTGGCAAAGCAGTTCGTGAAGCAGGTCTGCG  
 481 -----+-----+-----+-----+-----+-----+-----+  
 GCCAGGCTTTGCACTAGACCAACCACTAGACCGTTTTTCGTCAAGCACTTCGTCCAGACGC  
 \_G\_P\_K\_R\_D\_L\_V\_G\_D\_L\_A\_K\_A\_V\_R\_E\_A\_G\_L\_R\_

TTTTGGTGTATTATTATAGCGGTGGTCTGGATTGGCGTTTTACCACCGAACCGATTTCGTTA  
 541 -----+-----+-----+-----+-----+-----+-----+  
 AAAACCACAAATAATATCGCCACCAGACCTAACCGCAAATGGTGGCTTGGCTAAGCAAT  
 \_F\_G\_V\_Y\_Y\_S\_G\_G\_L\_D\_W\_R\_F\_T\_T\_E\_P\_I\_R\_Y\_

## BglII

TCCGGAAGATCTGAGTTATATTCGTCCGAATACCTATGAATATGCCGATTATGCCTATAA  
 601 -----+-----+-----+-----+-----+-----+-----+  
 AGGCCTTCTAGACTCAATATAAGCAGGCTTATGGATACTTATACGGCTAATACGGATATT  
 \_P\_E\_D\_L\_S\_Y\_I\_R\_P\_N\_T\_Y\_E\_Y\_A\_D\_Y\_A\_Y\_K\_

ACAGGTTATGGAACGGTGGATCTGTATCTGCCGGATGTTCTGTGGAATGATATGGGTTG  
 661 -----+-----+-----+-----+-----+-----+-----+  
 TGTCCAATACCTTGACCACCTAGACATAGACGGCCTACAAGACACCTTACTATACCCAAC  
 \_Q\_V\_M\_E\_L\_V\_D\_L\_Y\_L\_P\_D\_V\_L\_W\_N\_D\_M\_G\_W\_

## BglII

GCCTGAAAAAGGTAAAGAAGATCTGAAATACCTGTTTGCCTATTATTACAATAAACATCC  
 721 -----+-----+-----+-----+-----+-----+-----+  
 CGGACTTTTTCCATTTCTTCTAGACTTTATGGACAAACGGATAATAATGTTATTTGTAGG  
 \_P\_E\_K\_G\_K\_E\_D\_L\_K\_Y\_L\_F\_A\_Y\_Y\_Y\_N\_K\_H\_P\_

GGAAGGCAGCGTGAATGATCGTTGGGGTGTTCGCGATTGGGATTTCAAACCGCAGAATA  
 781 -----+-----+-----+-----+-----+-----+-----+  
 CCTTCCGTCGCACTTACTAGCAACCCACAAGGCGTAACCCTAAAGTTTTGGCGTCTTAT  
 \_E\_G\_S\_V\_N\_D\_R\_W\_G\_V\_P\_H\_W\_D\_F\_K\_T\_A\_E\_Y\_

TCATGTGAATTATCCGGGTGATCTGCCTGGTTATAAATGGGAATTTACCCGTGGTATTGG  
 841 -----+-----+-----+-----+-----+-----+-----+  
 AGTACACTTAATAGGCCCACTAGACGGACCAATATTTACCCTTAAATGGGCACCATAACC  
 \_H\_V\_N\_Y\_P\_G\_D\_L\_P\_G\_Y\_K\_W\_E\_F\_T\_R\_G\_I\_G\_

## NdeI

## PvuII

TCTGAGCTTTGGTTATAATCGTAATGAAGGTCCGGAACATATGCTGAGCGTTGAACAGCT  
 901 -----+-----+-----+-----+-----+-----+-----+  
 AGACTCGAAACCAATATTAGCATTACTTCCAGGCCTTGTATACGACTCGCAACTTGTGCA  
 \_L\_S\_F\_G\_Y\_N\_R\_N\_E\_G\_P\_E\_H\_M\_L\_S\_V\_E\_Q\_L\_

GGTTTATACCCTGGTTGATGTTGTTAGCAAAGGTGGTAATCTGCTGCTGAATGTTGGTCC  
 961 -----+-----+-----+-----+-----+-----+-----+  
 CCAAATATGGGACCAACTACAACAATCGTTTTCCACCATTAGACGACGACTTACAACCAGG  
 \_V\_Y\_T\_L\_V\_D\_V\_V\_S\_K\_G\_G\_N\_L\_L\_L\_N\_V\_G\_P\_

## PstI

GAAAGGTGATGGCACCATTCCGGATCTGCAGAAAGAACGTCTGCTGGGTCTGGGTGAATG  
 1021-----+-----+-----+-----+-----+-----+  
 CTTTCCACTACCGTGGTAAGGCCTAGACGTCTTTCTTGCAGACGACCCAGACCCACTTAC  
  K  G  D  G  T  I  P  D  L  Q  K  E  R  L  L  G  L  G  E  W  

## PflMI

GCTGCGTAAATATGGTGATGCAATTTATGGCACCAGCGTTTGGGAACGTTGTTGTGCAAA  
 1081-----+-----+-----+-----+-----+-----+  
 CGACGCATTTTATACCACTACGTAAATACCGTGGTCGCAAACCCTTGCAACAACACGTTT  
  L  R  K  Y  G  D  A  I  Y  G  T  S  V  W  E  R  C  C  A  K  

AACCGAAGATGGCACCAGAAATTCGTTTTACCCGTAAATGCAATCGCATTTTTGTGATTTT  
 1141-----+-----+-----+-----+-----+-----+  
 TTGGCTTCTACCGTGGCTTTAAGCAAAATGGGCATTTACGTTAGCGTAAAAACACTAAAA  
  T  E  D  G  T  E  I  R  F  T  R  K  C  N  R  I  F  V  I  F  

## BglII

TCTGGGTATTCCGACGGGTGAAAAAATTGTTATTGAAGATCTGAATCTGAGCGCAGGCAC  
 1201-----+-----+-----+-----+-----+-----+  
 AGACCCATAAGGCTGCCCACTTTTTTAACAATAACTTCTAGACTTAGACTCGCGTCCGCTG  
  L  G  I  P  T  G  E  K  I  V  I  E  D  L  N  L  S  A  G  T  

## AgeI

CGTTCGTCAATTTCTGACCGTGAACGTCTGAGCTTTAAAAATGTGGGCAAAAATCTGGA  
 1261-----+-----+-----+-----+-----+-----+  
 GCAAGCAGTAAAAGACTGGCCACTTGCAGACTCGAAATTTTTACACCCGTTTTTAGACCT  
  V  R  H  F  L  T  G  E  R  L  S  F  K  N  V  G  K  N  L  E  

AATTACCGTGCCGAAAAAATGCTGGAAACCGATAGCATTACCCTGGTTCTGGAAGCAGT  
 1321-----+-----+-----+-----+-----+-----+  
 TTAATGGCACGGCTTTTTTGCAGACCTTTGGCTATCGTAATGGGACCAAGACCTTCGTCA  
  I  T  V  P  K  K  L  L  E  T  D  S  I  T  L  V  L  E  A  V  

## NcoI

## BssHII StuI

## PacI SacI AscI AvrII

TGAAGAAGCGGCCGCGAGCTCATGGCGCGCCTAGGCCTTGACGGCCTTCCTTC  
 1381-----+-----+-----+-----+-----+-----+  
 ACTTCTTCGCCGCGCTCGAGTACCGCGCGGATCCGGAACCTGCCGGAAGGAAG  
  E  E