



## Real-time monitoring framework to investigate the environmental and structural performance of buildings

Title	Real-time monitoring framework to investigate the environmental and structural performance of buildings
Author(s)	Hajdukiewicz, Magdalena;Byrne, David;Keane, Marcus M.;Goggins, Jamie
Publication Date	2014-12-20
Publisher	Elsevier ScienceDirect
Repository DOI	<a href="https://doi.org/10.1016/j.buildenv.2014.12.012">10.1016/j.buildenv.2014.12.012</a>

**Real-time monitoring framework to investigate the environmental and structural performance of buildings.**

Dr. Magdalena Hajdukiewicz <sup>a,b,c</sup>

Mr. David Byrne <sup>b,c</sup>

Dr. Marcus M. Keane <sup>a,b,c</sup>

Dr. Jamie Goggins <sup>b,c</sup>

<sup>a</sup> *Informatics Research Unit for Sustainable Engineering (IRUSE) Galway, Ireland*

<sup>b</sup> *College of Engineering and Informatics, National University of Ireland Galway, Galway, Ireland*

<sup>c</sup> *Ryan Institute, National University of Ireland Galway, Galway, Ireland*

Corresponding author: *Jamie Goggins*

*Department of Civil Engineering, National University of Ireland Galway, Galway, Ireland*

*E-mail: [jamie.goggins@nuigalway.ie](mailto:jamie.goggins@nuigalway.ie)*

*Phone: +353 (0) 91 49 26 09*

**Please reference as:**

**Hajdukiewicz, M., Byrne, D., Keane, M.M., & Goggins, J., 2015. 'Real-time monitoring framework to investigate the environmental and structural building performance'. *Building and Environment*, 86, pp. 1-16. <http://dx.doi.org/10.1016/j.buildenv.2014.12.012>**

## **Abstract**

Energy provides safety, comfort and mobility to people, and is essential for industrial, commercial and societal growth. However, generation and consumption of energy give rise of greenhouse gases and various air pollutants, which have a negative impact on the natural environment and global climate. The building sector is responsible for about 40% of the energy consumption and related CO<sub>2</sub> emissions worldwide. In order to reduce the environmental impact of buildings, energy efficient measures must be taken into account when designing, operating and retrofitting buildings. It is imperative that holistic consideration is given to the structural, environmental and energy aspects in buildings through their life. In order to maintain safe, healthy and comfortable sustainable buildings, assurance of the structural and environmental building performance must be given not only at the design, but also commissioning and operation stages of its life cycle.

This paper presents the motivation, objectives and method description of the measurement framework developed at the National University of Ireland Galway in order to continuously monitor the structural and environmental performance of operating buildings. The proposed real-time monitoring provides rich information about the building performance, offering opportunities for better control strategies for operating buildings. This may lead to safer, healthier, more comfortable and productive indoor environments, at the same time ensuring the reduced/optimised energy consumption in buildings.

## **Keywords**

Buildings; monitoring; environmental performance; structural performance;

## **1. Introduction**

Energy provides safety, comfort and mobility to people and is essential for industrial, commercial and societal growth. However, generation and consumption of energy give rise of greenhouse gases and various air pollutants, and issues such as waste generation and oil spills are associated with various fuels [1]. All of those factors have a negative impact on the natural environment and global climate. The building sector is responsible for about 40% of the energy consumption and over 30% CO<sub>2</sub> emissions worldwide [2]–[4]. Among building services, the contribution of the heating,

**Please reference as:**

**Hajdukiewicz, M., Byrne, D., Keane, M.M., & Goggins, J., 2015. 'Real-time monitoring framework to investigate the environmental and structural building performance'. *Building and Environment*, 86, pp. 1-16. <http://dx.doi.org/10.1016/j.buildenv.2014.12.012>**

ventilation and air conditioning (HVAC) systems in energy use is particularly significant, reaching up to half of the energy consumed by buildings [5].

Considering the impacts of human induced climate change and exploitation of natural resources, the building sector must consider aggressive energy efficiency measures. This can be achieved by reducing energy and greenhouse emissions through promoting 'nearly-zero energy buildings'.

On May 19<sup>th</sup>, 2010, the European Union (EU) adopted the Directive 2010/31/EU [6], which aimed to reduce energy consumed by buildings. Member States are requested to adopt a methodology for calculating the energy performance of buildings (energy performance certification). The objective of the Directive 2010/31/EU is to ensure all new buildings are almost zero-energy consumption buildings from the end of 2020.

In order to meet the requirements posed by the EU and, thus, reduce the environmental impact of buildings, energy efficient measures must be taken into account when designing, operating and retrofitting buildings. Reducing energy consumption and CO<sub>2</sub> emissions through energy efficient and smart technologies in operating buildings (e.g. in terms of heating, ventilation and air conditioning) would significantly decrease primary energy consumption by buildings.

However, reducing the energy consumption is not the only critical aspect of building operation. At the same time, it is very important to maintain safe, healthy and comfortable indoor conditions for building occupants, since people spend up to 90% of their lives indoors [7]. Knowledge about the heat, air and moisture transport through the building system components is vital in evaluating the building's structural and environmental performance.

Monitoring of energy performance is an important aspect of assessing sustainability of buildings [8]. Innovations in sensor technology (including wireless sensor networks [9]), data acquisition and computer technology allow for improved monitoring of internal conditions and energy consumption in buildings [10].

Many modern buildings are equipped with various monitoring and control systems, i.e. building management systems (BMSs). The majority of BMSs monitor environmental conditions and energy consumption during the operation phase of the building life cycle. However, in order to achieve desired operation of the building, the commissioning process must be completed. A sensor overlay method was presented previously [11] that supported control commissioning and maintenance of an advanced naturally ventilated building (equipped with a BMS). A natural ventilation strategy was tested by measuring indoor temperatures and air quality (CO<sub>2</sub> and volatile organic compounds concentrations), and a complex fine-tuning process was performed in the first year of building's operation.

Furthermore, building monitoring frameworks have been developed in order to investigate the energy consumption (e.g. [12], [13]), or holistically examine building performance, including energy consumption, performance of the building

**Please reference as:**

**Hajdukiewicz, M., Byrne, D., Keane, M.M., & Goggins, J., 2015. 'Real-time monitoring framework to investigate the environmental and structural building performance'. *Building and Environment*, 86, pp. 1-16. <http://dx.doi.org/10.1016/j.buildenv.2014.12.012>**

envelope and indoor air quality [10]. In order to support the energy awareness in buildings, an integrated building performance monitoring system has been developed [14]. This system combined a traditional building management system with a prediction engine, knowledge repository and modern scientific approaches.

Structural monitoring implies spatial distribution of sensors embedded in the structure to measure its structural response to environmental loads. One of the main reasons for the structural monitoring is the control of health and detection of damage of a structure during its life span [15]. Various external conditions may cause deterioration in the health of a structure and, thus, should be monitored. For instance, it has been shown previously that the measurement of ambient temperature and relative humidity is essential in structural health monitoring [16], [17]. Moreover, seismic hazards can be reduced in buildings by monitoring of vibration and displacement of the building structure during earthquakes [18], [19]. It has been previously identified that the difficulties to test the capabilities of structural health monitoring systems are caused by the small density of instrumented full-scale buildings in most seismically active regions of the world [19]. Structural health monitoring have related not only to buildings, but also bridges ([20], [21], [22]), historical [23] and other civil structures [24]. Moreover, various sensor networks have been used previously for structural health monitoring, including conventional wire-based (e.g. [20], [25]) or wireless networks (e.g. [1],[26]). However, there is a dearth of studies that use real-time measurements of demonstrator buildings to monitor the interaction between the structure, internal and external environments with the aim of improving the holistic performance of buildings.

It is imperative that consideration is given to the structural, environmental and energy aspects in buildings through their life. In order to maintain safe, healthy, sustainable and comfortable buildings, the assurance of the structural and environmental building performance must be given not only at the design, but also commissioning and operation stages of its life cycle.

## **2. Methodology**

### **2.1. Overview**

This paper presents the real-time measurement framework developed at the National University of Ireland (NUI) Galway in order to monitor the structural and environmental performance of operating buildings (Figure 1). This framework has been tested on two demonstration buildings (i) the Engineering Building (EB) and (ii) the Institute for Lifecourse and Society (ILAS) building at NUI Galway. Those two educational buildings represent a broad range of indoor environments (including large capacity buildings, office spaces, open plan lecture theatres and laboratory spaces) and ventilation types (i.e. passive, hybrid and mechanical); and, thus, form a strong basis for the development of the monitoring framework. Moreover, both buildings are predominantly built in the precast and in situ concrete technology.

**Please reference as:**

**Hajdukiewicz, M., Byrne, D., Keane, M.M., & Goggins, J., 2015. 'Real-time monitoring framework to investigate the environmental and structural building performance'. *Building and Environment*, 86, pp. 1-16. <http://dx.doi.org/10.1016/j.buildenv.2014.12.012>**

Concrete is the primary construction material in most of the sustainable developments in Europe [27]. Its thermal capacity leads to thermal stability and thus offers considerable energy savings and good quality of indoor environment. According to the Irish Concrete Society and Irish Concrete Federation '*Exposed concrete acts as a thermal moderator preventing rapid thermal swings, greatly reducing the need to cool office buildings, which is typically the biggest running cost. Only 10% is related to the construction of the building. Designing with energy in mind can reduce in-use energy costs by up to 75% and greatly reduce carbon dioxide emissions*' [28]. Thus, properly designed, commissioned and operated buildings that incorporate concrete structural systems can benefit from their thermal properties leading to [29]:

- Reduction in heating fuel due to solar gains.
- Reduction in heating energy consumption by 2–15%.
- Reduction in the building energy cost.
- Stable indoor temperatures, without high fluctuations.
- Delay in peak indoor temperatures in commercial buildings (until the occupants have left).
- Reduction in peak indoor temperatures.
- Possibility of night-time ventilation to eliminate the need for day-time cooling.
- Reduction in the energy used for cooling by up to 50% (in combination with air-conditioning).

This paper describes the motivation, objectives and method description of the framework that continuously monitors building performance through its life cycle, with the focus on building components and the influence of their properties on indoor environments.

The proposed real-time monitoring provides (i) rich information about the building performance metrics; (ii) better control strategies for operating buildings; (iii) safer, healthier, more comfortable and productive indoor environments; and (iv) reduced/optimised energy consumption in buildings.

The combination of the real-time field measurements in operating buildings, in situ weather monitoring and complementary laboratory experiments provides essential data to support the development and calibration of structural/environmental numerical building models (computational fluid dynamics (CFD), whole building simulation and reduced order models) at the NUI Galway. This allows (i) identification of possible design/operation drawbacks; (ii) proposal of optimised, cost-effective and sustainable designs; and (iii) development of new environmentally friendly and energy efficient structural building systems.

Figure 1. Overview of the real-time monitoring framework.

**Please reference as:**

**Hajdukiewicz, M., Byrne, D., Keane, M.M., & Goggins, J., 2015. 'Real-time monitoring framework to investigate the environmental and structural building performance'. *Building and Environment*, 86, pp. 1-16. <http://dx.doi.org/10.1016/j.buildenv.2014.12.012>**

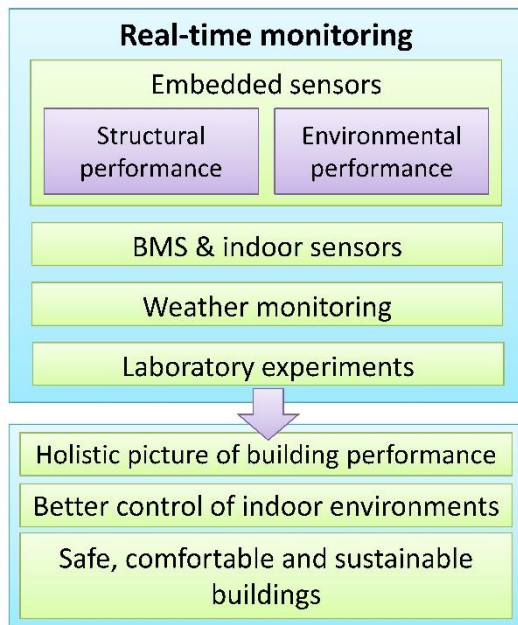

## 2.2. Structure-embedded sensors

This research utilised a number of sensors embedded in the buildings' structure, in order to monitor its structural and environmental performance. Those sensors include (Figure 2):

- Vibrating wire (VW) gauges (Gage Technique model TES/5.5/T [30]), which are capable measuring strain and temperature of concrete. The strains can be measured in a range greater than 3000 microstrain with a resolution better than 1 microstrain. The temperature can be measured in a range between -20 / +80 °C with an accuracy of +/- 1 °C.
- Electrical resistance (ER) strain gauges (Tokyo Sokki Kenkyujo model FLA-6-120-11-3LT [31]), which are capable of measuring strain of reinforcement with a resistance of 120 +/- 0.3 ohm or 119.5 +/-1% 0.5 ohm.
- IP68 rated thermistor sensors (ATC Semitec model IP68 [32]), which are capable of measuring concrete temperature in the range of between -60 / +150 °C with a 1% tolerance.

Both VW gauges and thermistors have proven to be robust and suitable for employment in the harsh environment of concrete and reinforcement steel. The ER gauges were tested in the first demonstrator building (Section 3). However, despite the application of the waterproof tape and sealant for the protection of the gauges, they were found to be too fragile for the severe processes of concrete hydration and reinforcement corrosion when monitoring structures on a long term basis. Initially, many of the installed ER gauges worked well, but over time many of them failed, which was likely due to corrosion of the gauges or lead wires. Thus, it was decided not to use the ER gauges in the second demonstrator (Section 4).

**Please reference as:**

**Hajdukiewicz, M., Byrne, D., Keane, M.M., & Goggins, J., 2015. 'Real-time monitoring framework to investigate the environmental and structural building performance'. *Building and Environment*, 86, pp. 1-16. <http://dx.doi.org/10.1016/j.buildenv.2014.12.012>**

Figure 2. Sensors embedded in the buildings' structure.

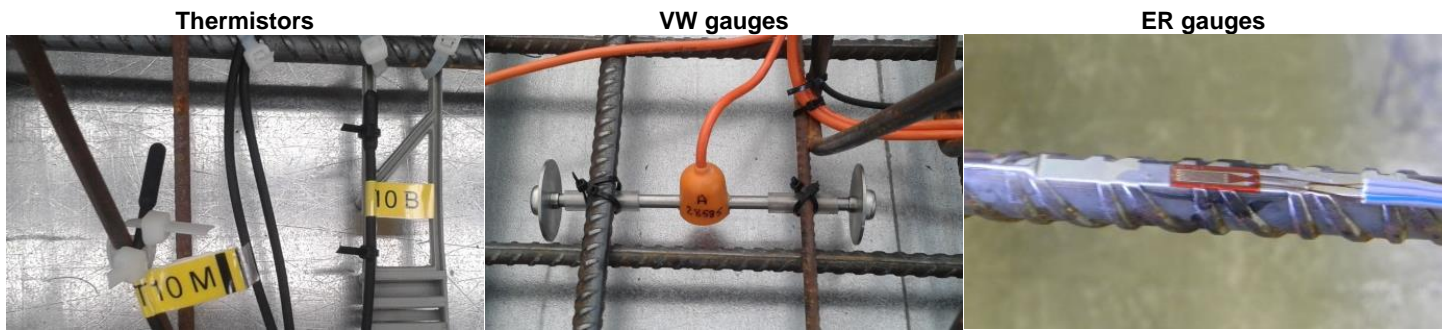

The data acquisition systems consisting of CR1000 data loggers and AM16/32B multiplexers obtained from Campbell Scientific [33] are employed in the demonstration buildings to collect and store live data measured by the sensors embedded in the buildings' structural elements. Those systems have been automatically logging data since the initial installation of the sensors. During the construction phase, data are stored on flash memory cards, which are manually downloaded weekly onto a laptop and backed-up on a server. After the building commissioning, data communication relies on the use of Campbell Scientific's NL115 Ethernet and Compact Flash Module [33] and allows for data collection over a local network.

The environmental and structural monitoring of the building structure commenced at the manufacturing stage of the precast elements, through the on site installation, and has continued during the building commissioning and operation underpinned by recognised national and international standards. The continuous monitoring and inspection of the data allowed strength gain of concrete to be evaluated against the design intent/standards/guidelines, as well as to determine any long term effects, such as creep. Moreover, the monitoring of heat transfer through the building envelope enabled the analysis of environmental performance of concrete structural elements and their influence on indoor environments. Understanding of the heat transfer and storage in the building structure allows, then, for the reduction in energy consumed by buildings, while optimising internal conditions for building occupants.

### 2.3. BMS and indoor sensors

The indoor air temperatures, CO<sub>2</sub> concentrations and energy/water consumption are monitored by the building management systems (BMSs). The BMSs control dampers and window openings depending on the indoor air temperatures and CO<sub>2</sub> concentrations and provide optimal indoor conditions for the building occupants. Moreover, the BMSs monitor the water and energy consumption in the buildings.

**Please reference as:**

**Hajdukiewicz, M., Byrne, D., Keane, M.M., & Goggins, J., 2015. 'Real-time monitoring framework to investigate the environmental and structural building performance'. *Building and Environment*, 86, pp. 1-16. <http://dx.doi.org/10.1016/j.buildenv.2014.12.012>**

Additional measurements to investigate indoor conditions in buildings can be performed by air/surface temperature sensors, air speed sensors and thermal cameras. Indoor air temperatures can be recorded by the Hobo U12 data loggers (Figure 3a) [34]. The Hobo U12 data loggers allow for the measurement of air temperatures between  $-20\text{ }^{\circ}\text{C}$  and  $70\text{ }^{\circ}\text{C}$ , with an accuracy of  $\pm 0.35\text{ }^{\circ}\text{C}$  in a range between  $0\text{ }^{\circ}\text{C}$  and  $50\text{ }^{\circ}\text{C}$ . The air speed sensors (Figure 3c) [34] allow for the measurement of air speeds between  $0.15\text{ m/s}$  and  $5\text{ m/s}$ , with an accuracy greater of 10% of reading or  $\pm 0.05\text{ m/s}$  or 1% full-scale. The surface temperatures can be measured by the temperature sensors TMC6-HE [34] (Figure 3b) with the accuracy of  $\pm 0.25\text{ }^{\circ}\text{C}$  in a range between  $0\text{ }^{\circ}\text{C}$  and  $50\text{ }^{\circ}\text{C}$ . The surface temperatures can also be measured using a thermal camera FLIR T335 [35] with the accuracy of  $\pm 2\text{ }^{\circ}\text{C}$  or 2% of the reading (Figure 3d). The measurements of indoor air/surface temperatures and air speeds at windows can be taken as often as every second.

Figure 3. (a) Hobo U12 data logger, (b) surface temperature, (c) air speed and (d) thermal image taken by the camera.

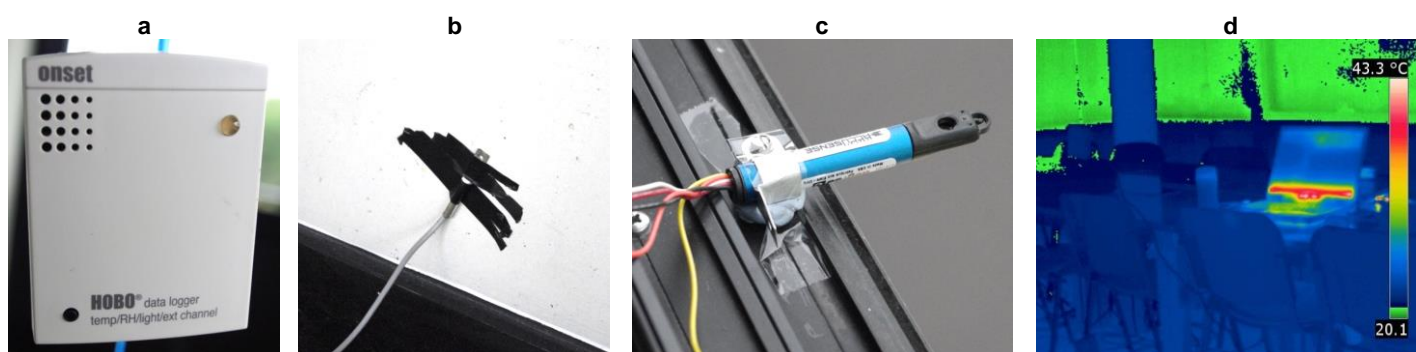

## 2.4. Weather monitoring

The measurement of outdoor weather conditions are provided by the automatic weather station [33] at the NUI Galway campus [36]. The weather station was specified and sourced in order to provide accurate real-time weather conditions in Galway city. This data supports the extensive research on the calibration of numerical models representing indoor conditions in operating buildings. The weather station was installed in July 2010 on the roof of one of the University buildings (in the centre of the campus). The weather station measures dry-bulb air temperature ( $^{\circ}\text{C}$ ) and relative humidity (RH) (%), barometric pressure (mBar), wind speed (m/s) and wind direction ( $^{\circ}$ ), global and diffuse solar irradiance ( $\text{W/m}^2$ ) and rainfall (mm). The type and accuracy of the weather station sensors are listed in Table 1.

**Please reference as:**

**Hajdukiewicz, M., Byrne, D., Keane, M.M., & Goggins, J., 2015. 'Real-time monitoring framework to investigate the environmental and structural building performance'. *Building and Environment*, 86, pp. 1-16. <http://dx.doi.org/10.1016/j.buildenv.2014.12.012>**

Table 1. The accuracy of the weather station sensors.

Measurement	Sensor type	Accuracy
Dry-bulb air temperature	HMP45AC – Vaisala Oyj, Finland	$\pm 0.13$ °C
Relative humidity	HMP45AC – Vaisala Oyj, Finland (with Vaisala's HUMICAP RH sensor)	$\pm 1.0\%$ @ 0% - 15% RH; $\pm 1.5\%$ @ 15% - 78% RH
Wind direction	W200P-1 Potentiometer Wind vane	$\pm 2^\circ$ (in steady winds over 5 m/s)
Wind speed	A100R Switching Anemometer	$\pm 0.1$ m/s (0.3 - 10 m/s); $\pm 1\%$ (10 - 55 m/s); $\pm 2\%$ (> 55 m/s)
Rainfall	ARG100 – Campbell Scientific	0.2 mm/tip
Barometric pressure	Model CS100 – Setra SetraceraTM	$\pm 0.5$ mb @ + 20 °C; $\pm 1.0$ mb @ 0 to 40 °C; $\pm 1.5$ mb @ -20 to + 50 °C; $\pm 2.0$ mb @ -40 to + 60 °C
Global solar irradiation	BF3H-UM-1.0 – Delta-T Devices Ltd.	$\pm 5$ W/m <sup>2</sup> $\pm 12\%$
Diffuse solar irradiation	BF3H-UM-1.0 – Delta-T Devices Ltd.	$\pm 20$ W/m <sup>2</sup> $\pm 15\%$

The data logger, with a compact flash memory card, records and stores the weather data. The Ethernet module allows for downloading data via an internet connection. The data collection time step is 1 minute for all sensors except rainfall, for which it is 1 hour.

The weather station gives a reliable overview of the weather conditions in Galway (it is the only weather station in Galway city with high accuracy sensors). The live and historical weather data measured by the station are maintained by the Informatics Research Unit for Sustainable Engineering (IRUSE) at NUI Galway and can be accessed by general public online [36] or by using a smart phone application [37].

## 2.5. Laboratory experiments

The comprehensive material testing campaign complements the real-time measurements in the operating buildings. Those experiments are carried out in order to accurately specify the structural and thermal properties of precast and in situ concrete used in the demonstration buildings (EB and ILAS building). Concrete specimens in a shape of cylinders, cubes or prisms specimens are tested in order to establish their properties [38]. Those laboratory experiments include density, compressive [39] and tensile [40] strengths, modulus of elasticity [41], coefficient of thermal expansion [42] and thermal conductivity [43] (Figure 4).

Data obtained from the laboratory testing is analysed for quality control, comparison with the building design specifications and research purposes. Table 2 shows a sample testing regime for the in situ concrete mix in the ILAS building [44].

### Please reference as:

**Hajdukiewicz, M., Byrne, D., Keane, M.M., & Goggins, J., 2015. 'Real-time monitoring framework to investigate the environmental and structural building performance'. *Building and Environment*, 86, pp. 1-16. <http://dx.doi.org/10.1016/j.buildenv.2014.12.012>**

Figure 4. Laboratory experiments to determine the properties of concrete.

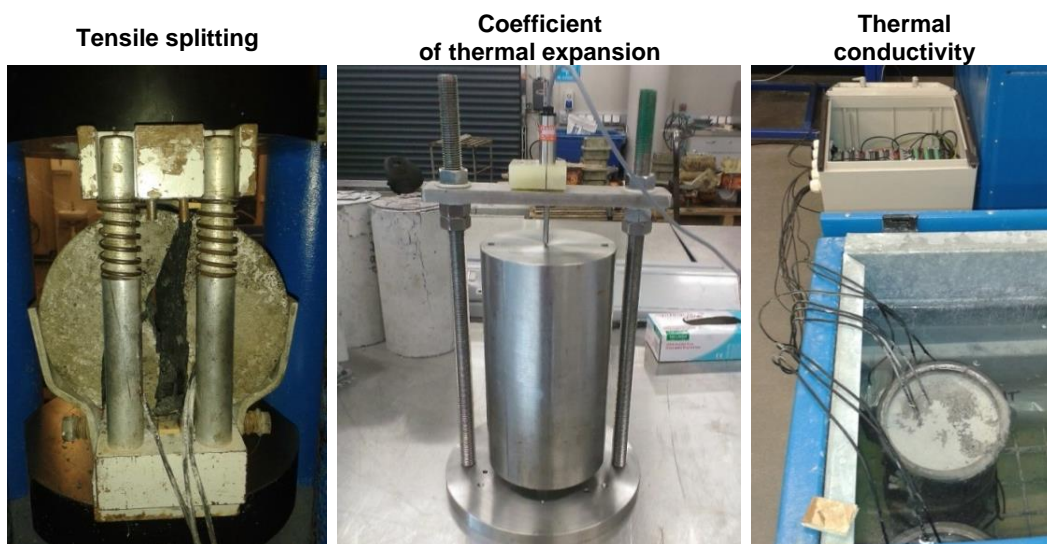

Table 2. Testing schedule for the in situ concrete mix from the ILAS building [44].

Materials testing	Cubes 100 mm x 100 mm	Cylinders 150 mm (D) x 300 mm (H)
Compressive strength test (3, 7, 14, 28, 56, 112, 365 days)	√	√
Tensile splitting test (28 days)	-	√
Modulus of elasticity (7, 28, 56, 112 days)	-	√
Coefficient of thermal expansion	-	√
Density and specific gravity (all specimens)	√	√
Specimen left on site with embedded thermistor to measure temperature	-	√

### 3. Demonstrator 1: Engineering Building

#### 3.1. Overview of the building

The first demonstrator utilised in the development of the real-time monitoring framework is the Engineering Building (EB) at the NUI Galway (Figure 5). This state of the art academic facility integrates all engineering activities on campus. The 14 250 m<sup>2</sup> building was opened to public in July 2011 and accommodates over 1 100 students and 110 staff. The

**Please reference as:**

**Hajdukiewicz, M., Byrne, D., Keane, M.M., & Goggins, J., 2015. 'Real-time monitoring framework to investigate the environmental and structural building performance'. *Building and Environment*, 86, pp. 1-16. <http://dx.doi.org/10.1016/j.buildenv.2014.12.012>**

EB is predominantly naturally ventilated and utilises a range of sustainable technologies. Materials, such as zinc or low-carbon cement replacements (ground granulated blast furnace slag (GGBS)), and technologies, such as a novel void form flat slab system (VFFS) (Figure 6), have been used in the construction of the building to minimise its embodied energy. For the heating and ventilation purposes, apart from the passive ventilation, there are installed: (i) a combined heat and power unit, (ii) high-efficiency natural gas condensing boilers, (iii) a biomass boiler and (iv) a ground source heat pump. The building utilises a large scale rainwater harvesting system for the water recycling purposes and water attenuation (grass roof and water attenuation tank) to reduce the water discharge to the city sewers. Finally, the use of low-energy lighting, lighting controls (based on occupancy and time of the day) and smart metering (indoor environmental conditions, energy, water) complements the overall 'green' performance of the EB.

Figure 5. The front façade (top) and the 3<sup>rd</sup> floor plan (bottom) of the Engineering Building (EB) at NUI Galway.

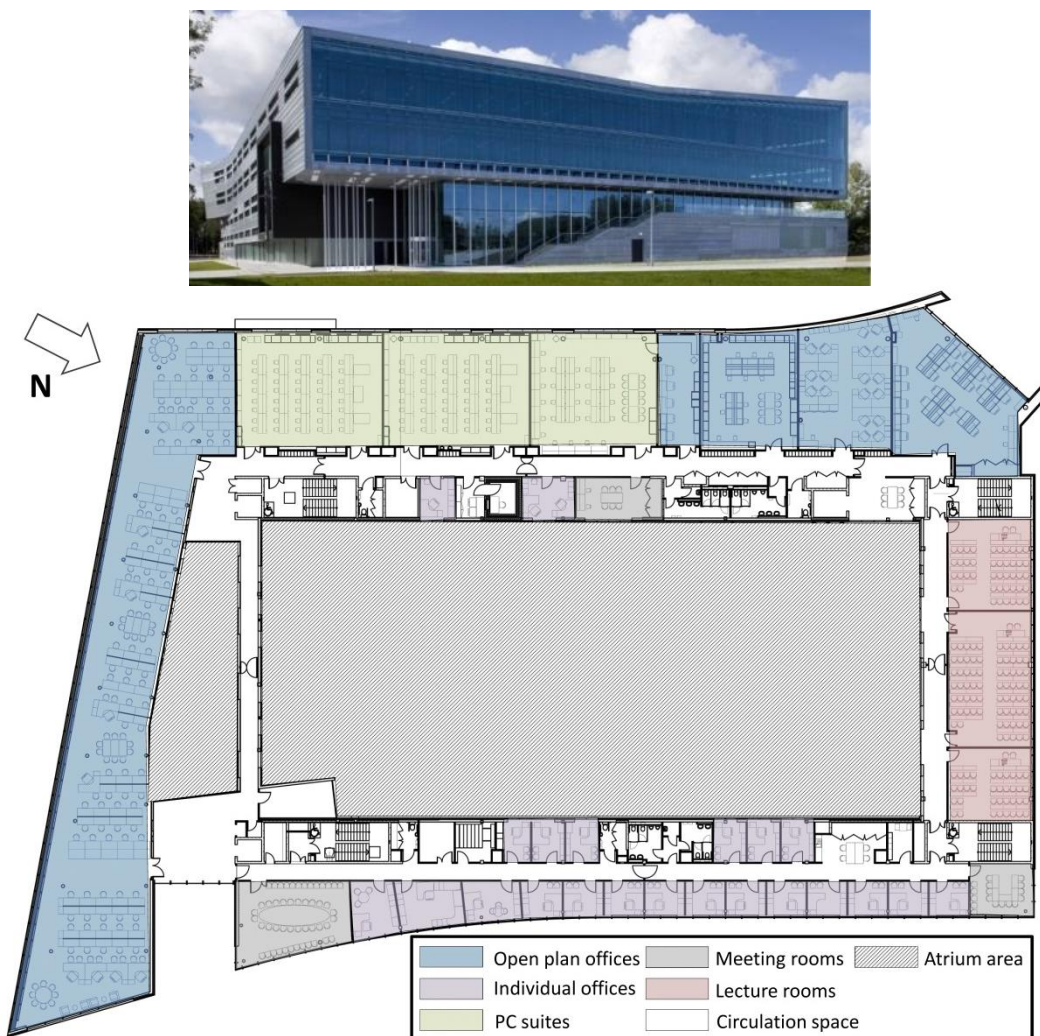

**Please reference as:**  
**Hajdukiewicz, M., Byrne, D., Keane, M.M., & Goggins, J., 2015. 'Real-time monitoring framework to investigate the environmental and structural building performance'. *Building and Environment*, 86, pp. 1-16. <http://dx.doi.org/10.1016/j.buildenv.2014.12.012>**

The EB provides a learning environment and also acts as a teaching/learning tool. The building is a 'living laboratory' for engineering [45], where live data sets from numerous types of sensors are provided to illustrate structural and environmental building performance concepts in undergraduate teaching and in the development of full-scale research. Structural and environmental characteristics of the building are systematically captured, transformed and monitored throughout the building's entire life cycle. Those characteristics include the measurement of building's (i) structural behaviour (strains, temperatures and movements in the building structure); (ii) energy demands (electrical loads such as lighting, computing and HVAC equipment); and (iii) environmental behaviour (thermal comfort, air quality and water consumption). The information gathered from the building is then used to create interactive tools for students, form the basis for ongoing/future research projects and facilitate the advancement of engineering teaching methods.

### 3.2. Structural performance

One of the cutting-edge technologies employed in the EB is the VFFS built using the Cobiax system technology [46]. The reinforced concrete slabs contain high-density polyethylene hollow void formers to replace concrete over the middle height of the slab, where the slab primarily experiences bending stresses with relatively low shear stresses (Figure 6). Those hollow void formers not only reduce the structural dead load of the slab (resulting in saving on the material cost and allowing larger slab spans), but also increase the thermal resistance of the slab.

Figure 6. Cobiax VFFS system being installed in the EB (left) and with gauges installed (right) [47].

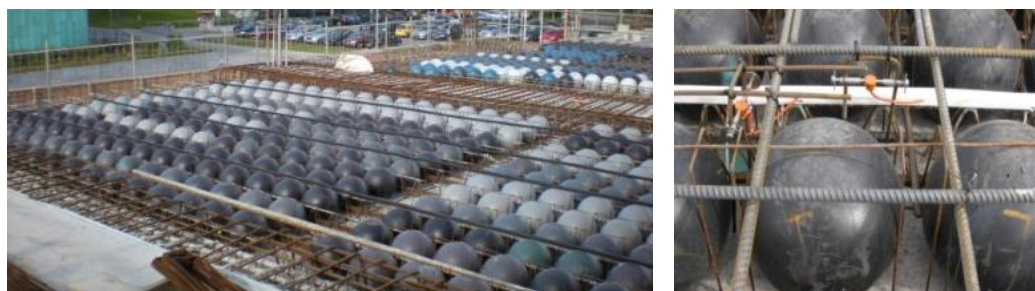

This novel form of flat slab system was implemented for the first time on a large scale project in Ireland in the EB. The VFFS instrumented in the EB is a floor slab located on the third floor in the west wing of the building. The slab (12.65 m x 7.50 m) consists of the precast lattice girder element manufactured off site and an in situ element (Figure 7). The bottom surface of the slab is exposed (with no finish applied to it), while the top surface of the slab is hidden under the suspended panel floor.

There are 164 sensors embedded in this Cobiax slab, i.e. 64 VW gauges [30] and 100 ER gauges [31] (Figure 7). The primary aim of embedding sensors in this novel form of slab was to investigate its structural two-way spanning

**Please reference as:**

**Hajdukiewicz, M., Byrne, D., Keane, M.M., & Goggins, J., 2015. 'Real-time monitoring framework to investigate the environmental and structural building performance'. *Building and Environment*, 86, pp. 1-16. <http://dx.doi.org/10.1016/j.buildenv.2014.12.012>**

action and, in particular, the shear transfer over the precast joints and time-dependent effects, such as temperature, creep and shrinkage. However, the sensors are also used for investigating the thermal performance of the structure with respect to internal comfort of the room occupants (see Section 3.3).

Large prestressed transfer beams are utilised in the EB in order to provide the 3<sup>rd</sup> floor slab system over the high-bay (up to 30 m) and long-span (up to 17 m) spaces that accommodate main lecture halls. Those prestressed beams include double tee units and box beam units; one of each were instrumented with embedded strain and temperature sensors during manufacture (Figure 8). The double tee unit consists of two prestressed ribs connected by a thin top slab. The in situ screed on top of the unit allows for load sharing in the building structure. In the EB the double tee unit with a span of 16.37 m and width of 3.18 m is installed in the high-bay areas of the lecture halls. There are 39 VW gauges installed in this unit (Figure 8). The aim of embedding sensors in the double tee unit was to monitor the time-dependent effects of creep, shrinkage and temperature on prestressing losses, and the response of the unit to loading and the external environmental conditions during construction and in use.

Figure 7. Section (top) and plan (bottom) of the Cobiast slab showing the location of VW gauges (red) and ER gauges (dashed blue) [47] (dimensions in mm).

**Please reference as:**

**Hajdukiewicz, M., Byrne, D., Keane, M.M., & Goggins, J., 2015. 'Real-time monitoring framework to investigate the environmental and structural building performance'. *Building and Environment*, 86, pp. 1-16. <http://dx.doi.org/10.1016/j.buildenv.2014.12.012>**

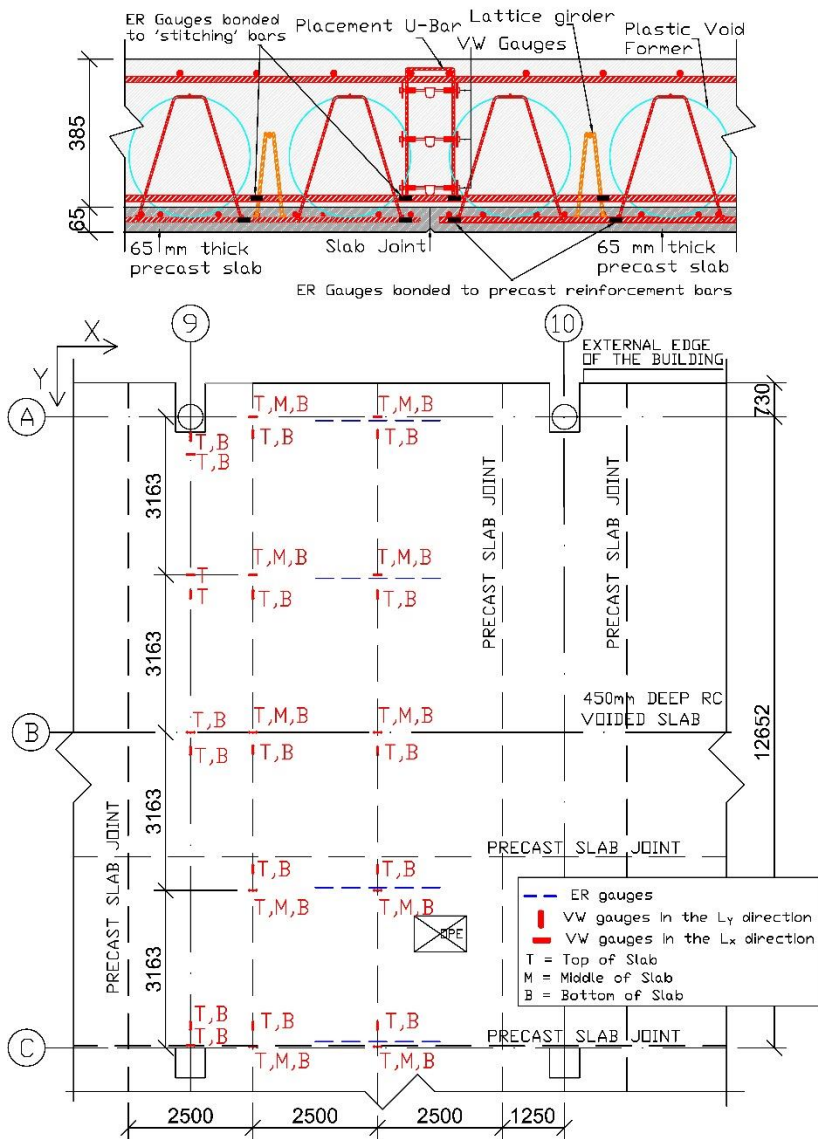

The 0.97 m x 1.20 m prestressed box beam spans over 16.37 m above the main lecture theatres in the EB and runs parallel to the double tee units. The beam transfers loads from the overhead 3<sup>rd</sup> floor to supporting reinforced concrete columns located at either end of the beam. The box beam is instrumented with 57 VW gauges distributed over 7 different sections (depending on the loading conditions along the beam's span). The aim of embedding sensors in this box beam was to monitor the time-dependent effects and thermal response of the structure to external ambient and environmental conditions. Furthermore, the building has been designed to accommodate the construction of an additional storey in this section of the building in future. Thus, the box beam had to be designed to perform adequately under existing conditions, but also be capable of transferring larger loads to supporting external columns in future. The historical data collected in the real time monitoring of this element will be useful in determining the structural health and additional capacity of this

**Please reference as:**

**Hajdukiewicz, M., Byrne, D., Keane, M.M., & Goggins, J., 2015. 'Real-time monitoring framework to investigate the environmental and structural building performance'. *Building and Environment*, 86, pp. 1-16. <http://dx.doi.org/10.1016/j.buildenv.2014.12.012>**

beam if the need arises to construct an additional floor on the building. This could lead to significant cost savings in the design and construction of an additional storey to the building.

Figure 8. Section view of the location of VW gauges (red) in (a) the double tee and (b) the box beam units (two out of seven sections) [47] (dimensions in mm).

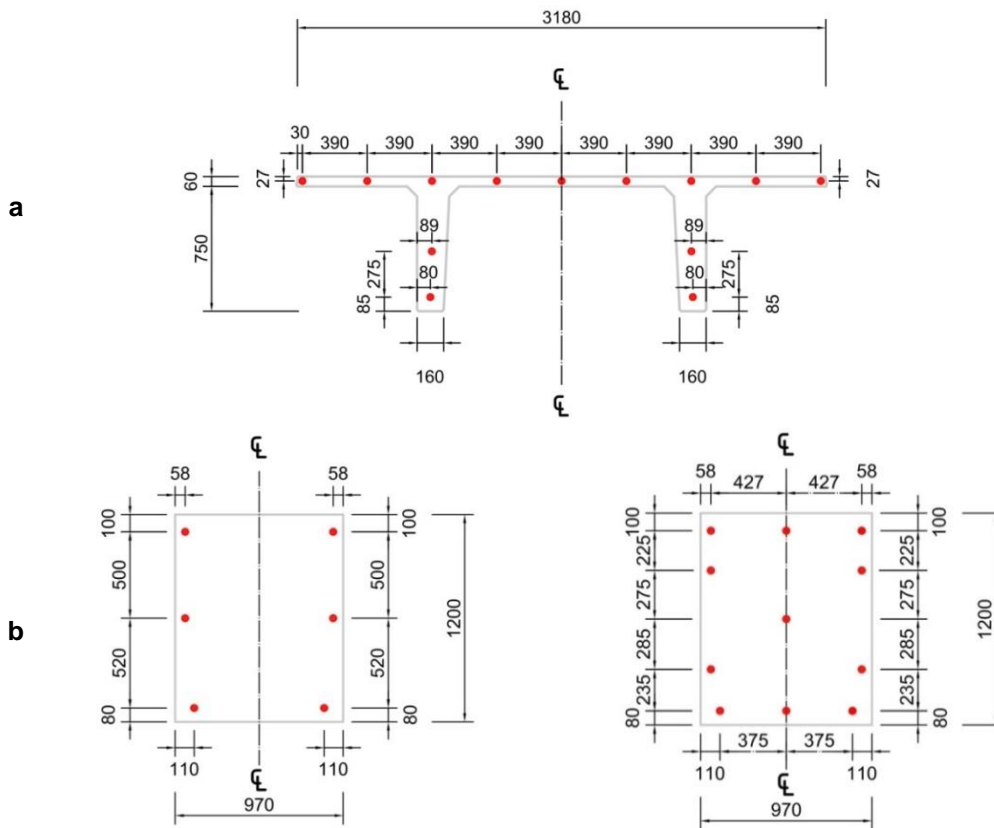

### 3.3. Environmental performance

The optimal operation of the EB is ensured through the Cylon BMS [48] that monitors (through approximately 4 000 sensors installed in the building) external weather conditions, indoor air temperatures, CO<sub>2</sub> concentrations, energy (78 individual electricity and 12 heat energy meters) and water consumption. In this mainly naturally ventilated building the BMS controls dampers and window openings depending on the indoor/outdoor conditions to provide optimal indoor environment for the building occupants. The lecture halls and computer suites are served by the air handling units (AHU) in order to maintain satisfactory air quality, air temperature and humidity. The BMS is equipped in a user friendly interface which displays live and recent historical building performance data and allows adjusting performance criteria.

Please reference as:

Hajdukiewicz, M., Byrne, D., Keane, M.M., & Goggins, J., 2015. 'Real-time monitoring framework to investigate the environmental and structural building performance'. *Building and Environment*, 86, pp. 1-16. <http://dx.doi.org/10.1016/j.buildenv.2014.12.012>

Furthermore, the long term historical BMS data has been stored in the MySQL [49] database since November 2011 and has been managed by IRUSE at NUI Galway [50].

Additional to the BMS and environmental indoor sensors, there are 64 VW gauges [30] installed in the Cobiast slab (Figure 6). Those VW gauges are equipped with the thermistor sensors and, thus, capable of measuring concrete temperature at various locations. This allows investigating the heat transfer and storage in this novel form of slab and the influence of those properties on the environmental conditions in the rooms above and below the slab.

### **3.4. Utilisation of measured data**

One of the key objectives of the structural / environmental instrumentation programme of the EB at NUI Galway was to analyse the thermal behaviour of the VFFS system and its respective structural response. The 64 VW gauges installed in the VFFS were used to measure both strain and temperature. In addition, ambient temperature was recorded using a separate VW gauge placed on top of the concrete slab. Measurements were recorded during construction and throughout the slabs service life and made it possible to establish a range of characteristics inherent to the slab system. The response of the slab system to thermal effects is of primary importance during the early curing stages. Temperature has a significant importance for concrete members due to induction of thermal stresses and strains within a member. Typically during design stage, the overriding concern will be to reduce these stresses and the potential for subsequent cracking during the early phases of curing. Large temperature differentials and high temperatures will be most prevalent during the early curing period of concrete, 1-3 days after pouring. This is when resultant temperatures are highest due to the exothermic chemical reaction from the hydration of CEM I cement. At this early stage the concrete has relatively low strength and as such is at a greater risk of cracking. A typical temperature profile for the first 13 days of curing at one of the instrumented sections in the VFFS is shown in Figure 9a. The heat of hydration effect is quite evident during the early days of curing where temperatures in the concrete clearly exceed ambient temperatures over the first four days of curing. It can be argued that the heat from the hydration does not fully dissipate until day 6, after which time the temperatures in the concrete are mainly responsive to the ambient diurnal temperatures. The impact of ambient temperatures on the concrete temperature and the diurnal response of the slab is something that is evident throughout the life of the slab. Another key point to note is the reduced maximum temperature due to the presence of 50% GGBS in the concrete mix. This not only helps to reduce the carbon footprint of the mix but also the heat generated during curing. Based on the properties of the mix and the relevant temperature data a peak temperature of over 40 °C could be expected if 100% CEM I cement was used [51].

#### **Please reference as:**

**Hajdukiewicz, M., Byrne, D., Keane, M.M., & Goggins, J., 2015. 'Real-time monitoring framework to investigate the environmental and structural building performance'. *Building and Environment*, 86, pp. 1-16. <http://dx.doi.org/10.1016/j.buildenv.2014.12.012>**

Another key point to note from Figure 9a is the distinct temperature variation over the concrete cross-section and the differentials which occur between gauges in the top, middle and bottom of the slab. Not only do they reach different maximum and minimum temperatures but these temperatures also occur at different times throughout the day to their corresponding ambient temperatures. This is clear evidence of thermal mass in operation. These temperature differentials lead to the development of thermal gradients across the slab and in effect, internal restraint within the concrete section. As such, the thermal gradient leads to curling and warping of the slab as the concrete heats and cools at different rates. This then leads to the formation of bending deformations and increased stresses. It is evident from Figure 9a that the maximum temperature was achieved in the middle gauge during the first day of curing and this was consistent across the slab bay. However, every subsequent day thereafter, the maximum and minimum temperatures were experienced in the top gauges. The largest temperature differential over a given day during these early curing phases was 16 °C and experienced in the top of the slab. In fact temperature differentials were significantly greater in the top gauges across the slab. In contrast, the minimum temperature differential (1 °C) during this early curing period occurred within the middle of the slab. Temperature differential in the gauges were slightly lower in the bottom gauges than those in the top section with a maximum temperature differential of 12 °C. When analysing the standard deviation and respective variance in readings the bottom gauges were found to be consistently higher. While the temperature differential was smaller than in the top section the readings were far more varied. Although this large differential occurred during the predominant phase of hydration this was still a common effect when the heat of hydration had dissipated. When analysing the behaviour of the slab it was found that thermal gradients did not just occur vertically across the section but also horizontally. For the day on which the maximum temperature differential of 16 °C occurred in the top section a similar gauge in the same plane experienced a differential of just 5 °C, giving a difference of 11 °C. It was not quite clear why there was such a difference in the horizontal temperature differentials. The gauge with the lower differential was located in an area of the slab where there was a distinct change in the void layout of the slab. To meet shear requirements for design a large number of voids were removed from this region and, in essence, also affected the thermal response of the slab. It is apparent however, that this phenomenon was predominant during the heat of hydration phase. After the heat of hydration began to dissipate the average difference between the horizontal temperature differentials was close to 2 °C and after the building was enclosed this reduced further to under 1 °C. As already mentioned temperature differentials of up to 16 °C were experienced during the early curing phases. It is these large temperature differentials which are necessary in assessing the cracking potential of the slab system. If a coefficient of thermal expansion of  $10 \mu\epsilon/^\circ\text{C}$  is used, which is in accordance with Eurocode 2 (EC2) [52], then this

**Please reference as:**

**Hajdukiewicz, M., Byrne, D., Keane, M.M., & Goggins, J., 2015. 'Real-time monitoring framework to investigate the environmental and structural building performance'. *Building and Environment*, 86, pp. 1-16. <http://dx.doi.org/10.1016/j.buildenv.2014.12.012>**

equates to strains in excess of  $160 \mu\epsilon$ . This is close to, and in some cases slightly exceeds, the theoretical tensile strain capacity of concrete. Excessive cracking, especially at such an early age, can lead to serviceability issues with the slab system. By calculating the tensile strain capacity outlined by both EC2 [52] and American Concrete Institute (ACI) [53] standards it was possible to identify areas of the VFFS which may be prone to and have experienced cracking. Strain profiles over each section were plotted and compared with the relative tensile strain capacities outlined by the respective standards. Upon analysis it was found that only one instrumented section exceeded the tensile strain capacity of the concrete in line with the standards. This occurred at the mid-span section, in the short span direction of the slab and the strain profile is shown in Figure 9b. By monitoring the behaviour of the gauges at the section it was possible to determine if in fact cracking had occurred (cracked sections behave considerably different to uncracked sections). After analysis it was deemed the section was not cracked. The relevant strain profiles could then be converted to respective stresses, again using procedures outlined by both EC2 [52] and ACI [53] standards. The respective stresses essentially follow the strain profiles and have a close correlation to the behaviour of the temperature differentials. The maximum compressive stress experienced during these early curing phases was  $3.77 \text{ N/mm}^2$  and located in one of the top gauges in the middle section of the slab. The maximum tensile stress of  $1.97 \text{ N/mm}^2$  corresponded to the bottom gauge in the mid-section where the maximum strain was experienced. Overall average maximum compression readings in the top gauges over this period were  $2.14 \text{ N/mm}^2$  with maximum tension readings  $0.81 \text{ N/mm}^2$ . Top gauges were predominantly affected by compressive stresses. In contrast, gauges in the middle and bottom sections were predominately affected by tensile stresses with larger tensile stresses occurring in the middle gauges ( $1.62 \text{ N/mm}^2$ ) compares to the bottom gauges ( $1.38 \text{ N/mm}^2$ ).

Figure 9. (a) Typical temperature profile at one of the instrumented sections in the VFFS unit and (b) strain profile at one of the instrumented sections.

**Please reference as:**

**Hajdukiewicz, M., Byrne, D., Keane, M.M., & Goggins, J., 2015. 'Real-time monitoring framework to investigate the environmental and structural building performance'. *Building and Environment*, 86, pp. 1-16. <http://dx.doi.org/10.1016/j.buildenv.2014.12.012>**

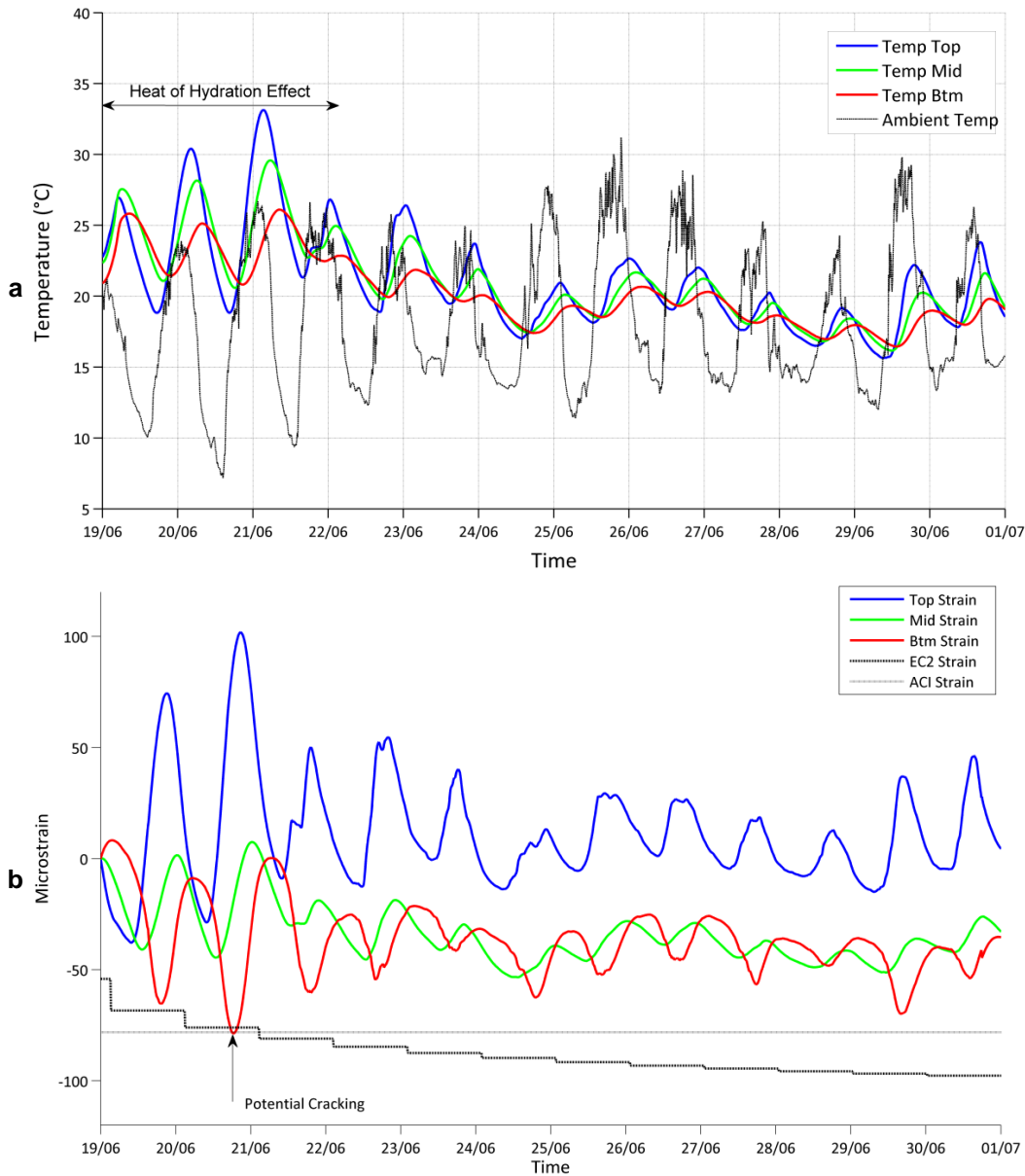

Long term analysis of the temperature data from the VW gauges was also carried out and it has been possible to identify five distinct thermal phases from the VFFS to date. These were:

- 1) Heat of hydration effect during the first four days of curing;
- 2) Exposure to external ambient environment (from casting until the installation of external cladding during week 7);
- 3) Internal ambient environment (from week 7 until week 25, just before Christmas 2010);
- 4) Heating of building during the final construction phase (from week 25 to week 74);
- 5) Operational phase of the building (from week 74 to present).

**Please reference as:**

**Hajdukiewicz, M., Byrne, D., Keane, M.M., & Goggins, J., 2015. 'Real-time monitoring framework to investigate the environmental and structural building performance'. *Building and Environment*, 86, pp. 1-16. <http://dx.doi.org/10.1016/j.buildenv.2014.12.012>**

Table 3 gives the temperature history for the overall slab in addition to the ambient temperature for each month of the slabs life from June 2010 up until May 2013. It is quite evident from the standard deviation values that there was significant variation in temperatures during the early months of curing, particularly in June and July 2010 when the slab was exposed to external conditions. This corresponded to the heat of hydration and external ambient conditions from the first two thermal phases. After the installation of external cladding in early August 2010, there was a significant reduction in temperature fluctuations, but more importantly, a steady drop in mean temperatures from August 2010 until heating of the building was initiated in December 2010. After December 2010, temperatures remained relatively constant with very small fluctuations between maximum and minimum readings. This corresponded to thermal phases four and five and in reality there was very little difference between the behaviour during those phases. Phase 5 tended to have a slightly higher average temperature compared to Phase 4 and was also more dependent on the operational behaviour of the building.

Table 3. Temperature history of VFFS unit.

2010												
	Jun	Jul	Aug	Sept	Oct	Nov	Dec					
<b>Slab Temperature</b>												
Avg. High (°C)	30	23	19	20	17	14	23					
Daily Mean (°C)	22	16	17	17	15	13	18					
Avg. Low (°C)	14	13	16	15	13	11	12					
Std. Dev.	3.26	1.47	0.62	1.21	1.08	0.85	2.66					
<b>Ambient Temperature</b>												
Avg. High (°C)	31	25	23	20	17	18	24					
Daily Mean (°C)	18	15	15	15	13	10	16					
Avg Low (°C)	7	10	11	11	10	8	11					
Std. Dev.	2.20	1.38	1.58	1.25	1.01	2.40	2.20					
2011												
	Jan	Feb	Mar	Apr	May	Jun	Jul	Aug	Sept	Oct	Nov	Dec
<b>Slab Temperature</b>												
Avg. High (°C)	22	24	26	22	23	22	22	21	22	22	22	22
Daily Mean (°C)	20	21	22	21	21	20	21	21	21	21	22	20
Avg. Low (°C)	18	16	19	17	20	19	20	20	20	20	21	19
Std. Dev.	0.75	1.69	1.61	0.63	0.95	0.76	0.44	0.36	0.44	0.52	0.41	0.70
<b>Ambient Temperature</b>												
Avg. High (°C)	20	21	25	22	23	22	22	21	22	22	23	22
Daily Mean (°C)	19	20	22	21	21	20	21	20	20	21	22	20
Avg. Low (°C)	17	15	18	20	19	18	20	20	18	18	20	18
Std. Dev.	0.50	1.50	1.44	0.40	0.73	0.90	0.38	0.40	0.60	0.75	0.49	1.02
2012												
	Jan	Feb	Mar	Apr	May	Jun	Jul	Aug	Sept	Oct	Nov	Dec
<b>Slab Temperature</b>												
Avg. High (°C)	21	22	23	23	24	23	23	23	22	22	23	23
Daily Mean (°C)	20	21	22	22	22	22	22	22	21	21	22	22
Avg. Low (°C)	18	20	21	21	21	22	21	21	20	20	20	20
Std. Dev.	1.11	0.46	0.41	0.48	0.59	0.26	0.43	0.76	0.42	0.53	0.68	0.72
<b>Ambient Temperature</b>												
Avg. High (°C)	22	22	23	23	24	23	22	23	22	23	23	23
Daily Mean (°C)	20	21	22	22	22	22	22	22	21	21	21	22
Avg. Low (°C)	17	16	17	18	19	20	21	20	18	18	18	19
Std. Dev.	1.49	1.19	0.57	0.69	0.71	0.35	0.30	0.85	0.75	1.00	1.02	0.85
2013												
	Jan	Feb	Mar	Apr	May							
<b>Slab Temperature</b>												
Avg. High (°C)	22	23	23	22	23							
Daily Mean (°C)	21	21	22	22	22							

Please reference as:

Hajdukiewicz, M., Byrne, D., Keane, M.M., & Goggins, J., 2015. 'Real-time monitoring framework to investigate the environmental and structural building performance'. *Building and Environment*, 86, pp. 1-16. <http://dx.doi.org/10.1016/j.buildenv.2014.12.012>

Avg. Low (°C)	20	19	21	20	21
Std. Dev.	0.74	0.74	0.36	0.54	0.54
<b>Ambient Temperature</b>					
Avg. High (°C)	22	23	23	22	23
Daily Mean (°C)	21	21	22	21	22
Avg Low (°C)	19	16	18	18	20
Std. Dev.	0.71	1.31	0.66	0.70	0.61

Figure 10 illustrates the comparison between the average temperatures experienced in the slab and the corresponding ambient temperatures over the period monitored. It is possible to identify some of the thermal phases from the figure, namely Phases 1, 2 and 3, where there are large differentials between slab and ambient temperatures. It is also quite clear when heating of the building was initiated in December 2010, with subsequent slab and ambient temperatures showing close correlation for both maximum and average measurements. This corresponds to Phases 4 and 5 which show more consistent temperature behaviour. It can be seen, however, that there is a distinct difference between minimum temperatures experienced in the slab and corresponding ambient temperatures. The average minimum slab temperature never dropped to the minimum ambient temperature, almost always maintaining a significant differential. This again is an evidence of thermal mass in operation.

Figure 10. Visual representation of (a) maximum, (b) minimum and (c) average temperature data from VFFS unit.

**Please reference as:**

**Hajdukiewicz, M., Byrne, D., Keane, M.M., & Goggins, J., 2015. 'Real-time monitoring framework to investigate the environmental and structural building performance'. *Building and Environment*, 86, pp. 1-16. <http://dx.doi.org/10.1016/j.buildenv.2014.12.012>**

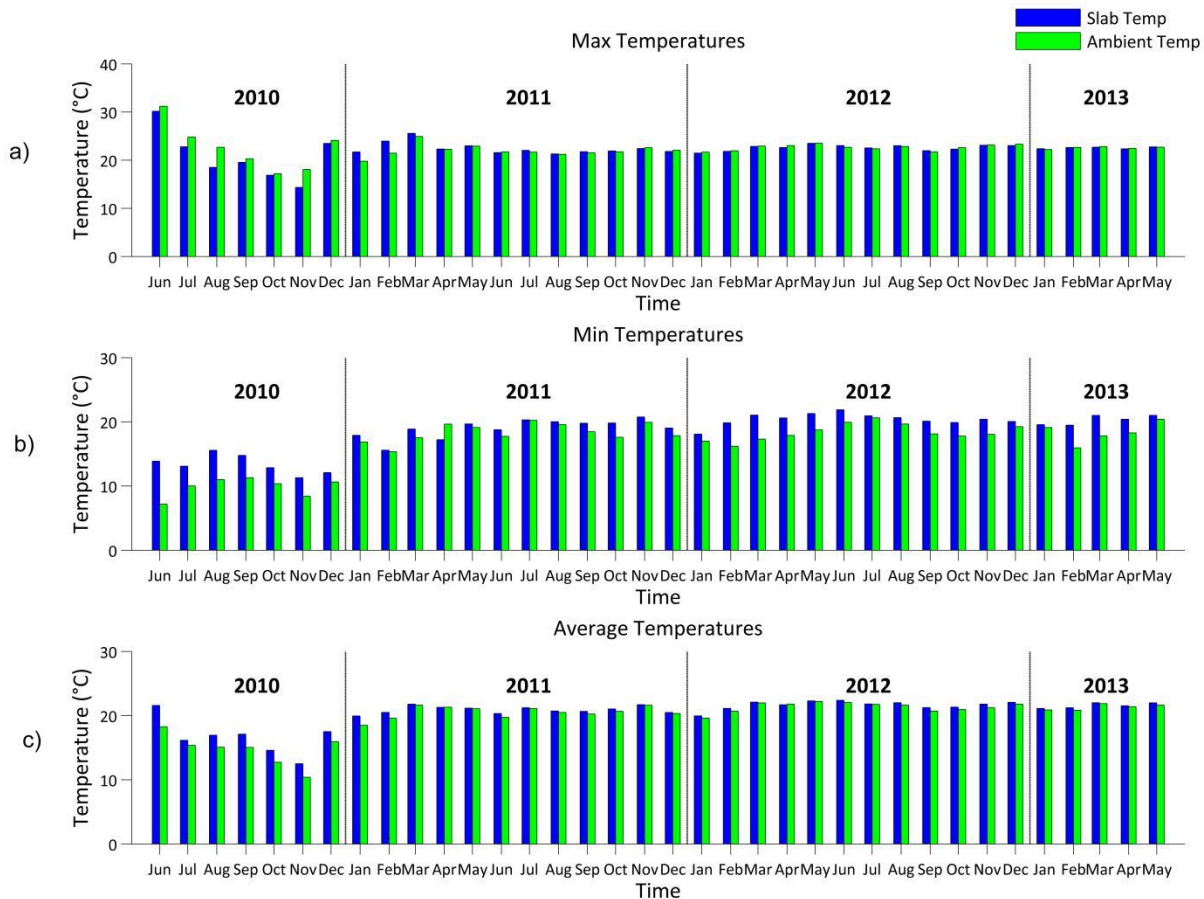

The real-time data of the EB obtained from the BMS, sensors embedded in the building's structure and additional indoor sensors (Section 2) provide an invaluable resource for education and research relating to the building's structural and environmental performance. From the educational perspective, the EB has provided critical information to support the development of undergraduate modules, final year projects and summer internships. The topics range from the utilisation of concrete structural elements' properties to minimise the energy usage in buildings [54], through to the investigation of the real-time control strategies in smart buildings [55], to analysis of time dependent effects of concrete systems [56] and determining optimum retrofitting solutions of concrete structural elements [57]. Moreover, the EB real-time data have formed a strong basis for the ongoing research projects, such as the generation of calibrated numerical models (see, for example, Figure 11) that (i) investigate the building's energy/ventilation performance and their influence on the occupants thermal comfort [58]–[60] and (ii) investigate the structural performance of novel hybrid precast and in situ reinforced concrete systems [47].

Figure 11. The computational fluid dynamics model (left) and the conjugate heat transfer model (right) of systems in the EB.

**Please reference as:**  
**Hajdukiewicz, M., Byrne, D., Keane, M.M., & Goggins, J., 2015. 'Real-time monitoring framework to investigate the environmental and structural building performance'. *Building and Environment*, 86, pp. 1-16. <http://dx.doi.org/10.1016/j.buildenv.2014.12.012>**

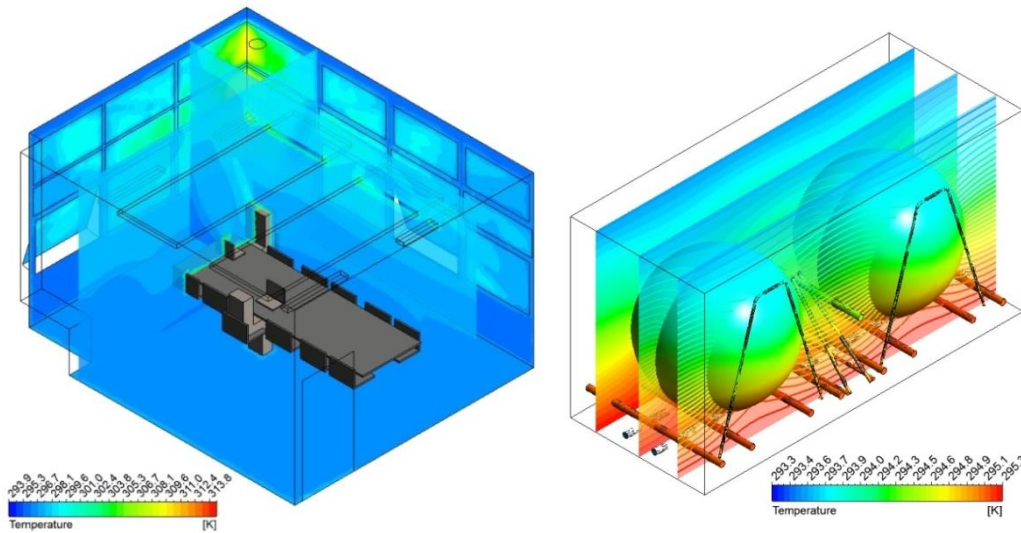

## 4. Demonstrator 2: Institute for Lifecourse and Society building

### 4.1. Overview of the building

The second demonstrator that supports the real-time monitoring framework is the Institute for Lifecourse and Society (ILAS) building at NUI Galway (Figure 12). This building is used in the research in order to analyse the performance of precast concrete building structural elements and the influence of their properties on indoor environments. At the time of writing this paper the ILAS building is still under construction, which commenced in July 2013 and is expected to be completed by September 2014. The building occupies a gross floor area of about 3 600 m<sup>2</sup> and has been built with two separate wings (two storeys high East wing and three storeys high West wing) designed around a large central atrium (Figure 12). The building accommodates mainly office spaces, seminar rooms and lecture theatres and operates with a mixed mode ventilation system. The part of the building accommodating offices is naturally ventilated, while the seminar rooms and lecture theatres are air conditioned and controlled by the BMS.

The ILAS building is mainly built in the precast concrete technology [61], including the building frame, twinwall system, lattice (also known as filigree slabs) and hollowcore slabs. Precast concrete solutions increase the speed of building erection on site, while maintaining the site safer and cleaner when compared to standard construction methods.

**Please reference as:**

**Hajdukiewicz, M., Byrne, D., Keane, M.M., & Goggins, J., 2015. 'Real-time monitoring framework to investigate the environmental and structural building performance'. *Building and Environment*, 86, pp. 1-16. <http://dx.doi.org/10.1016/j.buildenv.2014.12.012>**

Figure 12. The photomontage (top) and the 1<sup>st</sup> floor plan (bottom) of the Institute for Lifecourse and Society (ILAS) building at NUI Galway.

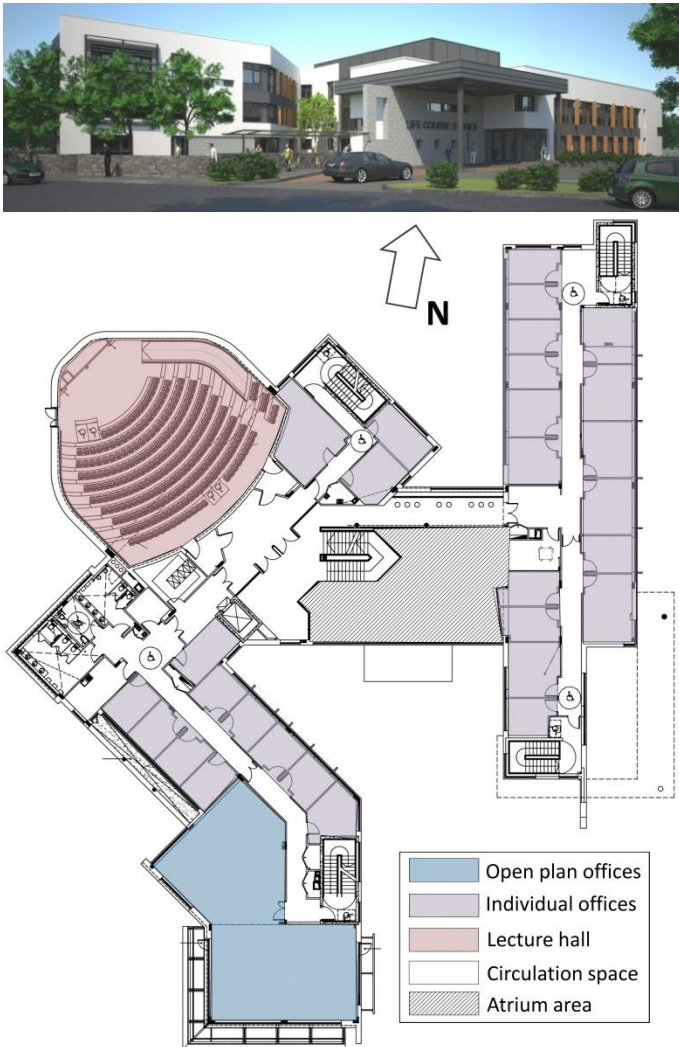

#### 4.2. Structural performance

The 300 mm deep flat slab forming the first floor of the East wing of the ILAS contains 59 VW gauges installed over 29 designated sections (Figure 13). The instrumented slab is an interior, two-way spanning slab (of multiple spans) spanning 8.14 m in one direction and has two spans of 5.81 m and 4.21 m in the orthogonal direction. The VW gauges in Figure 13 indicate strain measurements in the long ‘Lx’ and short ‘Ly’ span directions; ‘T’, ‘M’, ‘B’ and ‘P’ indicating the depth within the slab that the sensor is located (i.e. near the top, middle, bottom of the in situ component and in the precast biscuit, respectively). The aim of embedding sensors in this flat slab was to monitor the strains induced by

**Please reference as:**

**Hajdukiewicz, M., Byrne, D., Keane, M.M., & Goggins, J., 2015. ‘Real-time monitoring framework to investigate the environmental and structural building performance’. *Building and Environment*, 86, pp. 1-16. <http://dx.doi.org/10.1016/j.buildenv.2014.12.012>**



In order to monitor the thermal performance of structural elements in the ILAS building, over 120 temperature sensors (standalone thermistors and those built in the VW gauges (Figure 2)) are embedded in the in the precast and in situ parts of the internal and external walls; ground floor hollowcore and in situ slabs; internal and roof slabs.

This paper shows the installation details of the thermistors embedded in three representative building elements: (i) first floor external twinwall (West wing), (ii) lattice roof slab (East wing), and (iii) suspended ground floor hollowcore slab (East wing) (0.5 m void, naturally ventilated with external air). Figure 14 shows the locations of thermistors in the plan/elevation and across the depth of the precast slab and wall elements, respectively. Thermistors are regularly located at one or two locations and three different depths of each wall/slab in order to measure the temperature distribution profile in the wall/slab. For the external twinwall, at locations 1 and 2, there is one thermistor placed in each of the precast biscuits (T1,2b,t) and one in the middle (T1,2m) of the in situ concrete. For the lattice roof slab, at locations 3 and 4, there is one thermistor placed in the precast biscuit (T4b, note: T3b & T4t were damaged during the precast manufacturing process) and two thermistors in the in situ part (T3m,t, T4m). Because of the manufacturing process of the ground floor hollowcore slab, thermistors were embedded into the finished slab by drilling holes and securing the sensors in locations 5 and 6.

Figure 14. Location of thermistors across the plan (left) and depth (right) of walls and slabs in the ILAS building (dimensions in mm) [60].

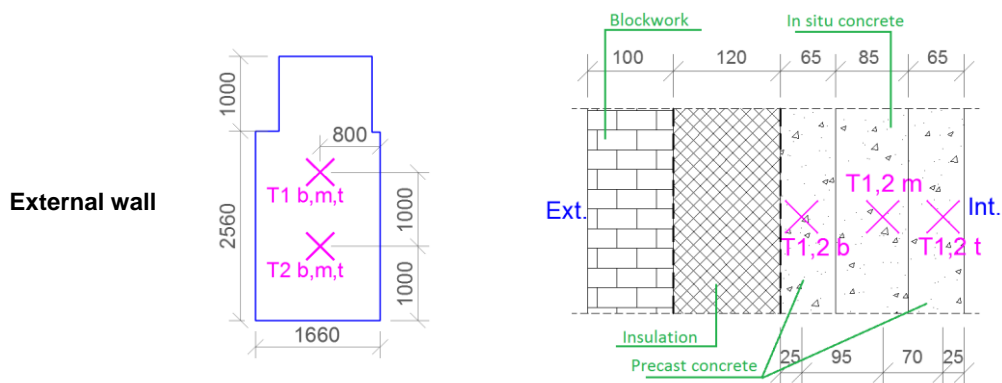

**Please reference as:**

**Hajdukiewicz, M., Byrne, D., Keane, M.M., & Goggins, J., 2015. 'Real-time monitoring framework to investigate the environmental and structural building performance'. *Building and Environment*, 86, pp. 1-16. <http://dx.doi.org/10.1016/j.buildenv.2014.12.012>**

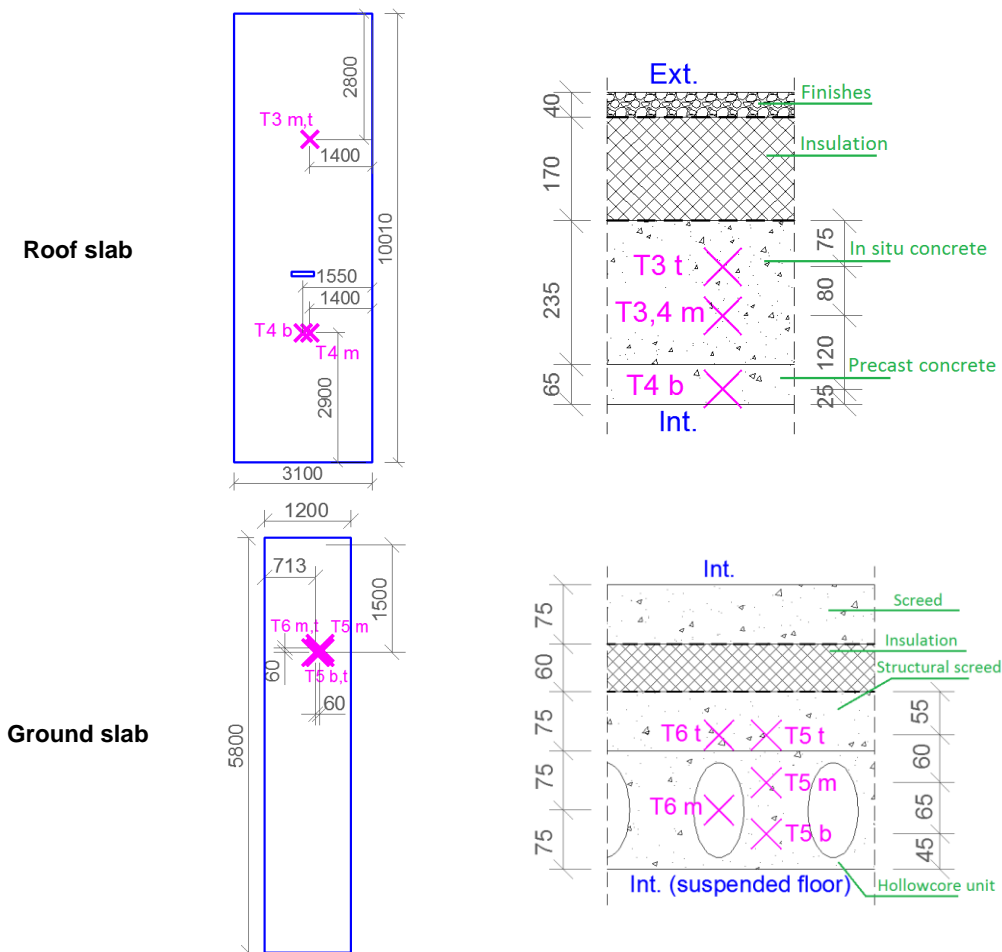
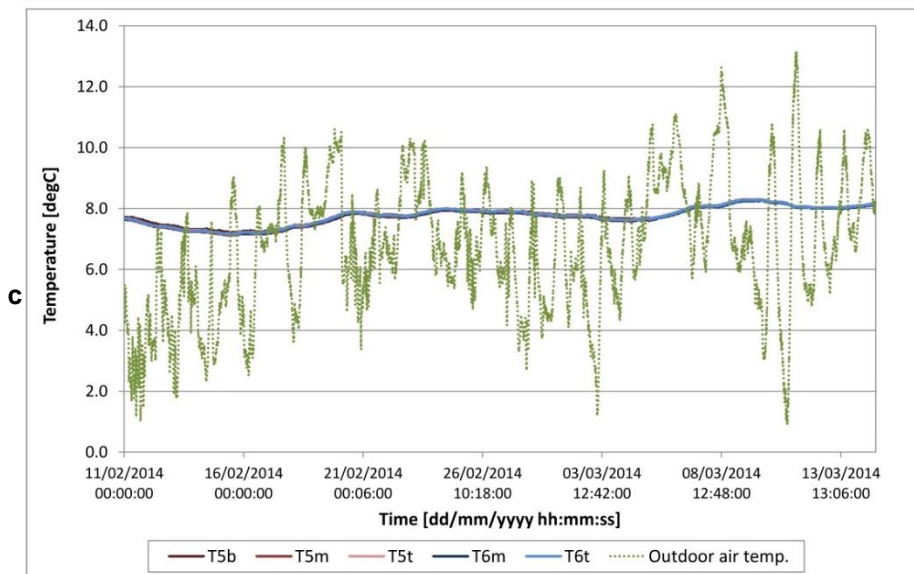
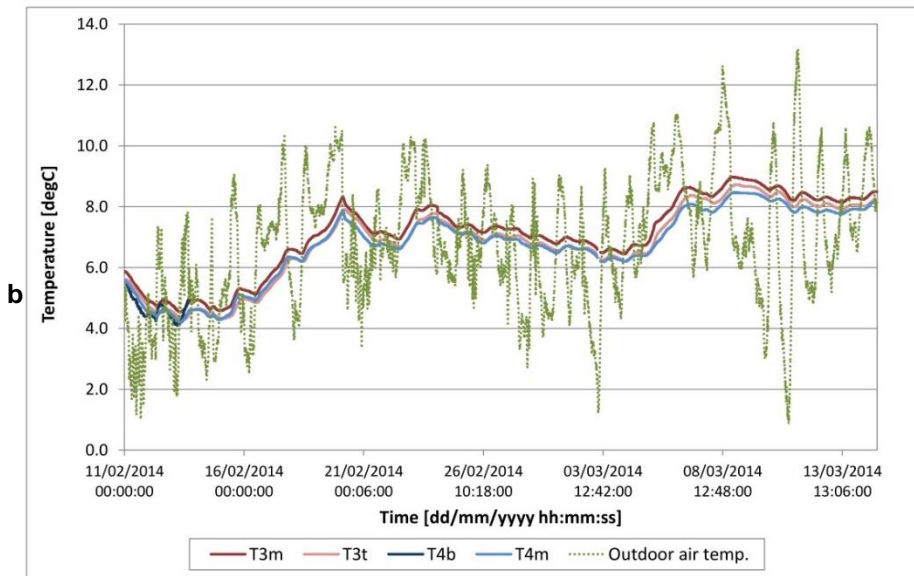
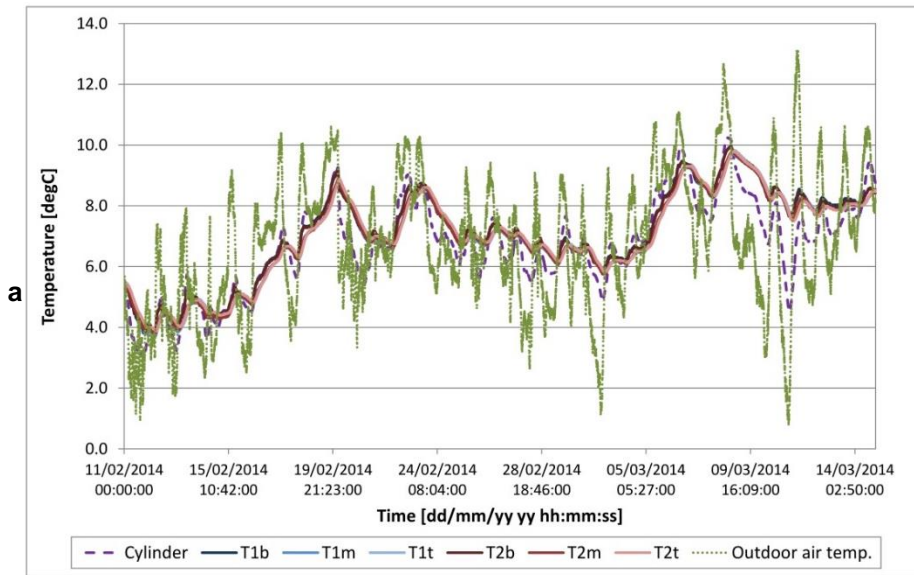

Figure 15 presents sample measurements obtained from the thermistors embedded in the external twinwall (T1, T2), roof lattice slab (T3, T4) and ground floor hollowcore slab (T5, T6) between February 11<sup>th</sup>, 2014 and March 15<sup>th</sup>, 2014.

Figure 15. Temperature distribution in the (a) external twinwall, (b) lattice roof slab and (c) ground floor hollowcore slab [60].

Please reference as:

Hajdukiewicz, M., Byrne, D., Keane, M.M., & Goggins, J., 2015. 'Real-time monitoring framework to investigate the environmental and structural building performance'. *Building and Environment*, 86, pp. 1-16. <http://dx.doi.org/10.1016/j.buildenv.2014.12.012>



Please reference as:  
 Hajdukiewicz, M., Byrne, D., Keane, M.M., & Goggins, J., 2015. 'Real-time monitoring framework to investigate the environmental and structural building performance'. *Building and Environment*, 86, pp. 1-16. <http://dx.doi.org/10.1016/j.buildenv.2014.12.012>

The temperature was measured in the external wall every 1 minute and in the ground/roof slabs every 6 minutes.

The construction of each considered envelope element was completed, accordingly to Figure 14. However, during that period the building was not fully enclosed, with many windows and doors yet to be installed (particularly those located on the first and second floor). Thus, Figure 15 compares the temperature distribution in the monitored envelope elements to the outdoor air temperature [36]. It is clear that changes in the outdoor air temperature significantly influenced the temperature distribution in the external twinwall and the lattice roof slab (Figure 15a, b). There was a clear lag in the wall/slab temperature change in comparison to outdoor air temperature change, i.e. thermal lag. This lag was caused by the thermal mass of the wall/slab, which slowed the heat flow through the element. Figure 15a also shows the temperature of a sample concrete cylinder located inside the building. The cylinder temperature profile matched the wall temperature distribution. However, the cylinder temperature was more influenced by outdoor air temperature than wall temperatures. This was due to lack of any insulation around the cylinder.

Temperatures recorded by the thermistors embedded in the suspended ground floor hollowcore slab did not change significantly over the period monitored and were not influenced by the outdoor air temperature (Figure 15c). This was probably due to the fact that the hollowcore slab was well insulated from the outdoor temperatures by the underfloor void (with low air exchange) on one side, and 60 mm insulation and enclosed ground floor on the other side. This suggests that it is not possible to directly utilise the thermal mass of this type of system to regulate the temperature of the space above the floor. However, if designed correctly, it may be possible to take advantage of the relatively constant temperature of underfloor void as part of a heating and/or cooling system for the indoor environment within the building.

## 5. Conclusions

This paper presents the motivation, objectives and method description of the measurement framework developed at the National University of Ireland (NUI) Galway. This holistic framework was developed in order to continuously monitor the structural and environmental performance of two full-scale demonstration buildings at NUI Galway campus. The proposed monitoring framework has been demonstrated on two large scale educational buildings with mixed mode ventilation systems. However, this framework can also be adapted to other types of operating buildings, e.g. residential. The proposed real-time monitoring has provided rich information about the building performance metrics and ensured the best control strategies for building operation. Moreover, the reliable datasets from those operating buildings, describing their structural and environmental performance, have provided essential support for the generation and calibration of structural/environmental numerical building models in order to optimise building designs and develop cost-

**Please reference as:**

**Hajdukiewicz, M., Byrne, D., Keane, M.M., & Goggins, J., 2015. 'Real-time monitoring framework to investigate the environmental and structural building performance'. *Building and Environment*, 86, pp. 1-16. <http://dx.doi.org/10.1016/j.buildenv.2014.12.012>**

effective sustainable buildings. The monitoring framework employed in the EB have already contributed in a number of projects that investigated thermal comfort of the building occupants [58], [59] or the properties of the novel forms of building systems [44], [47], [56], [57], [60], [62].

The combination of the real-time field measurements in operating buildings, in situ weather monitoring, complementary laboratory experiments and numerical models allowed (i) identification of possible design/operation drawbacks; (ii) proposal of optimised, cost-effective and sustainable designs; and (iii) development of new environmentally friendly and energy efficient structural building systems.

## Acknowledgements

The authors thank Irish Research Council, Oran Pre-Cast Ltd. and Arup Consulting Engineers for the financial support of this research under the Enterprise Partnership Scheme. The last author would like to acknowledge the support of Science Foundation Ireland through the Career Development Award programme (Grant No. 13/CDA/2200). The authors would also like to thank the National University of Ireland Galway and particularly the Department of Civil Engineering in the College of Engineering and Informatics for the help with the instrumentation in the demonstration buildings.

## References

- [1] EEA. Energy and Environment in the European Union: Tracking progress towards integration. Copenhagen, Denmark: European Environment Agency; 2006.
- [2] IEA. International Energy Agency. Official Website; 2014. [Online] Available: <http://www.iea.org/>.
- [3] European Union. Official website of the European Union; 2014. [Online] Available: <http://www.europa.eu>.
- [4] US Department of Energy. 2011 Buildings Energy Data Book. Washington, DC, USA: US Department of Energy; 2012.
- [5] Pérez-Lombard L, Ortiz J, Pout C. A review on buildings energy consumption information. *Energy Build.* 2008; 40(3): 394–398. DOI: 10.1016/j.enbuild.2007.03.007
- [6] European Commission. The Directive 2010/31/EU of the European Parliament and of the Council of May 2010 on the energy performance of buildings. Brussels, Belgium: Official Journal of the European Union; 2010.
- [7] US EPA. United States Environmental Protection Agency. Official Website; 2012. [Online] Available: <http://www.epa.gov/>.
- [8] Berardi U. Sustainability Assessment in the Construction Sector: Rating Systems and Rated Buildings. *Sustain. Dev.* 2012; 20(6): 411–424.
- [9] Jang WS, Healy WM, Skibniewski MJ. Wireless sensor networks as part of a web-based building environmental monitoring system. *Autom. Constr.* 2008; 17(6): 729–736.
- [10] Sharmin T, Gül M, Li X, Ganev V, Nikolaidis I, Al-Hussein M. Monitoring building energy consumption, thermal performance, and indoor air quality in a cold climate region. *Sustain. Cities Soc.* 2014; 13: 57–68.
- [11] Painter B, Brown N, Cook MJ. Practical application of a sensor overlay system for building monitoring and commissioning. *Energy Build.* 2012; 48: 29–39.

**Please reference as:**

**Hajdukiewicz, M., Byrne, D., Keane, M.M., & Goggins, J., 2015. 'Real-time monitoring framework to investigate the environmental and structural building performance'. *Building and Environment*, 86, pp. 1-16. <http://dx.doi.org/10.1016/j.buildenv.2014.12.012>**

- [12] Sun Y, Wang Z. The energy consumption monitoring platform design for large-scale industry users based on the GPRS. In the Proceedings of The 2nd International Conference on Mechanic Automation and Control Engineering. Inner Mongolia, China; 15-17 July 2011, 7827–7830.
- [13] Zhao L, Zhang J, Liang R. Development of an energy monitoring system for large public buildings Energy Build. 2013; 66: 41–48.
- [14] Sučić B, Anđelković AS, Tomšić Ž. The concept of an integrated performance monitoring system for promotion of energy awareness in buildings. Energy Build. 2014; (*in press*).
- [15] Köppe E, Bartholmai M. Wireless Sensor Network with Temperature Compensated Measuring Technology for Long-Term Structural Health Monitoring of Buildings and Infrastructures. Procedia Eng. 2011; 25: 1032–1036.
- [16] Xia Y, Hao H, Zanardo G, Deeks A. Long term vibration monitoring of an RC slab: Temperature and humidity effect. Eng. Struct. 2006; 28(3): 441–452.
- [17] Yuen KV, Kuok SC. Ambient interference in long-term monitoring of buildings. Eng. Struct. 2010; 32(8): 2379–2386.
- [18] Kurata N, Suzuki M, Saruwatari S, Morikawa H. Actual application of ubiquitous structural monitoring system using wireless sensor networks. In the Proceedings of the 14th World Conference on Earthquake Engineering. Beijing, China. 2008.
- [19] Trifunac MD, Ebrahimian M. Detection thresholds in structural health monitoring. Soil Dyn. Earthq. Eng. 2014; 66: 319–338.
- [20] Lynch JP, Law KH, Kiremidjian AS, Carryer E, Farrar CR, Sohn H, Allen DW, Nadler B, Wait JR. Design and performance validation of a wireless sensing unit for structural monitoring applications. Struct. Eng. Mech. 2004; 17(3–4).
- [21] Catbas FN, Susoy M, Frangopol DM. Structural health monitoring and reliability estimation: Long span truss bridge application with environmental monitoring data. Eng. Struct. 2008; 30(9): 2347–2359.
- [22] Inaudi D. Chapter 11. Structural health monitoring of bridges: general issues and applications. Structural Health Monitoring of Civil Infrastructure Systems. Elsevier, 2009; 339–370.
- [23] Stefano ADE, Clemente P. Chapter 13. Structural health monitoring of historical structures. Structural Health Monitoring of Civil Infrastructure Systems. Elsevier, 2009; 412–434.
- [24] Habel WR. Chapter 14. Structural health monitoring research in Europe: trends and applications. Structural Health Monitoring of Civil Infrastructure Systems. Elsevier, 2009; 435–462.
- [25] Fuhr PL, Huston DR, Kajenski PJ, Ambrose TP. Performance and health monitoring of the Stafford Medical Building using embedded sensors. Smart Mater. Struct. 1992; 1(1): 63–68.
- [26] Unzu R, Nazabal JA, Vargas G, Hernández RJ, Fernández-Valdivielso C, Urriza N, Galarza M, Lopez-Amo M. Fiber optic and KNX sensors network for remote monitoring a new building cladding system. Autom. Constr. 2013; 30: 9–14.
- [27] IPCA. Precast concrete: Frames guide. Dublin, Ireland: Irish Precast Concrete Association; 2005.
- [28] ICS and ICF. The new concrete standards: An introduction to EN 206-1. Drogheda, Ireland: Irish Concrete Society and Dublin, Ireland: Irish Concrete Federation; 2004.
- [29] ICF. Concrete for energy efficient buildings: The benefits of thermal mass. Dublin, Ireland: Irish Concrete Federation; 2008.
- [30] Gage Technique. Geotechnical and structural instrumentation. Official Website; 2014. [Online] Available: <http://www.gage-technique.com/>.
- [31] TML. Tokyo Sokki Kenkyujo Co. Ltd. Official Website; 2014. [Online] Available: <http://www.tml.jp/>.
- [32] ATC Semitec. Thermal components. Official Website; 2014. [Online] Available: [www.atcsemitec.co.uk](http://www.atcsemitec.co.uk).
- [33] Campbell Scientific. Measurement and control products for long-term monitoring. Official Website; 2014. [Online] Available: <http://www.campbellsci.co.uk/>.
- [34] Onset. Computer Corporation. Official Website; 2014. [Online] Available: <http://www.onsetcomp.com/>.

**Please reference as:**

**Hajdukiewicz, M., Byrne, D., Keane, M.M., & Goggins, J., 2015. 'Real-time monitoring framework to investigate the environmental and structural building performance'. *Building and Environment*, 86, pp. 1-16. <http://dx.doi.org/10.1016/j.buildenv.2014.12.012>**

- [35] FLIR. Thermal imaging. Official Website; 2014. [Online] Available: <http://www.flir.com/IE/>.
- [36] IRUSE Weather. Informatics Research Unit for Sustainable Engineering NUI Galway Weather Website; 2014. [Online] Available: <http://weather.nuigalway.ie/>.
- [37] Everiss R. NUIG Weather App. Galway, Ireland: Smartphone and iPhone application. 2014.
- [38] CEN. EN 12390: Testing hardened concrete - Part 2 : Making and curing specimens for strength tests,” Brussels, Belgium: European Committee for Standardization; 2009.
- [39] CEN. EN 12390: Testing hardened concrete - Part 3 : Compressive strength of test specimens. Brussels, Belgium: European Committee for Standardization; 2009.
- [40] CEN. EN 12390: Testing hardened concrete - Part 6 : Tensile splitting strength of test specimens. Brussels, Belgium: European Committee for Standardization; 2009.
- [41] CEN. EN 12390: Testing hardened concrete - Part 13 : Determination of secant modulus of elasticity in compression. Brussels, Belgium: European Committee for Standardization; 2013.
- [42] AASHTO. T336: Coefficient of thermal expansion of hydraulic cement concrete. Washington, DC, USA: American Association of State and Highway Transportation Officials; 2011.
- [43] ACI. Guide to thermal properties of concrete and masonry systems. ACI 122R-02. Farmington Hills, MI, USA: American Concrete Institute; 2002.
- [44] Goggins J, Newell S, King D, Hajdukiewicz M. Real-time monitoring of a hybrid precast and in situ concrete flat slab system. In the Proceedings of Conference of Civil Engineering Research in Ireland; CERI 2014. Belfast, Northern Ireland; 28-29 August 2014.
- [45] Goggins J, Byrne D, Cannon E. The creation of a living laboratory for structural engineering at the National University of Ireland, Galway. *Struct. Eng.* 2012; 90(4).
- [46] Cobiax. Voided concrete slabs. Official Website; 2014. [Online] Available: <http://www.cobiax.ch/>.
- [47] Byrne D. The analysis of shear and load transfer in void form flat slab systems, through in-situ measurements from buildings and numerical modelling. PhD Thesis; College of Engineering and Informatics, National University of Ireland Galway; (*planned submission for 2015*).
- [48] Cylon. Smart energy control. Official Website; 2014. [Online] Available: <http://www.cylon.com/ie/>.
- [49] MySQL. Open source database. Official Website; 2014. [Online] Available: <http://www.mysql.com/>.
- [50] IRUSE. Informatics Research Unit for Sustainable Engineering. Official Website; 2014. [Online] Available: <http://www.iruse.ie>.
- [51] Bamforth, P. Early-age thermal crack control in concrete. CIRIA Report C660. London, UK: Construction, Built Environment, Civil Engineering; 2007.
- [52] CEN. EN 1992-1-1: Eurocode 2: Design of concrete structures. General rules and rules for buildings. Brussels, Belgium: European Committee for Standardization; 2004.
- [53] ACI. Prediction of creep, shrinkage and temperature effects in concrete structures. ACI 209R-92. Farmington Hills, MI, USA: American Concrete Institute; 1992.
- [54] Wojnowska A, Alawadhi H. On the use of concrete structural elements with passive ventilation techniques to minimise the energy usage in buildings. BE Thesis; College of Engineering and Informatics, National University of Ireland Galway; 2013.
- [55] O'Connor P, O'Neill C. Real-time control of internal building environments. BE Thesis; College of Engineering and Informatics, National University of Ireland, Galway; 2014.
- [56] Byrne D, Goggins J, Cannon E. The analysis of time dependent effects of concrete systems through in-situ structural health monitoring. In the Proceedings of Global Thinking in Structural Engineering: Recent Achievements Conference; IABSE 2012. Sharm-El Sheikh, Egypt; 7-8 May 2012.
- [57] Byrne D, Goggins J. The use of in-situ instrumentation in determining optimum retrofitting solutions of concrete structural elements. *Key Eng. Mater. J.* 2013; 569: 382–389.

**Please reference as:**

**Hajdukiewicz, M., Byrne, D., Keane, M.M., & Goggins, J., 2015. 'Real-time monitoring framework to investigate the environmental and structural building performance'. *Building and Environment*, 86, pp. 1-16. <http://dx.doi.org/10.1016/j.buildenv.2014.12.012>**

- [58] Hajdukiewicz M, Geron M, Keane MM. Calibrated CFD simulation to evaluate thermal comfort in a highly-glazed naturally ventilated room. *Build. Environ.* 2013; 70: 73–89. DOI: 10.1016/j.buildenv.2013.08.020
- [59] Coakley D, Corry EJ, Keane MM. Validation of simulated thermal comfort using a calibrated building energy simulation (BES) model in the context of building performance evaluation and optimisation. In the Proceedings of International Conference for Enhanced Building Operations; ICEBO 2013. Montreal, Canada; 8-11 October 2013.
- [60] Hajdukiewicz M, Goggins J. The influence of heat transfer and storage in structural precast building components on indoor environments. In the Proceedings of Conference of Civil Engineering Research in Ireland; CERI 2014. Belfast, Northern Ireland; 28-29 August 2014.
- [61] Oran Pre-Cast Ltd. Total pre-cast solutions. Official Website; 2014. [Online] Available: <http://www.oranprecast.ie/>.
- [62] Hajdukiewicz M, Lebrene J, Goggins J. The environmental performance of a reinforced precast concrete slab with void forming system. In the Proceedings of International Conference on Construction Materials and Structures; ICCMATS 2014. Johannesburg, South Africa; 24-26 November 2014.

**Please reference as:**

**Hajdukiewicz, M., Byrne, D., Keane, M.M., & Goggins, J., 2015. 'Real-time monitoring framework to investigate the environmental and structural building performance'. *Building and Environment*, 86, pp. 1-16. <http://dx.doi.org/10.1016/j.buildenv.2014.12.012>**